

200 V - 1.5 A ultrafast recovery diode

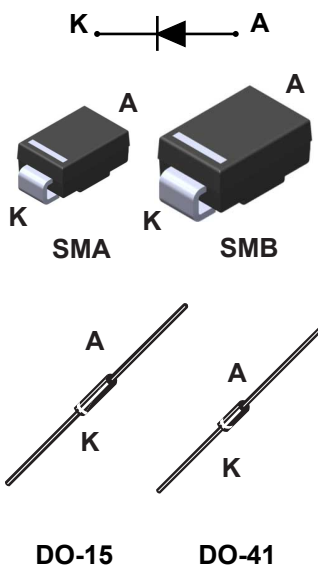

Features

- Very low conduction losses
- Negligible switching losses
- Low forward voltage drop
- High junction temperature
- ECOPACK^{®2}

Applications

- Switching diode
- LED Lighting
- Auxiliary power supply
- Flyback diode

Description

The **STTH1R02** uses ST's new 200 V planar Pt doping technology, and it is specially suited for switching mode base drive and transistor circuits.

Packaged in SMA, SMB, DO-41 and DO-15, the **STTH1R02** is ideal for use low voltage, high frequency inverters, free wheeling and polarity protection

| Product status | |
|-----------------|--------|
| STTH1R02 | |
| Product summary | |
| Symbol | Value |
| $I_{F(AV)}$ | 1.5 A |
| V_{RRM} | 200 V |
| $T_{j(max.)}$ | 175 °C |
| $V_{F(typ.)}$ | 0.7 V |
| $t_{rr(typ.)}$ | 15 ns |

1 Characteristics

Table 1. Absolute ratings (limiting values at 25 °C, unless otherwise specified)

| Symbol | Parameter | | Value | Unit | |
|-------------|--|--------------|---------------------------------|------|---|
| V_{RRM} | Repetitive peak reverse voltage | | 200 | V | |
| $I_{F(AV)}$ | Average forward current $\delta = 0.5$, square wave | SMA, SMB | $T_L = 150\text{ °C}$ | 1.5 | A |
| | | DO-41, DO-15 | $T_L = 135\text{ °C}$ | | |
| I_{FSM} | Surge non repetitive forward current | | $t_p = 10\text{ ms}$ sinusoidal | 60 | A |
| T_{stg} | Storage temperature range | | -65 to +175 | °C | |
| T_j | Operating junction temperature | | +175 | °C | |

Table 2. Thermal resistance parameter

| Symbol | Parameter | | Max. value | Unit | |
|---------------|------------------|--|--------------|------|------|
| $R_{th(j-l)}$ | Junction to lead | | SMA, SMB | 30 | °C/W |
| $R_{th(j-l)}$ | Junction to lead | Lead length = 10 mm on infinite heatsink | DO-15, DO-41 | 45 | |

For more information, please refer to the following application note :

- AN5088 : Rectifiers thermal management, handling and mounting recommendations

Table 3. Static electrical characteristics

| Symbol | Parameter | Test conditions | | Min. | Typ. | Max. | Unit |
|-------------|-------------------------|-----------------------|----------------------|------|------|------|---------------|
| $I_R^{(1)}$ | Reverse leakage current | $T_j = 25\text{ °C}$ | $V_R = V_{RRM}$ | - | | 3 | μA |
| | | $T_j = 125\text{ °C}$ | | - | 2 | 20 | |
| $V_F^{(2)}$ | Forward voltage drop | $T_j = 25\text{ °C}$ | $I_F = 1.5\text{ A}$ | - | 0.89 | 1.00 | V |
| | | $T_j = 100\text{ °C}$ | | - | 0.76 | 0.85 | |
| | | $T_j = 150\text{ °C}$ | | - | 0.70 | 0.80 | |

1. Pulse test: $t_p = 5\text{ ms}$, $\delta < 2\%$

2. Pulse test: $t_p = 380\text{ }\mu\text{s}$, $\delta < 2\%$

To evaluate the conduction losses, use the following equation:

$$P = 0.68 \times I_{F(AV)} + 0.08 \times I_F^2(RMS)$$

For more information, please refer to the following application notes related to the power losses :

- AN604: Calculation of conduction losses in a power rectifier
- AN4021: Calculation of reverse losses on a power diode

Table 4. Dynamic characteristics ($T_j = 25\text{ °C}$ unless otherwise stated)

| Symbol | Parameters | Test conditions | Min. | Typ. | Max. | Unit |
|----------|--------------------------|---|------|------|------|------|
| t_{rr} | Reverse recovery time | $I_F = 1\text{ A}$, $di_F/dt = -50\text{ A}/\mu\text{s}$, $V_R = 30\text{ V}$ | - | 23 | 30 | ns |
| | | $I_F = 1\text{ A}$, $di_F/dt = -100\text{ A}/\mu\text{s}$, $V_R = 30\text{ V}$ | - | 15 | 20 | |
| I_{RM} | Reverse recovery current | $I_F = 1.5\text{ A}$, $di_F/dt = -200\text{ A}/\mu\text{s}$, $V_R = 160\text{ V}$, $T_j = 125\text{ °C}$ | - | 3 | 4 | A |
| t_{fr} | Forward recovery time | $I_F = 1.5\text{ A}$, $di_F/dt = 100\text{ A}/\mu\text{s}$, $V_{FR} = 1.1 V_{F(max.)}$ | - | 50 | | ns |
| V_{FP} | Forward recovery voltage | $I_F = 1.5\text{ A}$, $di_F/dt = 100\text{ A}/\mu\text{s}$ | - | 2.1 | | V |

1.1 Characteristics (curves)

Figure 1. Peak current versus duty cycle

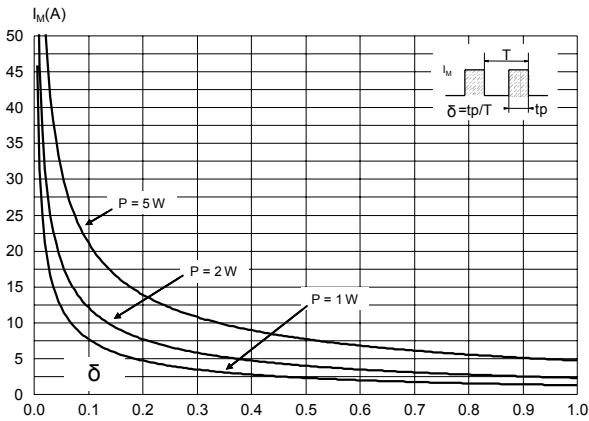

Figure 2. Forward voltage drop versus forward current (typical values)

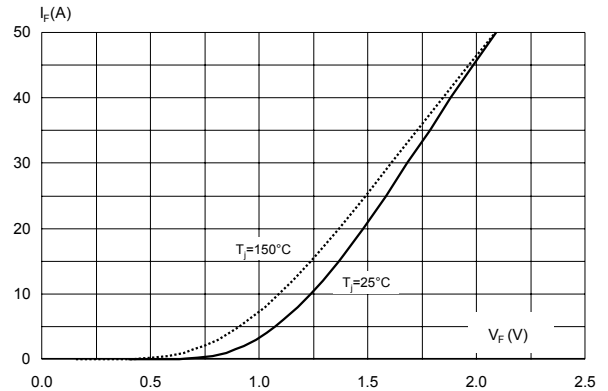

Figure 3. Forward voltage drop versus forward current (maximum values)

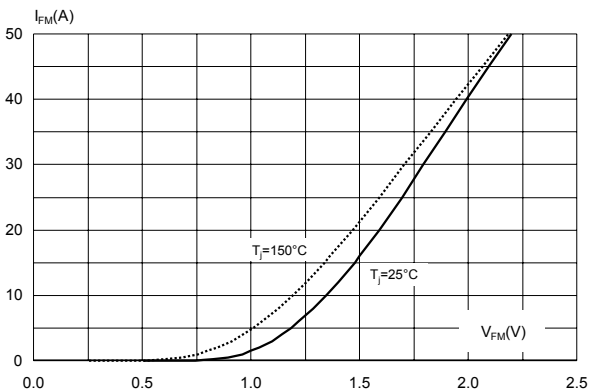

Figure 4. Relative variation of thermal impedance junction to lead versus pulse duration (SMA)

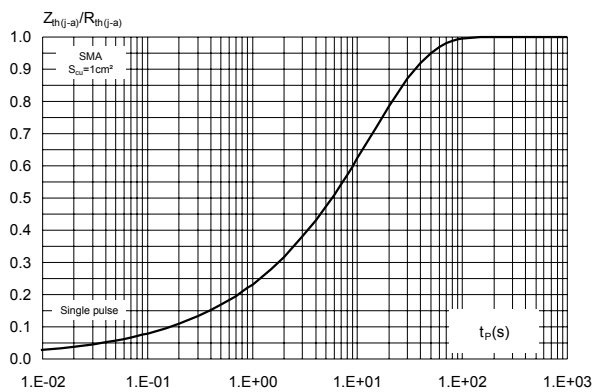

Figure 5. Relative variation of thermal impedance junction to lead versus pulse duration (SMB)

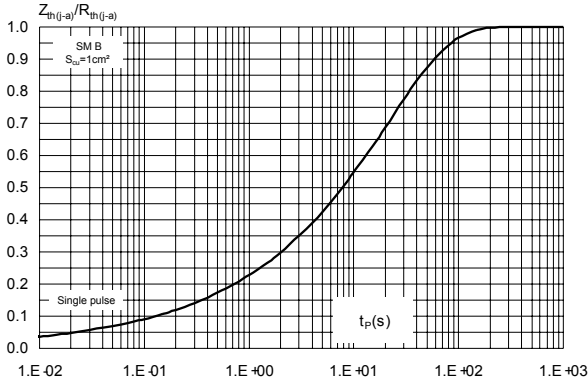

Figure 6. Relative variation of thermal impedance junction to lead versus pulse duration (DO-41)

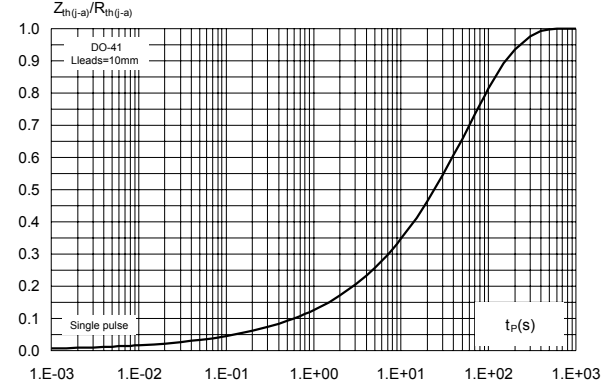

Figure 7. Relative variation of thermal impedance junction to lead versus pulse duration (DO-15)

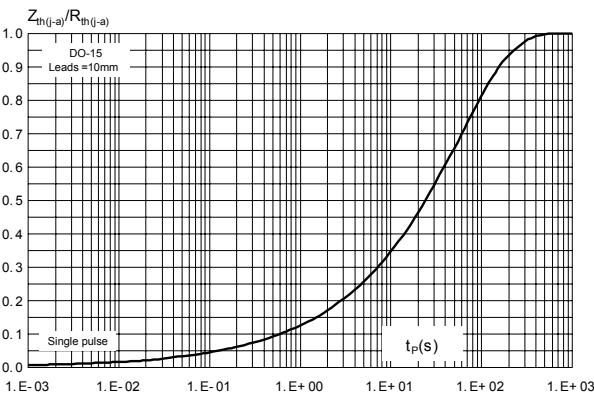

Figure 8. Junction capacitance versus reverse voltage applied (typical values)

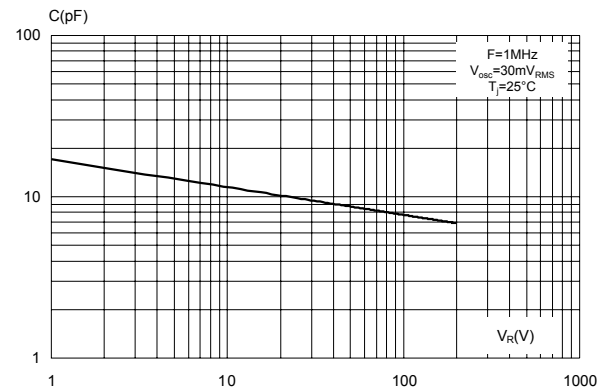

Figure 9. Reverse recovery charges versus di_F/dt (typical values)

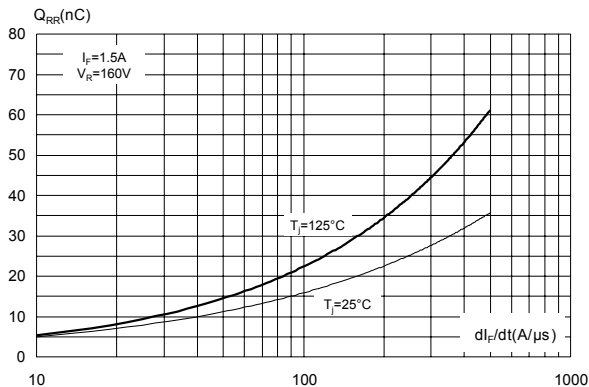

Figure 10. Reverse recovery time versus di_F/dt (typical values)

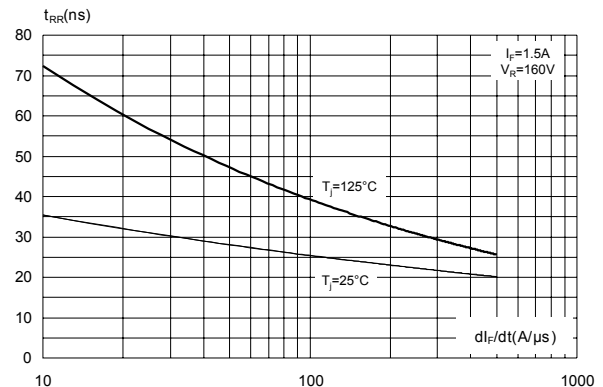

Figure 11. Peak reverse recovery current versus di_F/dt (typical values)

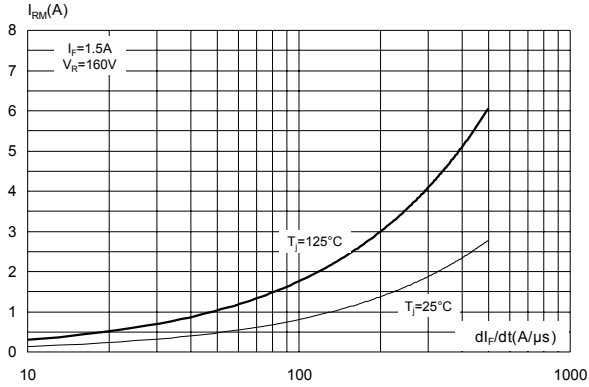

Figure 12. Relative variations of dynamic parameters versus junction temperature

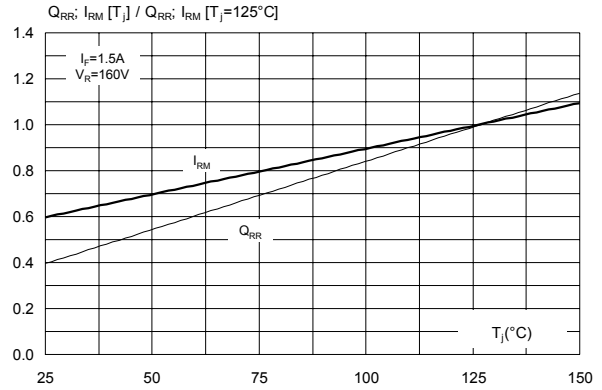

Figure 13. Thermal resistance junction to ambient versus copper surface under each lead (typical values)

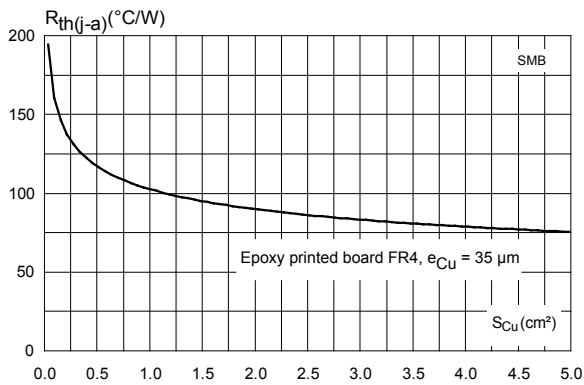

Figure 14. Thermal resistance junction to ambient versus copper surface under each lead (typical values)

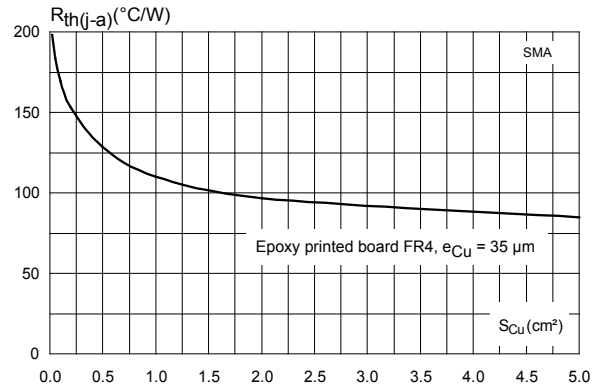

Figure 15. Thermal resistance junction to ambient versus lead length (DO-41)

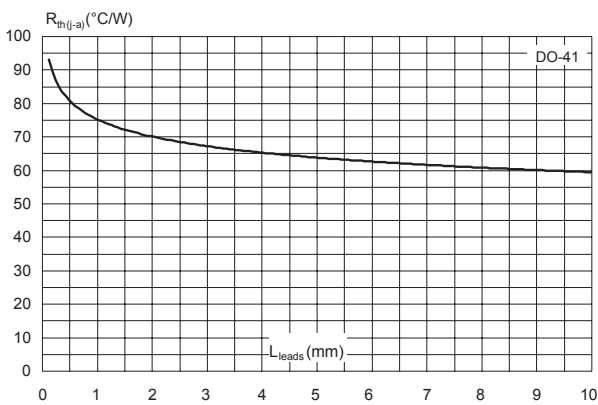
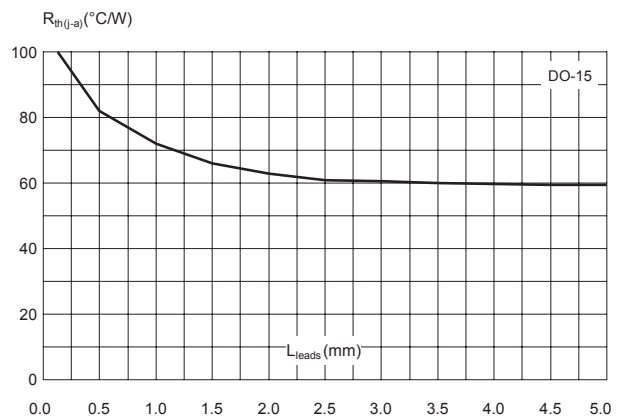

Figure 16. Thermal resistance junction to ambient versus lead length (DO-15)



2 Package information

In order to meet environmental requirements, ST offers these devices in different grades of ECOPACK[®] packages, depending on their level of environmental compliance. ECOPACK[®] specifications, grade definitions and product status are available at: www.st.com. ECOPACK[®] is an ST trademark.

2.1 SMB package information

- Epoxy meets UL94, V0
- Lead-free package

Figure 17. SMB package outline

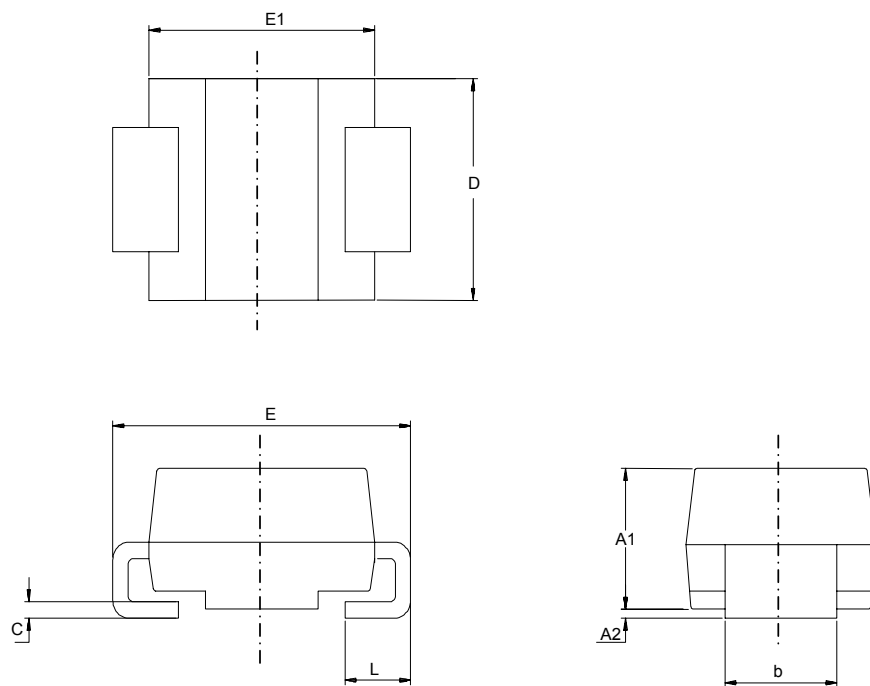
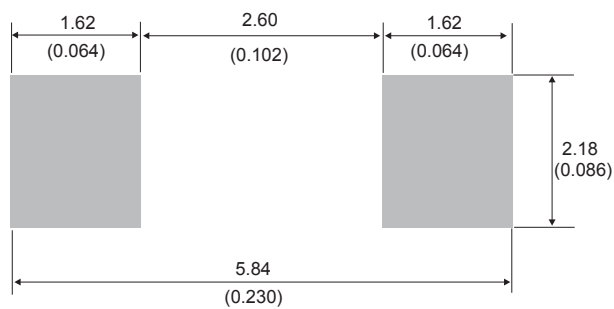

Table 5. SMB package mechanical data

| Ref. | Dimensions | | | |
|------|-------------|------|-----------------------------|-------|
| | Millimeters | | Inches (for reference only) | |
| | Min. | Max. | Min. | Max. |
| A1 | 1.90 | 2.45 | 0.074 | 0.097 |
| A2 | 0.05 | 0.20 | 0.001 | 0.008 |
| b | 1.95 | 2.20 | 0.076 | 0.087 |
| c | 0.15 | 0.40 | 0.005 | 0.016 |
| D | 3.30 | 3.95 | 0.129 | 0.156 |
| E | 5.10 | 5.60 | 0.200 | 0.221 |
| E1 | 4.05 | 4.60 | 0.159 | 0.182 |
| L | 0.75 | 1.50 | 0.029 | 0.060 |

Figure 18. SMB recommended footprint



2.2 SMA package information

- Epoxy meets UL94, V0
- Cooling method : by conduction (C)

Figure 19. SMA package outline

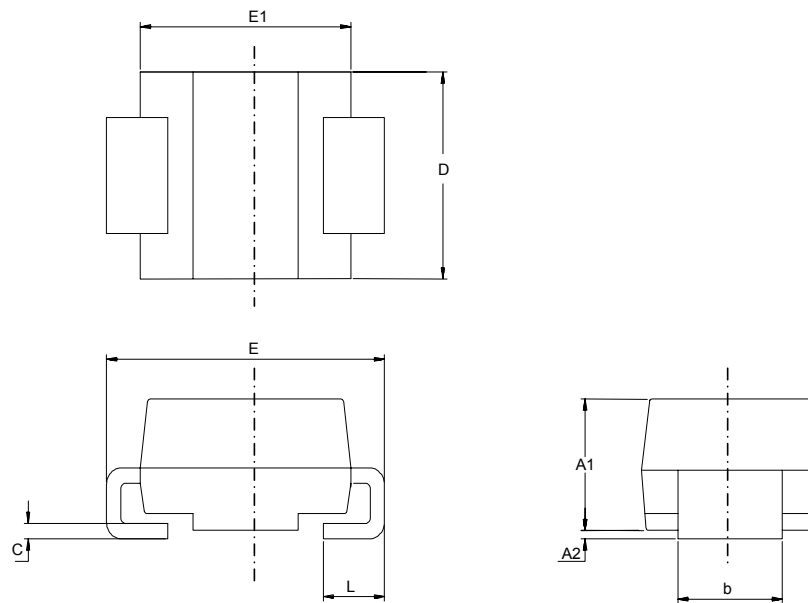
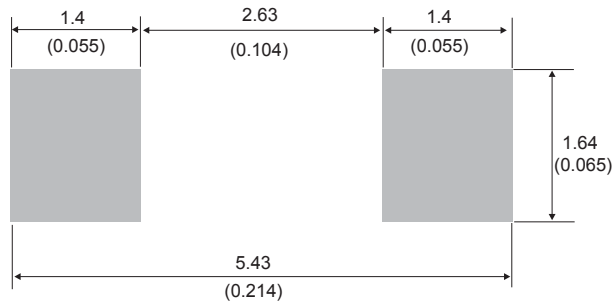

Table 6. SMA package mechanical data

| Ref. | Dimensions | | | |
|------|-------------|------|-----------------------------|-------|
| | Millimeters | | Inches (for reference only) | |
| | Min. | Max. | Min. | Max. |
| A1 | 1.90 | 2.45 | 0.074 | 0.097 |
| A2 | 0.05 | 0.20 | 0.001 | 0.008 |
| b | 1.25 | 1.65 | 0.049 | 0.065 |
| c | 0.15 | 0.40 | 0.005 | 0.016 |
| D | 2.25 | 2.90 | 0.088 | 0.115 |
| E | 4.80 | 5.35 | 0.188 | 0.211 |
| E1 | 3.95 | 4.60 | 0.155 | 0.182 |
| L | 0.75 | 1.50 | 0.029 | 0.060 |

Figure 20. SMA recommended footprint in mm (inches)



2.3 DO-41 package information

- Epoxy meets UL 94, V0

Figure 21. DO-41 package outline

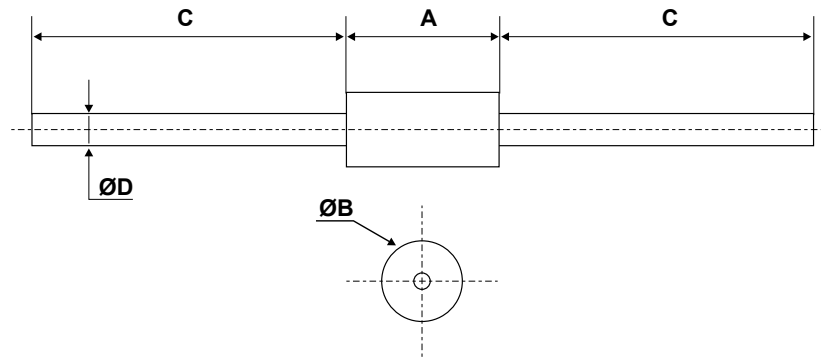

Table 7. DO-41 package mechanical data

| Ref. | Dimensions | | | | | |
|------|-------------|------|------|-----------------------------|------|--------|
| | Millimeters | | | Inches (for reference only) | | |
| | Min. | Typ. | Max. | Min. | Typ. | Max. |
| A | 4.07 | - | 5.20 | 0.160 | - | 0.205 |
| B | 2.04 | - | 2.71 | 0.080 | - | 0.107 |
| C | 25.40 | - | | 1.000 | - | |
| D | 0.71 | - | 0.86 | 0.028 | - | 0.0034 |

2.4 DO-15 package information

- Epoxy meets UL 94, V0

Figure 22. DO-15 package outline

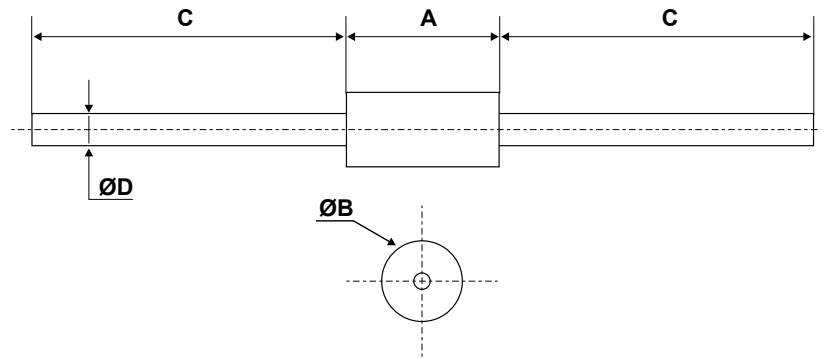

Table 8. DO-15 package mechanical data

| Ref. | Dimensions | | | | | |
|------|-------------|------|-------|-----------------------------|------|--------|
| | Millimeters | | | Inches (for reference only) | | |
| | Min. | Typ. | Max. | Min. | Typ. | Max. |
| A | 6.05 | - | 6.75 | 0.238 | - | 0.266 |
| B | 2.95 | - | 3.53 | 0.116 | - | 0.139 |
| C | 26.00 | - | 31.00 | 1.024 | - | 1.220 |
| D | 0.71 | - | 0.88 | 0.028 | - | 0.0035 |

3 Ordering information

Table 9. Ordering information

| Order code | Marking | Package | Weight | Base qty. | Delivery mode |
|-------------|-----------|---------|---------|-----------|---------------|
| STTH1R02A | R1A | SMA | 0.068 g | 5000 | Tape and reel |
| STTH1R02U | 1R2S | SMB | 0.107 g | 2500 | Tape and reel |
| STTH1R02 | STTH1R02 | DO-41 | 0.34 g | 2000 | Ammopack |
| STTH1R02RL | STTH1R02 | DO-41 | 0.34 g | 5000 | Tape and reel |
| STTH1R02Q | STTH1R02Q | DO-15 | 0.40 g | 1000 | Ammopack |
| STTH1R02QRL | STTH1R02Q | DO-15 | 0.40 g | 6000 | Tape and reel |

Revision history

Table 10. Document revision history

| Date | Revision | Changes |
|-------------|----------|--|
| 03-May-2006 | 1 | First issue. |
| 13-Oct-2006 | 2 | Added DO-15 and SMB packages. |
| 08-Mar-2007 | 3 | Replaced Figure 8. Replaced ecu with copper thickness. |
| 05-Dec-2018 | 4 | Updated Section Applications . Minor text changes. |

IMPORTANT NOTICE – PLEASE READ CAREFULLY

STMicroelectronics NV and its subsidiaries (“ST”) reserve the right to make changes, corrections, enhancements, modifications, and improvements to ST products and/or to this document at any time without notice. Purchasers should obtain the latest relevant information on ST products before placing orders. ST products are sold pursuant to ST’s terms and conditions of sale in place at the time of order acknowledgement.

Purchasers are solely responsible for the choice, selection, and use of ST products and ST assumes no liability for application assistance or the design of Purchasers’ products.

No license, express or implied, to any intellectual property right is granted by ST herein.

Resale of ST products with provisions different from the information set forth herein shall void any warranty granted by ST for such product.

ST and the ST logo are trademarks of ST. All other product or service names are the property of their respective owners.

Information in this document supersedes and replaces information previously supplied in any prior versions of this document.

© 2018 STMicroelectronics – All rights reserved

单击下面可查看定价，库存，交付和生命周期等信息

[>>STMicro\(意法半导体\)](#)