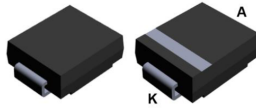

## 1500 W TVS in SMC

 SMC  
(JEDEC DO-214AB)

 Bidirectional  
(CA type)

 Unidirectional  
(A type)

## Features

- Peak pulse power:
  - 1500 W (10/1000  $\mu$ s)
  - up to 10 kW (8/20  $\mu$ s)
- Stand-off voltage range from 5 V to 188 V
- Unidirectional and bidirectional types
- Low leakage current: 0.2  $\mu$ A at 25 °C
- Operating  $T_j$  max: 150 °C
- High power capability at  $T_j$  max.: up to 1250 W (10/1000  $\mu$ s)
- Lead finishing: matte tin plating

## Complies with the following standards

- UL94, V0
- J-STD-020 MSL level 1
- J-STD-002, JESD 22-B102 E3 and MIL-STD-750, method 2026
- JESD-201 class 2 whisker test
- IPC7531 footprint and JEDEC registered package outline
- UL 497B file number: QVGQ2.E136224
- IEC 61000-4-4 level 4:
  - 4 kV
- IEC 61000-4-2, C = 150 pF, R = 330  $\Omega$  exceeds level 4:
  - 30 kV (air discharge)
  - 30 kV (contact discharge)

## Description

The SM15T TVS series is designed to protect sensitive equipment against electrostatic discharges according to IEC 61000-4-2, MIL STD 883 Method 3015, and electrical overstress such as IEC 61000-4-4 and 5. They are used for surges below 1500 W 10/1000  $\mu$ s.

This planar technology makes it compatible with high-end equipment and SMPS where low leakage current and high junction temperature are required to provide reliability and stability over time.

## Product status link

|       |  |
|-------|--|
| SM15T | SM15T6V8A , SM15T6V8CA ,<br>SM15T7V5A , SM15T7V5CA ,<br>SM15T10A , SM15T10CA ,<br>SM15T12A , SM15T12CA ,<br>SM15T15A , SM15T15CA ,<br>SM15T18A , SM15T18CA ,<br>SM15T22A , SM15T22CA ,<br>SM15T24A , SM15T24CA ,<br>SM15T27A , SM15T27CA ,<br>SM15T30A , SM15T30CA ,<br>SM15T33A , SM15T33CA ,<br>SM15T36A , SM15T36CA ,<br>SM15T39A , SM15T39CA ,<br>SM15T68A , SM15T68CA ,<br>SM15T75A , SM15T75CA ,<br>SM15T100A , SM15T100CA ,<br>SM15T150A , SM15T150CA ,<br>SM15T200A , SM15T200CA ,<br>SM15T220A , SM15T220CA |
|-------|--|

# 1 Characteristics

**Table 1. Absolute maximum ratings ( $T_{amb} = 25\text{ }^{\circ}\text{C}$ )**

| Symbol    | Parameter  | Value   | Unit        |                    |
|-----------|--|---|-------------|--------------------|
| $V_{PP}$  | Peak pulse voltage                                 | IEC 61000-4-2 (C = 150 pF, R = 330 $\Omega$ ) |             |                    |
|           |  | Contact discharge                             | 30          | kV                 |
|           |  | Air discharge                                 | 30          |                    |
| $P_{PP}$  | Peak pulse power dissipation                       | $T_j$ initial = $T_{amb}$                     | 1500        | W                  |
| $T_{stg}$ | Storage temperature range                          |   | -65 to +150 | $^{\circ}\text{C}$ |
| $T_j$     | Operating junction temperature range               |   | -55 to +150 | $^{\circ}\text{C}$ |
| $T_L$     | Maximum lead temperature for soldering during 10 s |   | 260         | $^{\circ}\text{C}$ |

**Figure 1. Electrical characteristics - parameter definitions**

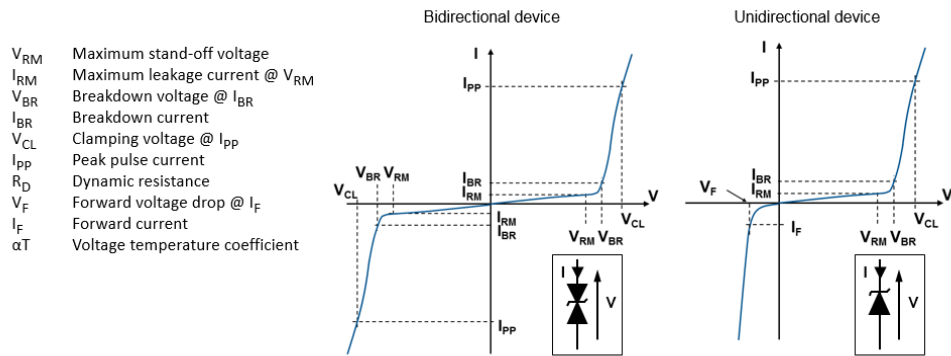

**Figure 2. Pulse definition for electrical characteristics**

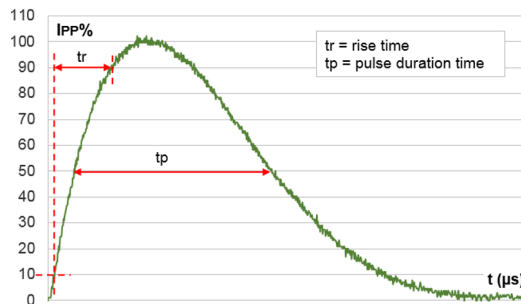

**Table 2. Electrical characteristics - parameter values ( $T_{amb} = 25\text{ °C}$ , unless otherwise specified)**

| Type         | $I_{RM}$ max at $V_{RM}$ |         |      | $V_{BR}$ at $I_{BR}^{(1)}$ |      |      |    | 10 / 1000 $\mu$ s |                |          | 8 / 20 $\mu$ s    |                |          | $\alpha T$          |
|--------------|--------------------------|---------|------|----------------------------|------|------|----|-------------------|----------------|----------|-------------------|----------------|----------|---------------------|
|              | 25 °C                    | 85 °C   |      | Min.                       | Typ. | Max. |    | $V_{CL}^{(2)(3)}$ | $I_{PP}^{(4)}$ | $R_D$    | $V_{CL}^{(2)(3)}$ | $I_{PP}^{(4)}$ | $R_D$    |                     |
|              | $\mu$ A                  | $\mu$ A | V    | V                          |      |      | mA | Max.              |                | Max.     | Max.              |                | Max.     | Max.                |
|              |                          |         |      |                            |      |      |    | V                 | A              | $\Omega$ | V                 | A              | $\Omega$ | $10^{-4}/\text{°C}$ |
| SM15T6V8A/CA | 500                      | 2000    | 5.8  | 6.45                       | 6.8  | 7.14 | 10 | 10.5              | 143            | 0.023    | 13.4              | 746            | 0.008    | 5.7                 |
| SM15T7V5A/CA | 250                      | 1000    | 6.4  | 7.13                       | 7.5  | 7.88 | 10 | 11.3              | 132            | 0.026    | 14.5              | 690            | 0.010    | 6.1                 |
| SM15T10A/CA  | 10                       | 50      | 8.55 | 9.5                        | 10   | 10.5 | 1  | 14.5              | 103            | 0.039    | 18.6              | 538            | 0.015    | 7.3                 |
| SM15T12A/CA  | 0.2                      | 1       | 10.2 | 11.4                       | 12   | 12.6 | 1  | 16.7              | 90             | 0.046    | 21.7              | 461            | 0.020    | 7.8                 |
| SM15T15A/CA  | 0.2                      | 1       | 12.8 | 14.3                       | 15   | 15.8 | 1  | 21.2              | 71             | 0.076    | 27.2              | 368            | 0.031    | 8.4                 |
| SM15T18A/CA  | 0.2                      | 1       | 15.3 | 17.1                       | 18   | 18.9 | 1  | 25.2              | 59.5           | 0.106    | 32.5              | 308            | 0.044    | 8.8                 |
| SM15T22A/CA  | 0.2                      | 1       | 18.8 | 20.9                       | 22   | 23.1 | 1  | 30.6              | 49             | 0.153    | 39.3              | 254            | 0.064    | 9.2                 |
| SM15T24A/CA  | 0.2                      | 1       | 20.5 | 22.8                       | 24   | 25.2 | 1  | 33.2              | 45             | 0.178    | 42.8              | 234            | 0.075    | 9.4                 |
| SM15T27A/CA  | 0.2                      | 1       | 23.1 | 25.7                       | 27   | 28.4 | 1  | 37.5              | 40             | 0.228    | 48.3              | 207            | 0.096    | 9.6                 |
| SM15T30A/CA  | 0.2                      | 1       | 25.6 | 28.5                       | 30   | 31.5 | 1  | 41.5              | 36             | 0.278    | 53.5              | 187            | 0.12     | 9.7                 |
| SM15T33A/CA  | 0.2                      | 1       | 28.2 | 31.4                       | 33   | 34.7 | 1  | 45.7              | 33             | 0.333    | 59.0              | 169            | 0.14     | 9.8                 |
| SM15T36A/CA  | 0.2                      | 1       | 30.8 | 34.2                       | 36   | 37.8 | 1  | 49.9              | 30             | 0.403    | 64.3              | 156            | 0.17     | 9.9                 |
| SM15T39A/CA  | 0.2                      | 1       | 33.3 | 37.1                       | 39   | 41.0 | 1  | 53.9              | 28             | 0.461    | 69.7              | 143            | 0.20     | 10.0                |
| SM15T68A/CA  | 0.2                      | 1       | 58.1 | 64.6                       | 68   | 71.4 | 1  | 92                | 16.3           | 1.26     | 121               | 83             | 0.60     | 10.4                |
| SM15T75A/CA  | 0.2                      | 1       | 64.1 | 71.3                       | 75   | 78.8 | 1  | 103               | 14.6           | 1.66     | 134               | 75             | 0.74     | 10.5                |
| SM15T100A/CA | 0.2                      | 1       | 85.5 | 95.0                       | 100  | 105  | 1  | 137               | 11             | 2.91     | 178               | 56             | 1.30     | 10.6                |
| SM15T150A/CA | 0.2                      | 1       | 128  | 143                        | 150  | 158  | 1  | 207               | 7.2            | 6.81     | 265               | 38             | 2.82     | 10.8                |
| SM15T200A/CA | 0.2                      | 1       | 171  | 190                        | 200  | 210  | 1  | 274               | 5.5            | 11.6     | 353               | 28             | 5.11     | 10.8                |
| SM15T220A/CA | 0.2                      | 1       | 188  | 209                        | 220  | 231  | 1  | 328               | 4.6            | 21.1     | 388               | 26             | 6.04     | 10.8                |

1. To calculate  $V_{BR}$  versus  $T_j$ :  $V_{BR}$  at  $T_j = V_{BR}$  at  $25\text{ °C} \times (1 + \alpha T \times (T_j - 25))$
2. To calculate  $V_{CL}$  versus  $T_j$ :  $V_{CL}$  at  $T_j = V_{CL}$  at  $25\text{ °C} \times (1 + \alpha T \times (T_j - 25))$
3. To calculate  $V_{CL}$  max versus  $I_{PP\text{appli}}$ :  $V_{CL\text{max}} = V_{CL} - R_D \times (I_{PP} - I_{PP\text{appli}})$  where  $I_{PP\text{appli}}$  is the surge current in the application
4. Surge capability given for both directions for unidirectional (A type) and bidirectional (CA type) devices

### 1.1 Characteristics (curves)

**Figure 3. Maximum peak power dissipation versus initial junction temperature**

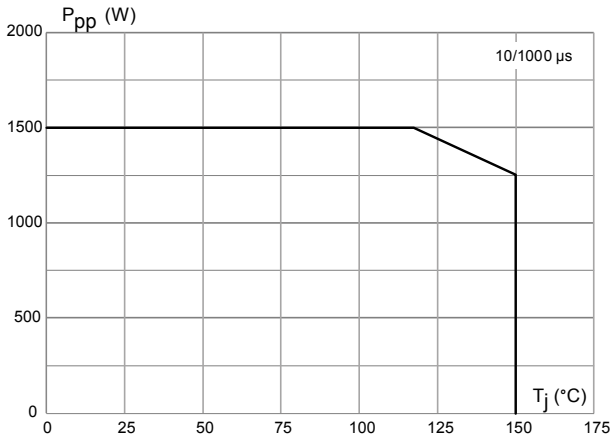

**Figure 4. Maximum peak pulse power versus exponential pulse duration**

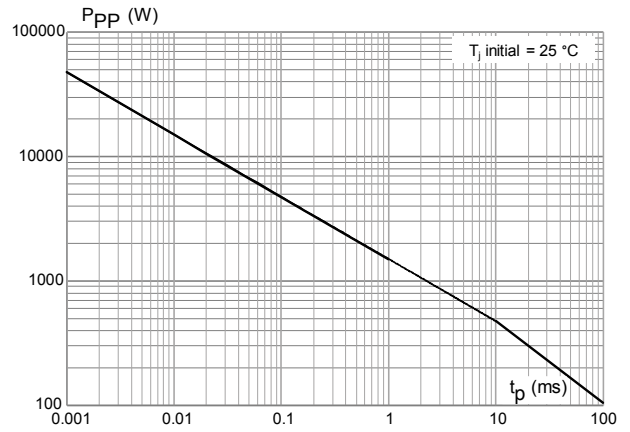

**Figure 5. Maximum peak pulse current versus clamping voltage**

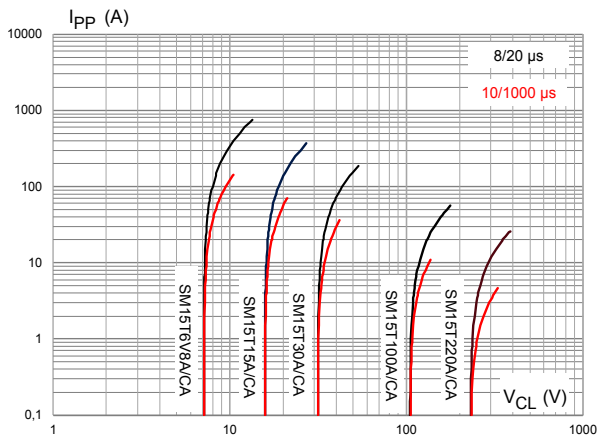

**Figure 6. Dynamic resistance versus pulse duration**

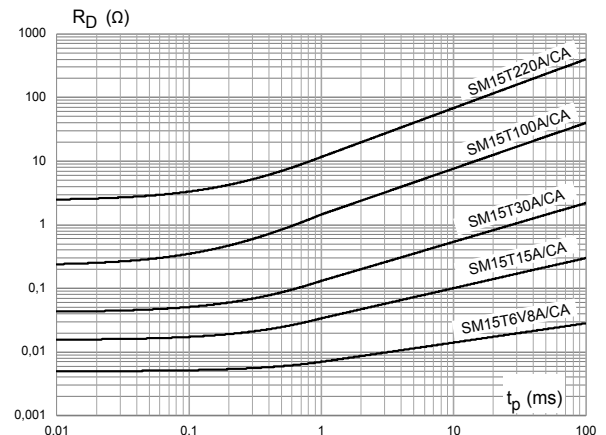

**Figure 7. Junction capacitance versus reverse applied voltage (unidirectional type)**

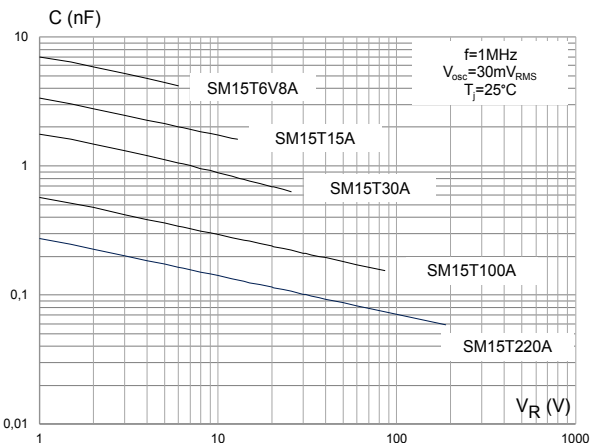

**Figure 8. Junction capacitance versus applied voltage (bidirectional type)**

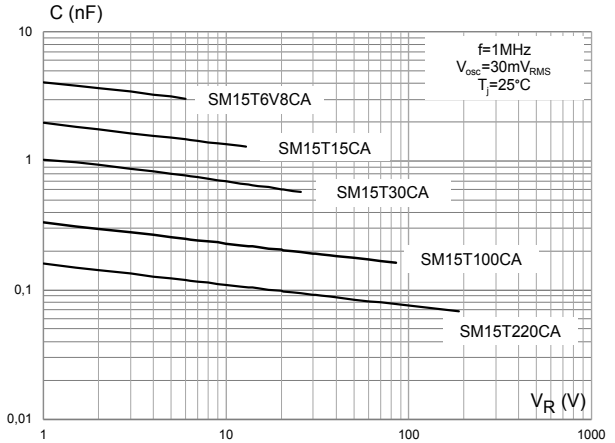

Figure 9. Leakage current versus junction temperature

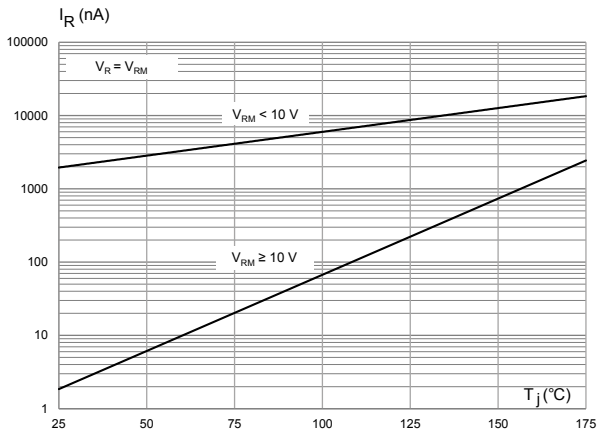

Figure 10. Peak forward voltage drop versus peak forward current

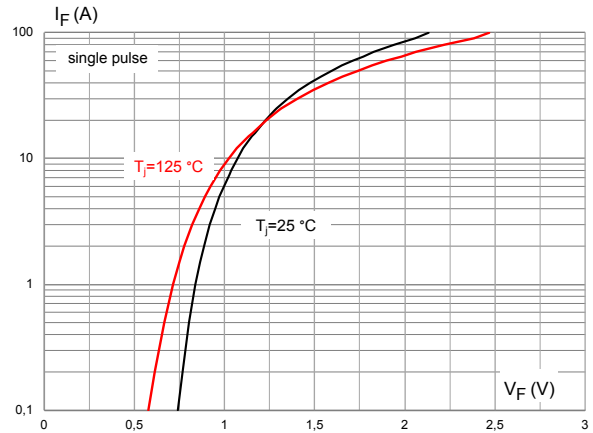

Figure 11. Thermal impedance junction to ambient versus pulse duration

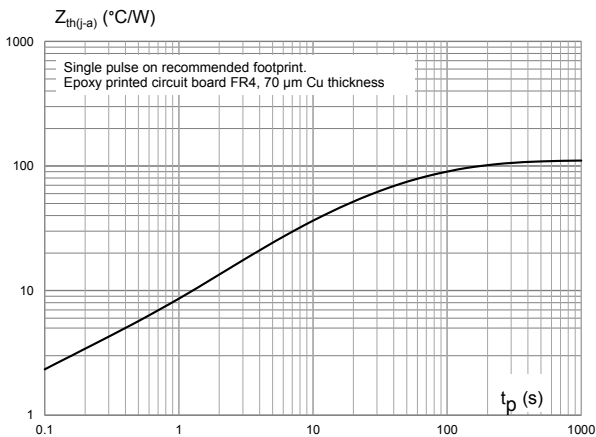
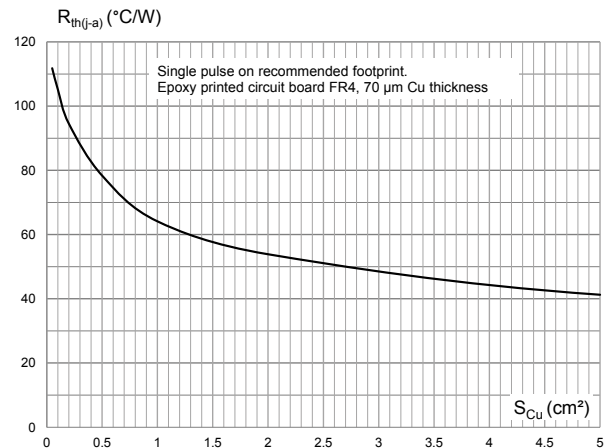

Figure 12. Thermal resistance junction to ambient versus copper area under each lead



## 2 Package information

In order to meet environmental requirements, ST offers these devices in different grades of **ECOPACK** packages, depending on their level of environmental compliance. ECOPACK specifications, grade definitions and product status are available at: [www.st.com](http://www.st.com). ECOPACK is an ST trademark.

### 2.1 SMC package information

Figure 13. SMC package outline

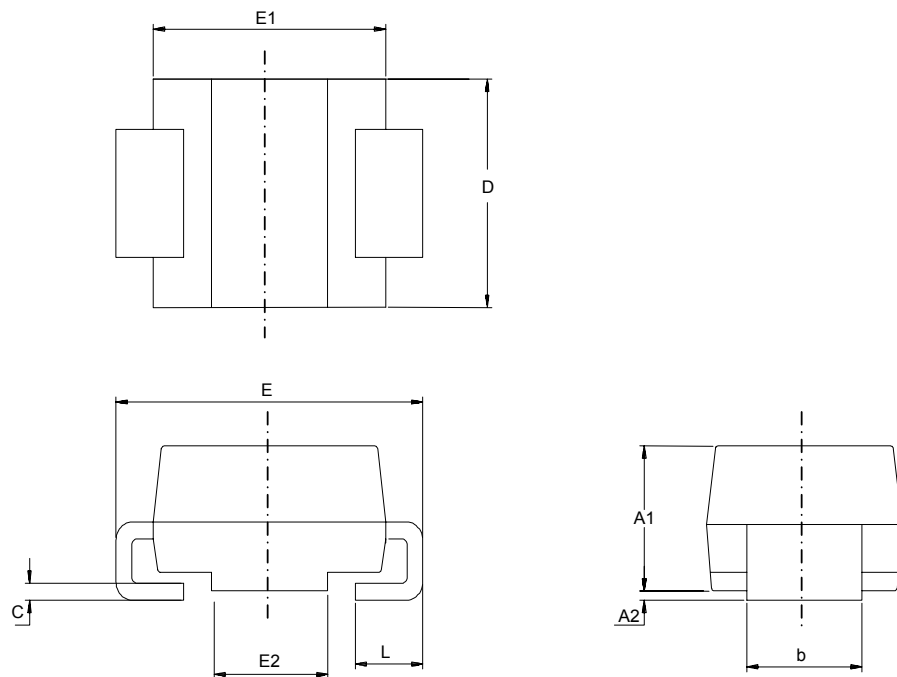

Table 3. SMC package mechanical data

| Ref. | Dimensions  |      |                             |       |
|------|-------------|------|-----------------------------|-------|
|      | Millimeters |      | Inches (for reference only) |       |
|      | Min.        | Max. | Min.                        | Max.  |
| A1   | 1.90        | 2.45 | 0.075                       | 0.096 |
| A2   | 0.05        | 0.20 | 0.002                       | 0.008 |
| b    | 2.90        | 3.20 | 0.114                       | 0.126 |
| c    | 0.15        | 0.40 | 0.006                       | 0.016 |
| D    | 5.55        | 6.25 | 0.218                       | 0.246 |
| E    | 7.75        | 8.15 | 0.305                       | 0.321 |
| E1   | 6.60        | 7.15 | 0.260                       | 0.281 |
| E2   | 4.40        | 4.70 | 0.173                       | 0.185 |
| L    | 0.75        | 1.50 | 0.030                       | 0.060 |

Figure 14. Footprint recommendation

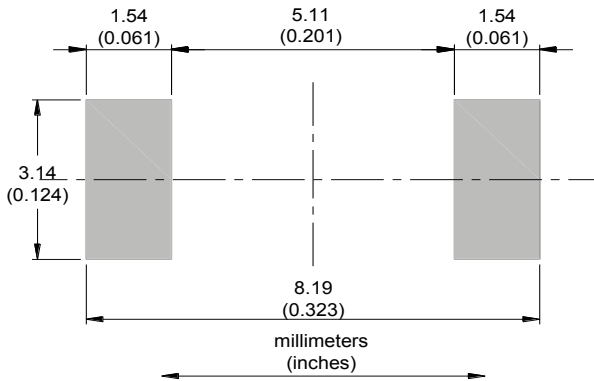

Figure 15. Marking layout

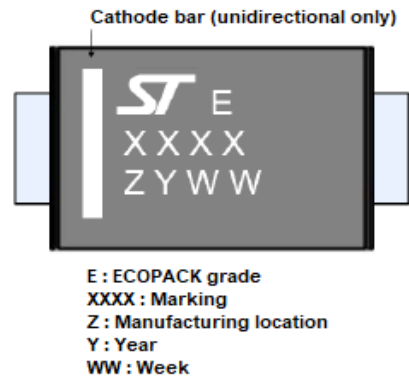
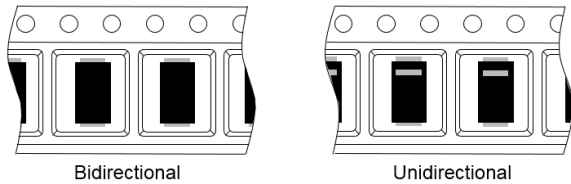

Figure 16. Package orientation in reel



Taped according to EIA-481  
Pocket dimensions are not on scale.  
Pocket shape may vary depending on package  
On bidirectional devices, marking and logo may not be always in the same direction.

Figure 17. Tape and reel orientation

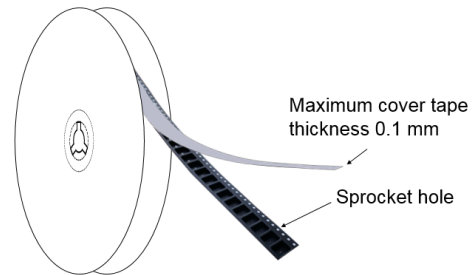

Figure 18. 13" reel dimension values (mm)

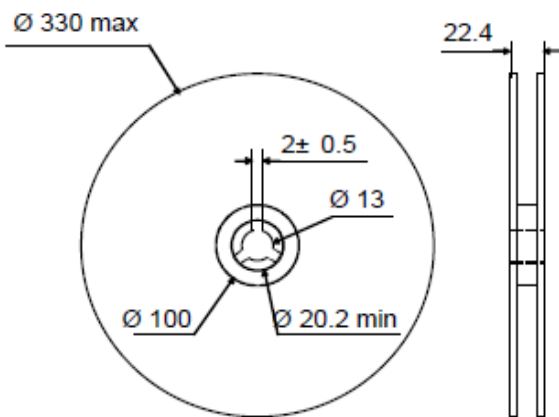

Figure 19. Inner box dimension values (mm)

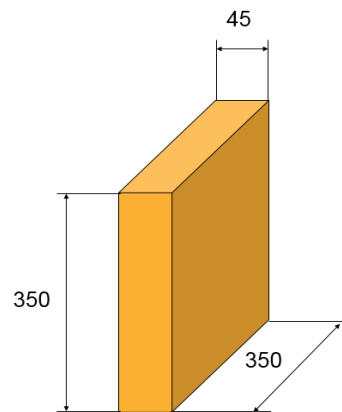
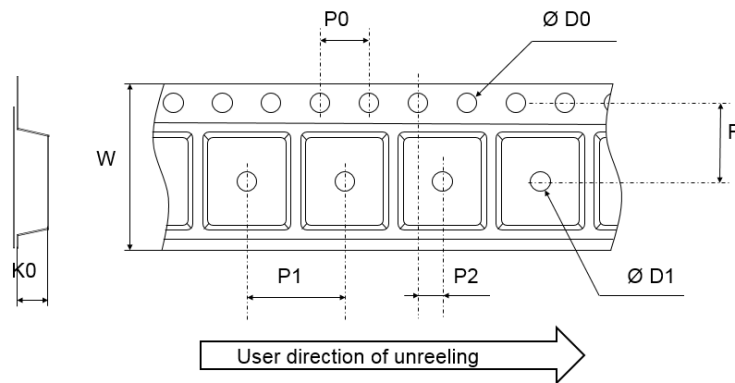

Figure 20. Tape outline



Note: Pocket dimensions are not on scale  
Pocket shape may vary depending on package

Table 4. Tape dimension values

| Ref. | Dimensions  |      |      |
|------|-------------|------|------|
|      | Millimeters |      |      |
|      | Min.        | Typ. | Max. |
| D0   | 1.4         | 1.5  | 1.6  |
| D1   | 1.5         |      |      |
| F    | 7.4         | 7.5  | 7.6  |
| K0   | 2.39        | 2.49 | 2.59 |
| P0   | 3.9         | 4.0  | 4.1  |
| P1   | 7.9         | 8.0  | 8.1  |
| P2   | 1.9         | 2.0  | 2.1  |
| W    | 15.7        | 16   | 16.3 |



## 2.2 Reflow profile

Figure 21. ST ECOPACK recommended soldering reflow profile for PCB mounting

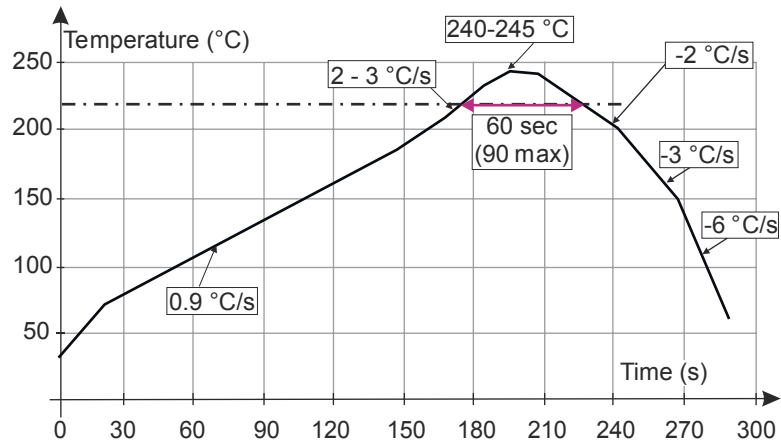

**Note:** Minimize air convection currents in the reflow oven to avoid component movement. Maximum soldering profile corresponds to the latest IPC/JEDEC J-STD-020.

### 3 Ordering information

**Table 5. Ordering information**

| Order code                    | Marking              | Package | Weight | Base qty. | Delivery mode |
|-------------------------------|----------------------|---------|--------|-----------|---------------|
| SM15TxxA/CA-TR <sup>(1)</sup> | See Table 6. Marking | SMC     | 0.25 g | 2500      | Tape and reel |

1. Where xxx is nominal value of  $V_{BR}$  and A or CA indicates unidirectional or bidirectional version.

**Table 6. Marking**

| Order code | Marking | Order code | Marking |
|------------|---------|------------|---------|
| SM15T6V8A  | MDE     | SM15T6V8CA | BDE     |
| SM15T7V5A  | MDG     | SM15T7V5CA | BDG     |
| SM15T10A   | MDP     | SM15T10CA  | BDP     |
| SM15T12A   | MDT     | SM15T12CA  | BDT     |
| SM15T15A   | MDX     | SM15T15CA  | BDX     |
| SM15T18A   | MEE     | SM15T18CA  | BEE     |
| SM15T22A   | MEK     | SM15T22CA  | BEK     |
| SM15T24A   | MEM     | SM15T24CA  | BEM     |
| SM15T27A   | MEP     | SM15T27CA  | BEP     |
| SM15T30A   | MER     | SM15T30CA  | BER     |
| SM15T33A   | MET     | SM15T33CA  | BET     |
| SM15T36A   | MEV     | SM15T36CA  | BEV     |
| SM15T39A   | MEX     | SM15T39CA  | BEX     |
| SM15T68A   | MFP     | SM15T68CA  | BFP     |
| SM15T75A   | MFO     | SM15T75CA  | BFO     |
| SM15T100A  | MFX     | SM15T100CA | BFX     |
| SM15T150A  | MGK     | SM15T150CA | BGK     |
| SM15T200A  | MGV     | SM15T200CA | BGV     |
| SM15T220A  | MGX     | SM15T220CA | BGX     |

## Revision history

**Table 7. Document revision history**

| Date           | Version | Changes   |
|----------------|---------|---|
| September-2001 | 3B      | Last issue  |
| 19-Feb-2007    | 4       | Peak pulse power Figure 4 on page 4 updated.  |
| 04-Feb-2009    | 5       | Updated ECOPACK statement. Added RD columns in Table 3. Updated characteristic curves, Figure 3 to Figure 11.         |
| 17-Sep-2009    | 6       | Document updated for low leakage current.   |
| 24-Apr-2020    | 7       | Removed figure 12. Minor text changes to improve the readability of the document.                                     |
| 16-May-2022    | 8       | Updated <a href="#">Figure 6</a> , <a href="#">Figure 7</a> , <a href="#">Figure 8</a> and <a href="#">Figure 9</a> . |

**IMPORTANT NOTICE – READ CAREFULLY**

STMicroelectronics NV and its subsidiaries (“ST”) reserve the right to make changes, corrections, enhancements, modifications, and improvements to ST products and/or to this document at any time without notice. Purchasers should obtain the latest relevant information on ST products before placing orders. ST products are sold pursuant to ST’s terms and conditions of sale in place at the time of order acknowledgment.

Purchasers are solely responsible for the choice, selection, and use of ST products and ST assumes no liability for application assistance or the design of purchasers’ products.

No license, express or implied, to any intellectual property right is granted by ST herein.

Resale of ST products with provisions different from the information set forth herein shall void any warranty granted by ST for such product.

ST and the ST logo are trademarks of ST. For additional information about ST trademarks, refer to [www.st.com/trademarks](http://www.st.com/trademarks). All other product or service names are the property of their respective owners.

Information in this document supersedes and replaces information previously supplied in any prior versions of this document.

© 2022 STMicroelectronics – All rights reserved

单击下面可查看定价，库存，交付和生命周期等信息

[>>STMicro\(意法半导体\)](#)