

0.8 A - 600 V overvoltage protected AC switch (ACS™)

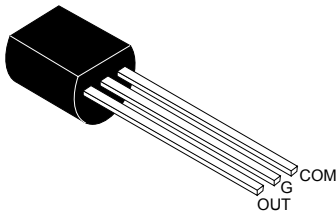

TO-92

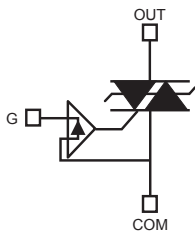

COM Common drive reference to connect to the mains
 OUT Output to connect to the load.
 G Gate input to connect to the controller through gate resistor

Features

- Enables equipment to meet IEC 61000-4-5 surge with overvoltage crowbar technology
- High noise immunity against static dV/dt and IEC 61000-4-4 burst
- Needs no external protection snubber or varistor
- Reduces component count by up to 80% and Interfaces directly with the micro-controller
- Common package tab connection supports connection of several alternating current switches on the same cooling pad
- V_{CL} gives headroom before clamping then crowbar action

Applications

- Alternating current on/off static switching in appliances and industrial control systems
- Driving low power high inductive or resistive loads like:
 - relay, valve, solenoid, dispenser
 - pump, fan, low power motor, door lock, air flow dumper
 - lamp

Description

The ACS108-6SA belongs to the AC switch range (built with A. S. D.® technology). This high performance switch can control a load of up to 0.8 A.

This device switch includes an overvoltage crowbar structure to absorb the inductive turn-off energy, and a gate level shifter driver to separate the digital controller from the main switch. It is triggered with a negative gate current flowing out of the gate pin.

Note: ®: A.S.D. is a registered trademark of STMicroelectronics

Note: TM: ACS is a trademark of STMicroelectronics

Product status link

[ACS108-6SA](#)

Product summary

$I_{T(RMS)}$	0.8 A
V_{DRM}, V_{RRM}	600 V
I_{GT}	10 mA

1 Characteristics

Table 1. Absolute maximum ratings ($T_{amb} = 25\text{ °C}$, unless otherwise specified)

Symbol	Parameter	Value	Unit	
$I_{T(RMS)}$	On-state rms current (full sine wave), $S = 5\text{ cm}^2$	$T_{amb} = 64\text{ °C}$	0.45	A
		$T_{lead} = 76\text{ °C}$	0.8	
I_{TSM}	Non repetitive surge peak on-state current T_j initial = 25 °C , (full cycle sine wave)	$t_p = 20\text{ ms}$	13	A
		$t_p = 16.7\text{ ms}$	13.7	
I^2t	I^2t for fuse selection	$t_p = 10\text{ ms}$	1.1	A^2s
di/dt	Critical rate of rise on-state current $I_G = 2 \times I_{GT}$, $tr \leq 100\text{ ns}$	$f = 120\text{ Hz}$, $T_j = 125\text{ °C}$	100	$\text{A}/\mu\text{s}$
$V_{PP}^{(1)}$	Non repetitive line peak pulse voltage		2	kV
$P_{G(AV)}$	Average gate power dissipation	$T_j = 125\text{ °C}$	0.1	W
V_{GM}	Peak positive gate voltage	$T_j = 125\text{ °C}$	10	V
I_{GM}	Peak gate current ($t_p = 20\text{ }\mu\text{s}$)	$T_j = 125\text{ °C}$	1	A
T_{stg}	Storage temperature range		-40 to +150	$^{\circ}\text{C}$
T_j	Operating junction temperature range		-30 to +125	$^{\circ}\text{C}$

1. according to test described by standard IEC 61000-4-5, see Figure 15. Overvoltage ruggedness test circuit for resistive and inductive loads, $T_{amb} = 25\text{ °C}$ (conditions equivalent to IEC 61000-4-5 standard) for conditions

Table 2. Electrical characteristics ($T_j = 25\text{ °C}$, unless otherwise specified)

Symbol	Test conditions	Quadrant	Value	Unit	
$I_{GT}^{(1)}$	$V_{OUT} = 12\text{ V}$, $R_L = 33\text{ }\Omega$	II - III	Max.	10	mA
V_{GT}			Max.	1.0	V
V_{GD}	$V_{OUT} = V_{DRM}$, $R_L = 3.3\text{ k}\Omega$, $T_j = 125\text{ °C}$	II - III	Min.	0.15	V
I_H	$I_{OUT} = 100\text{ mA}$		Max.	10	mA
I_L	$I_G = 1.2 \times I_{GT}$		Max.	25	mA
dV/dt	$V_{OUT} = 402\text{ V}$, gate open, $T_j = 125\text{ °C}$		Min.	2000	$\text{V}/\mu\text{s}$
$(di/dt)_c$	Without snubber ($15\text{ V}/\mu\text{s}$), $T_j = 125\text{ °C}$, turn-off time $\leq 20\text{ ms}$		Min.	2	A/ms
V_{CL}	$I_{CL} = 0.1\text{ mA}$, $t_p = 1\text{ ms}$		Min.	650	V

1. Minimum I_{GT} is guaranteed at 10% of I_{GT} max.

Table 3. Static electrical characteristics

Symbol	Test conditions	Value	Unit
$V_{TM}^{(1)}$	$I_{TM} = 1.1\text{ A}$, $t_p = 500\text{ }\mu\text{s}$	$T_j = 25\text{ °C}$	Max. 1.3 V
$V_{T0}^{(1)}$	Threshold voltage	$T_j = 125\text{ °C}$	Max. 0.85 V
$R_d^{(1)}$	Dynamic resistance	$T_j = 125\text{ °C}$	Max. 300 m Ω
I_{DRM} I_{RRM}	$V_{OUT} = V_{DRM}/V_{RRM}$	$T_j = 25\text{ °C}$	Max. 2 μA
		$T_j = 125\text{ °C}$	0.2 mA

1. For both polarities of OUT pin referenced to COM pin

Table 4. Thermal characteristics

Symbol	Parameter	Max. value	Unit
$R_{th(j-l)}$	Junction to lead (AC)	60	°C/W
$R_{th(j-a)}$	Junction to ambient	150	

1.1 Characteristics (curves)

Figure 1. Maximum power dissipation versus rms on-state current

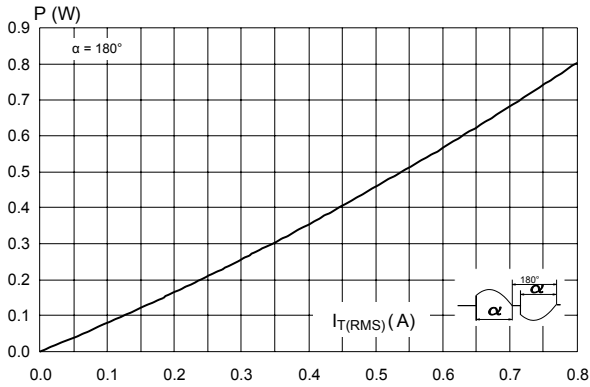

Figure 2. On-state rms current versus ambient temperature

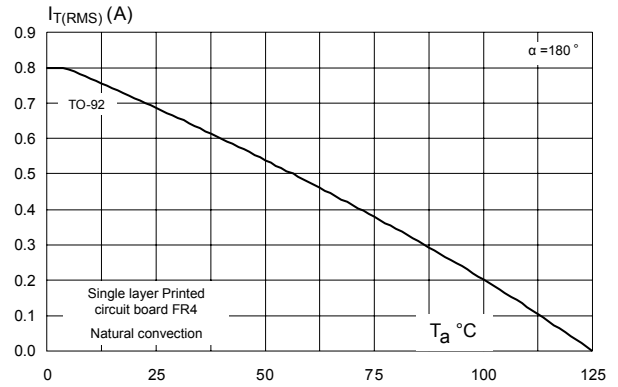

Figure 3. Relative variation of thermal impedance junction to ambient versus pulse duration

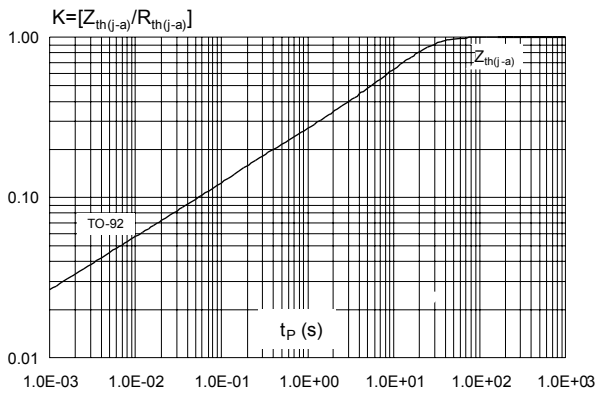

Figure 4. Relative variation of holding and latching current versus junction temperature

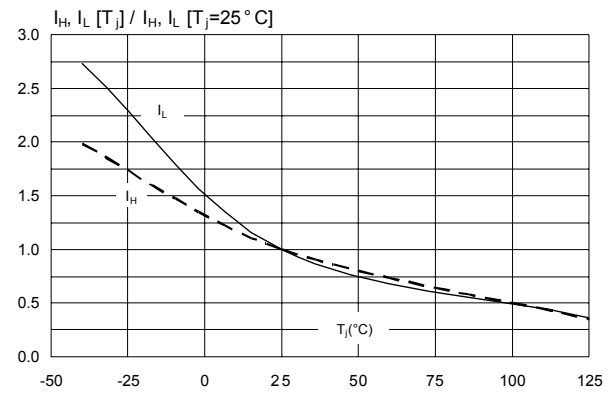

Figure 5. Relative variation of I_{GT} and V_{GT} versus junction temperature

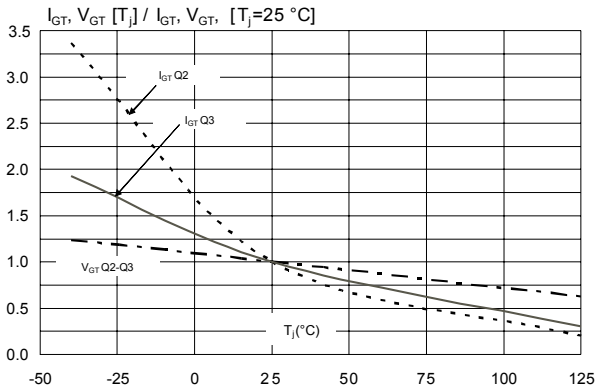

Figure 6. Surge peak on-state current versus number of cycles

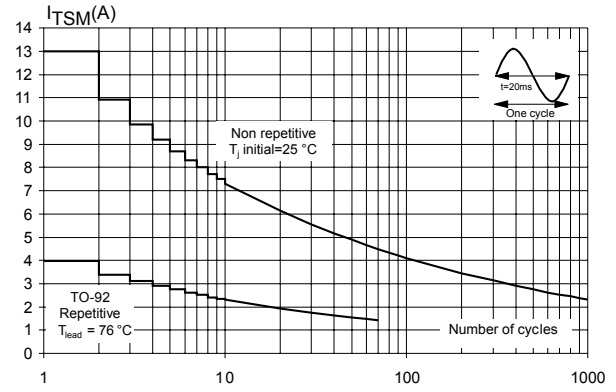

Figure 7. Non repetitive surge peak on-state current for a sinusoidal pulse

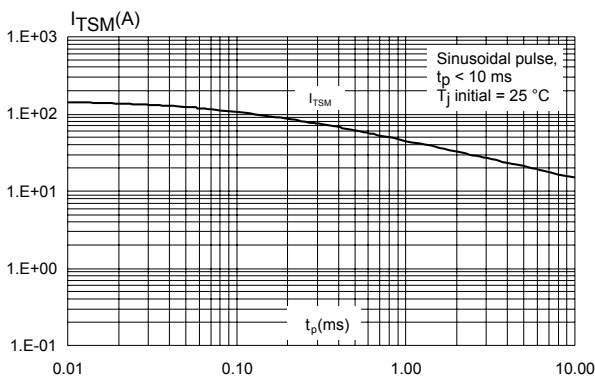

Figure 8. On-state characteristics (maximum values)

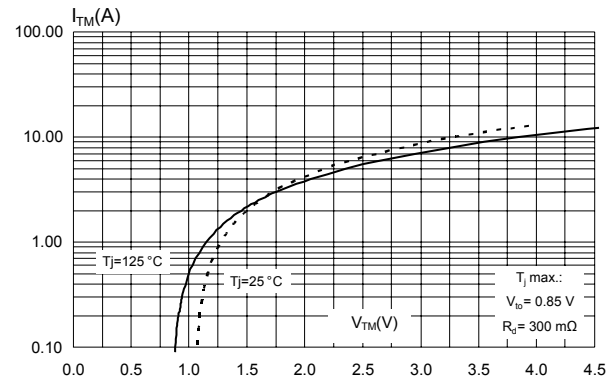

Figure 9. Relative variation of critical rate of decrease of main current versus junction temperature

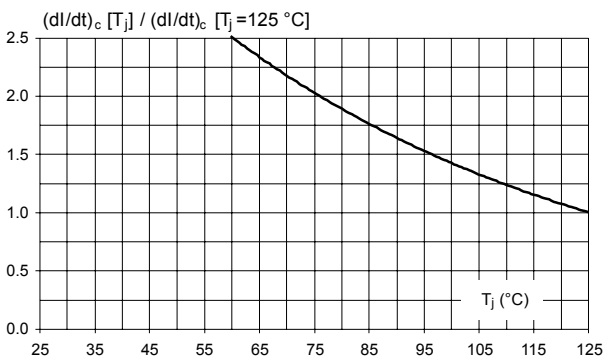

Figure 10. Relative variation of static dV/dt immunity versus junction temperature (typical values above 5kV/μs)

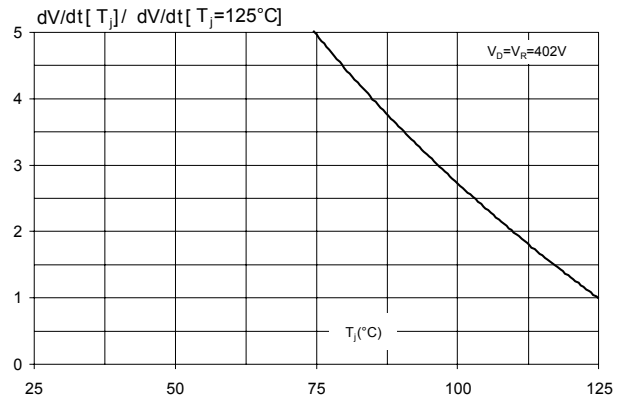

Figure 11. Relative variation of leakage current versus junction temperature

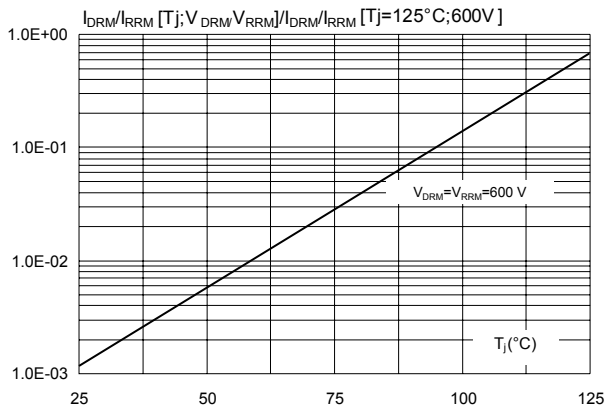
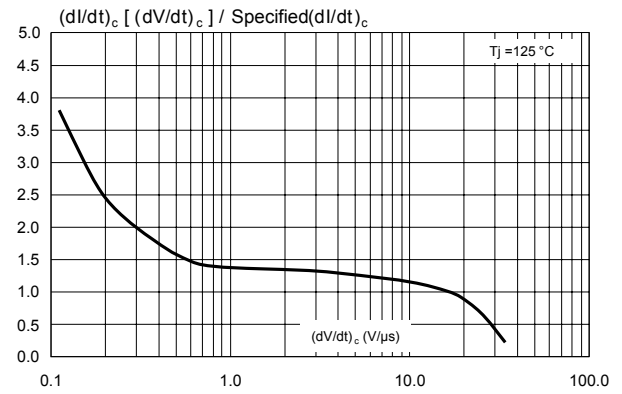

Figure 12. Relative variation of critical rate of decrease of main current $(di/dt)_c$ versus $(dV/dt)_c$



2 Alternating current mains switch - basic application

The ACS108 switch is triggered by a negative gate current flowing from the gate pin G. The switch can be driven directly by the digital controller through a resistor as shown in [Figure 13. Typical application schematic](#)

Thanks to its overvoltage protection and turn-off commutation performance, the ACS108 switch can drive a small power high inductive load with neither varistor nor additional turn-off snubber.

Figure 13. Typical application schematic

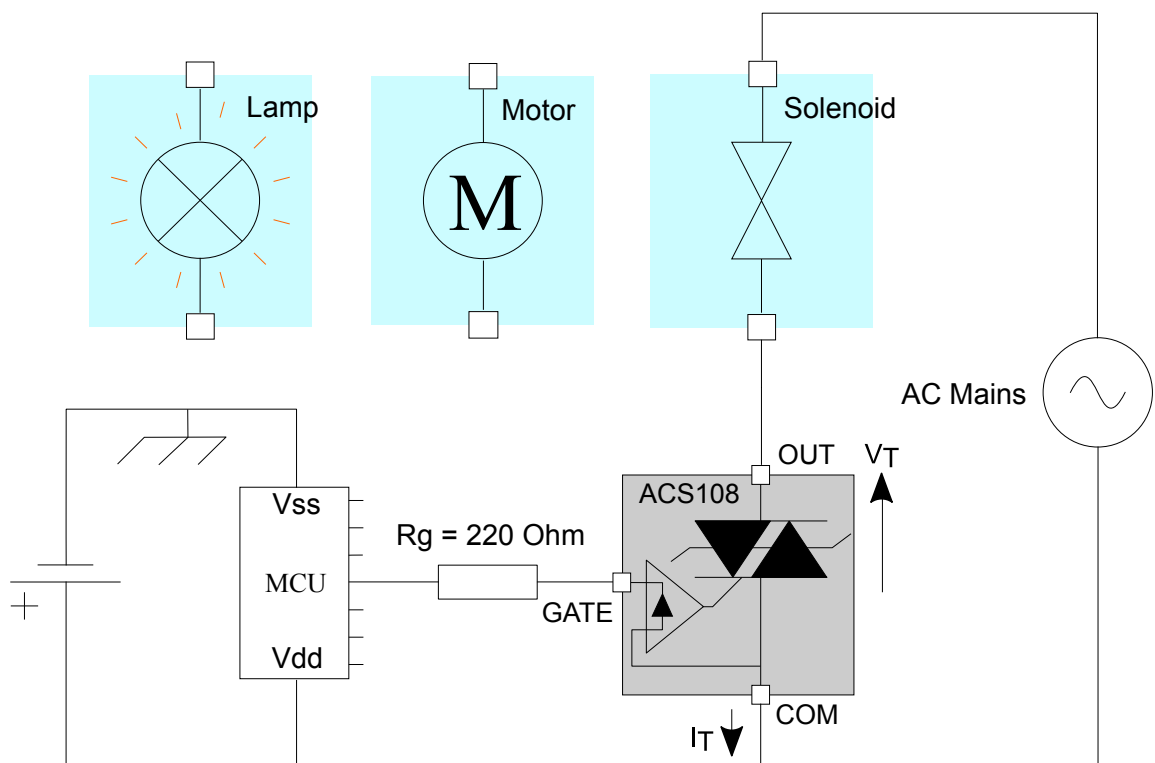

2.1 Protection against overvoltage: the best choice is ACS

In comparison with standard Triacs the ACS108 is over-voltage self-protected, as specified by the parameter V_{CL} . This feature is useful in two operating conditions: in case of turn-off of very inductive load, and in case of surge voltage that can occur on the electrical network.

2.1.1 High inductive load switch-off: turn-off overvoltage clamping

With high inductive and low rms current loads the rate of decrease of the current is very low. An overvoltage can occur when the gate current is removed and the OUT current is lower than I_H .

As shown in [Figure 14. Switching off of a high inductive load - typical clamping capability of ACS108 \(\$T_{amb} = 25^\circ\text{C}\$ \)](#), at the end of the last conduction half-cycle, the load current decreases ①. The load current reaches the holding current level I_H ②, and the ACS turns off ③. The water valve, as an inductive load (up to 15 H), reacts as a current generator and an overvoltage is created, which is clamped by the ACS ④. The current flows through the ACS avalanche and decreases linearly to zero. During this time, the voltage across the switch is limited to the

clamping voltage V_{CL} . The energy stored in the inductance of the load is dissipated in the clamping section that is designed for this purpose. When the energy has been dissipated, the ACS voltage falls back to the mains voltage value (230 V rms, 50 Hz) ⑤.

Figure 14. Switching off of a high inductive load - typical clamping capability of ACS108 ($T_{amb} = 25\text{ }^{\circ}\text{C}$)

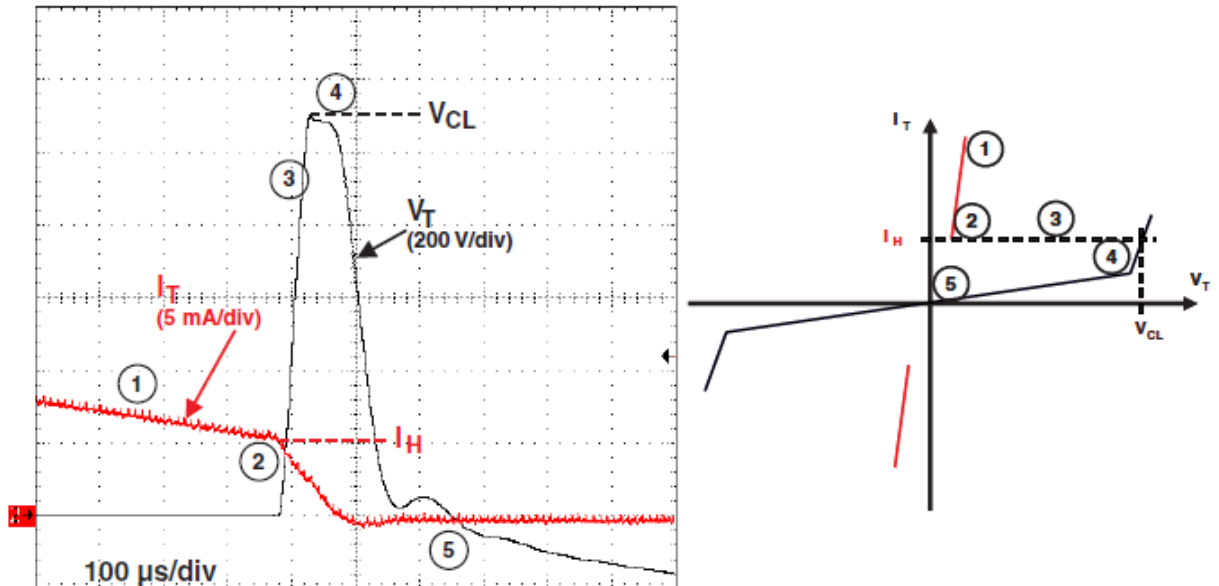

2.1.2

Alternating current mains transient voltage ruggedness

The ACS108 switch is able to withstand safely the AC mains transients either by clamping the low energy spikes or by breaking-over when subjected to high energy shocks, even with high turn-on current rises.

The test circuit shown in Figure 15. **Overvoltage ruggedness test circuit for resistive and inductive loads, $T_{amb} = 25\text{ }^{\circ}\text{C}$ (conditions equivalent to IEC 61000-4-5 standard)** is representative of the final ACS108 application, and is also used to test the AC switch according to the IEC 61000-4-5 standard conditions. Thanks to the load limiting the current, the ACS108 switch withstands the voltage spikes up to 2 kV above the peak mains voltage. The protection is based on an overvoltage crowbar technology. Actually, the ACS108 breaks over safely as shown in Figure 16. **Typical current and voltage waveforms across the ACS108 (+2 kV surge, IEC 61000-4-5 standard)**. The ACS108 recovers its blocking voltage capability after the surge (switch off back at the next zero crossing of the current).

Such non-repetitive tests can be done 10 times on each AC mains voltage polarity.

Figure 15. Overvoltage ruggedness test circuit for resistive and inductive loads, $T_{amb} = 25\text{ }^{\circ}\text{C}$ (conditions equivalent to IEC 61000-4-5 standard)

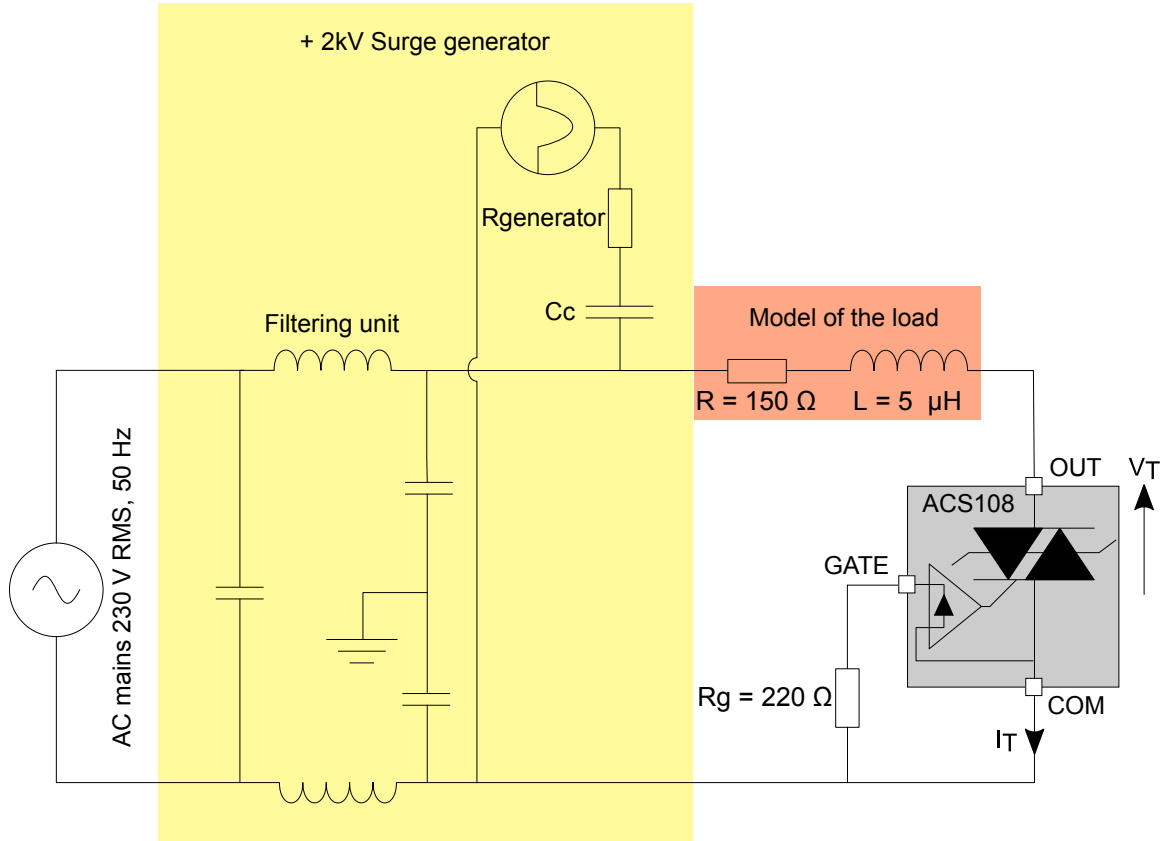
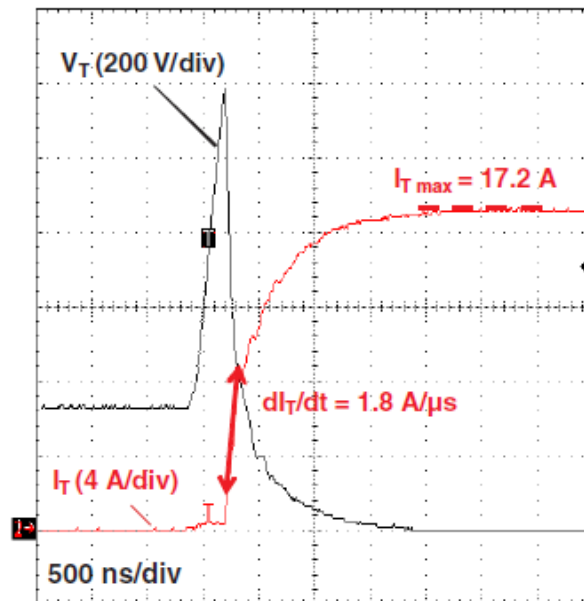

Figure 16. Typical current and voltage waveforms across the ACS108 (+2 kV surge, IEC 61000-4-5 standard)



3 Package information

In order to meet environmental requirements, ST offers these devices in different grades of ECOPACK® packages, depending on their level of environmental compliance. ECOPACK® specifications, grade definitions and product status are available at: www.st.com. ECOPACK® is an ST trademark.

3.1 TO-92 package information

- Epoxy meets UL94, V0
- Lead free plating + halogen-free molding resin

Figure 17. TO-92 package outline

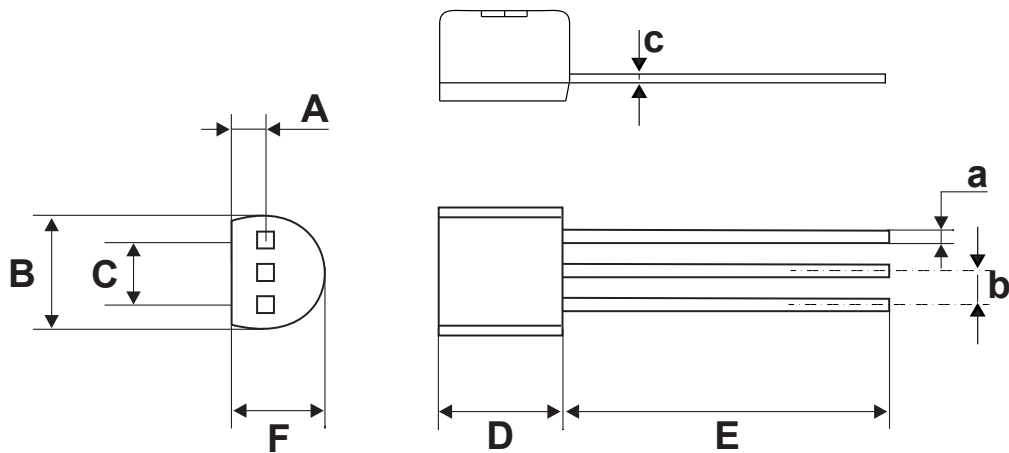

Table 5. TO-92 package mechanical data

Ref.	Dimensions					
	Millimeters			Inches ⁽¹⁾		
	Min.	Typ.	Max.	Min.	Typ.	Max.
A		1.35			0.0531	
B			4.70			0.1850
C		2.54			0.1000	
D	4.40			0.1732		
E	12.70			0.5000		
F			3.70			0.1457
a			0.50			0.0197
b		1.27			0.500	
c			0.48			0.0189

1. Inches dimensions given for information

4 Ordering information

Figure 18. Ordering information scheme

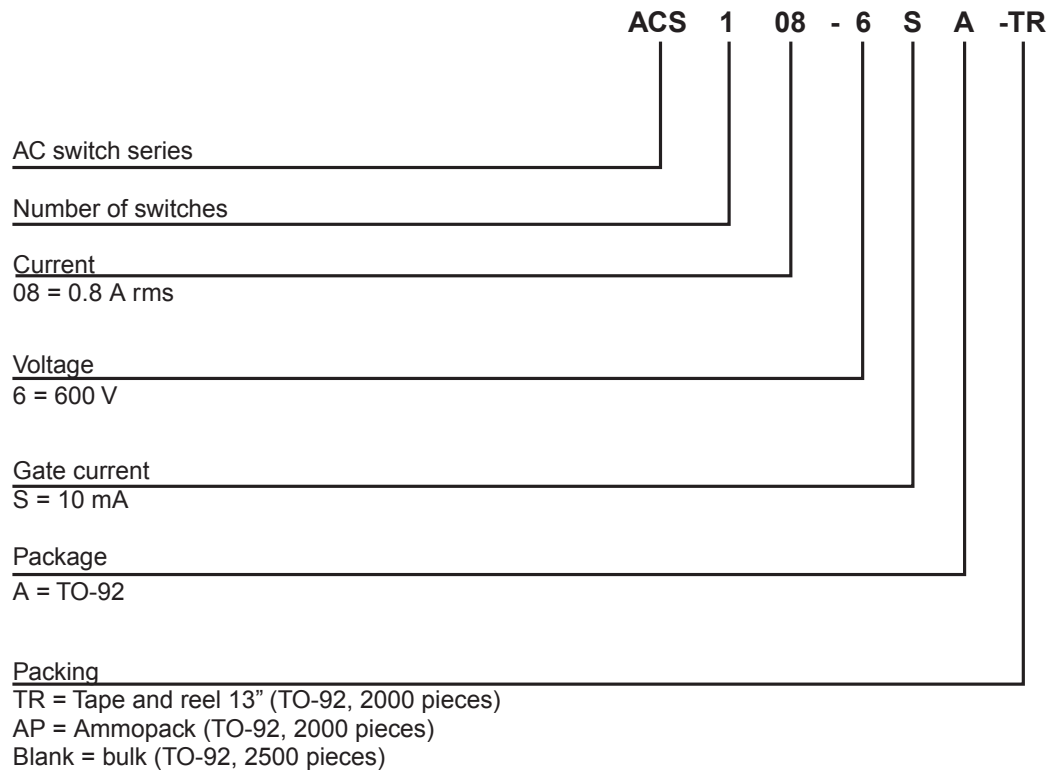

Table 6. Ordering information

Order code	Marking	Package	Weight	Base qty.	Packing mode
ACS108-6SA	ACS108 6SA ⁽¹⁾	TO-92	0.2 g	2500	Bulk
ACS108-6SA-TR				2000	Tape and reel
ACS108-6SA-AP				2000	Ammopack

1. First row = ACS108, second row = 6SA

Revision history

Table 7. Document revision history

Date	Version	Changes
Apr_2004	1	Initial release. This datasheet covers order codes previously described in the datasheet for ACS108-6S, Doc ID 11962, Rev 3 December 2010.
21-Jun-2005	2	Marking information updated from ACSxxxx to ACS1xxx.
11-Jul-2012	3	Removed 500 V devices and added 600 V and 800 V devices.
27-Sep-2013	4	Corrected typographical error in Figure 4.
31-Oct-2013	5	Corrected character formatting issues in Section 2.1.1.
07-Feb-2019	6	Removed SOT-223 package and ACS108-8SA.

IMPORTANT NOTICE – PLEASE READ CAREFULLY

STMicroelectronics NV and its subsidiaries (“ST”) reserve the right to make changes, corrections, enhancements, modifications, and improvements to ST products and/or to this document at any time without notice. Purchasers should obtain the latest relevant information on ST products before placing orders. ST products are sold pursuant to ST’s terms and conditions of sale in place at the time of order acknowledgement.

Purchasers are solely responsible for the choice, selection, and use of ST products and ST assumes no liability for application assistance or the design of Purchasers’ products.

No license, express or implied, to any intellectual property right is granted by ST herein.

Resale of ST products with provisions different from the information set forth herein shall void any warranty granted by ST for such product.

ST and the ST logo are trademarks of ST. All other product or service names are the property of their respective owners.

Information in this document supersedes and replaces information previously supplied in any prior versions of this document.

© 2019 STMicroelectronics – All rights reserved

单击下面可查看定价，库存，交付和生命周期等信息

[>>STMicro\(意法半导体\)](#)