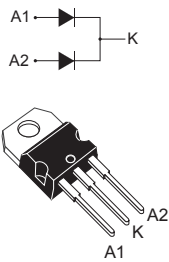

120 V power Schottky rectifier

TO-220AB

Features

- High current capability
- Avalanche rated
- Low forward voltage drop current
- High frequency operation
- ECOPACK[®]2 compliant

Applications

- Switching diode
- SMPS
- DC/DC converter
- LED lighting
- Notebook adapter

Description

This Schottky rectifier is suited for high frequency switch mode power supply.

The voltage drop versus leakage current trade-off is in keeping with medium power hi-density adapter design.

Packed in TO-220AB, the **STPS40M120C** is optimized for use in notebook, game station and desktop adaptors, providing in these applications a good efficiency at both low and high load.

Product status link

[STPS40M120C](#)

Product summary

Symbol	Value
$I_{F(AV)}$	2 x 20 A
V_{RRM}	120 V
T_j (max.)	150 °C
V_F (typ.)	0.61 V

1 Characteristics

Table 1. Absolute Ratings (limiting values, per diode, at 25 °C, unless otherwise specified)

Symbol	Parameter		Value	Unit	
V _{RRM}	Repetitive peak reverse voltage		120	V	
I _{F(RMS)}	Forward rms current		30	A	
I _{F(AV)}	Average forward current, $\delta = 0.5$	T _C = 130 °C	Per diode	20	A
		T _C = 120 °C	Per device	40	
I _{FSM}	Surge non repetitive forward current	t _p = 10 ms sinusoidal		220	A
P _{ARM}	Repetitive peak avalanche power	t _p = 10 μ s, T _j = 125 °C		1600	W
T _{stg}	Storage temperature range		-65 to +175	°C	
T _j	Maximum operating junction temperature ⁽¹⁾		150	°C	

1. $(dP_{tot}/dT_j) < (1/R_{th(j-a)})$ condition to avoid thermal runaway for a diode on its own heatsink.

Table 2. Thermal resistance parameters

Symbol	Parameter		Value	Unit
R _{th(j-c)}	Junction to case	Per diode	1.10	°C/W
		Total	0.80	
R _{th(c)}	Coupling		0.50	

When the diodes 1 and 2 are used simultaneously:

$$\Delta T_j(\text{diode1}) = P_{(\text{diode1})} \times R_{th(j-c)} (\text{per diode}) + P_{(\text{diode2})} \times R_{th(c)}$$

For more information, please refer to the following application note :

- AN5088 : Rectifiers thermal management, handling and mounting recommendations

Table 3. Static electrical characteristics (per diode)

Symbol	Parameter	Test conditions		Min.	Typ.	Max.	Unit
I _R ⁽¹⁾	Reverse leakage current	T _j = 25 °C	V _R = V _{RRM}	-	75	370	μ A
		T _j = 125 °C		-	25	70	mA
V _F ⁽²⁾	Forward voltage drop	T _j = 125 °C	I _F = 5 A	-	0.44	0.49	V
		T _j = 125 °C	I _F = 10 A	-	0.52	0.57	
		T _j = 25 °C	I _F = 20 A	-		0.79	
		T _j = 125 °C		-	0.61	0.67	

1. Pulse test: t_p = 5 ms, $\delta < 2\%$

2. Pulse test: t_p = 380 μ s, $\delta < 2\%$

To evaluate the conduction losses, use the following equation: $P = 0.54 \times I_{F(AV)} + 0.0065 \times I_F^2$ (RMS)

For more information, please refer to the following application notes related to the power losses :

- AN604: Calculation of conduction losses in a power rectifier
- AN4021: Calculation of reverse losses on a power diode

1.1 Characteristics (curves)

Figure 1. Average forward power dissipation versus average forward current (per diode)

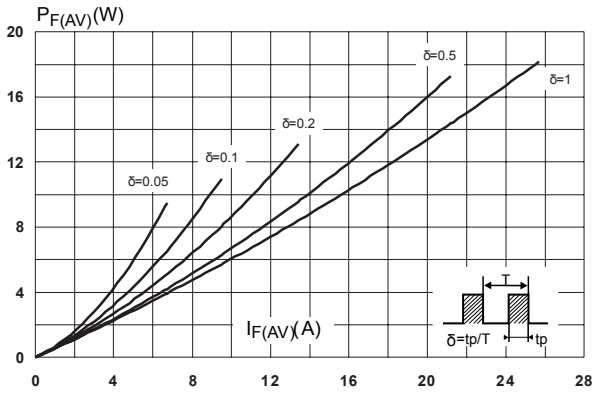

Figure 2. Average forward current versus ambient temperature ($\delta = 0.5$, per diode)

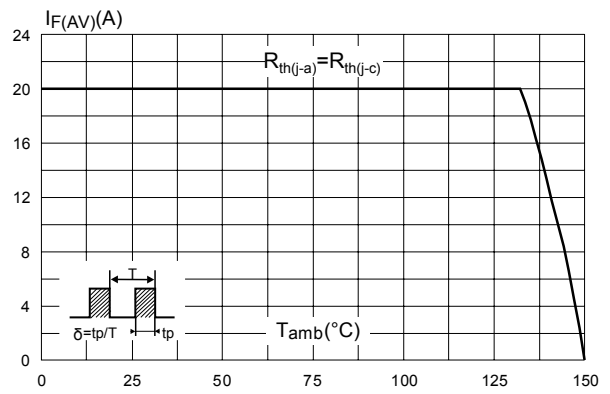

Figure 3. Normalized avalanche power derating versus pulse duration ($T_j = 125^{\circ}C$)

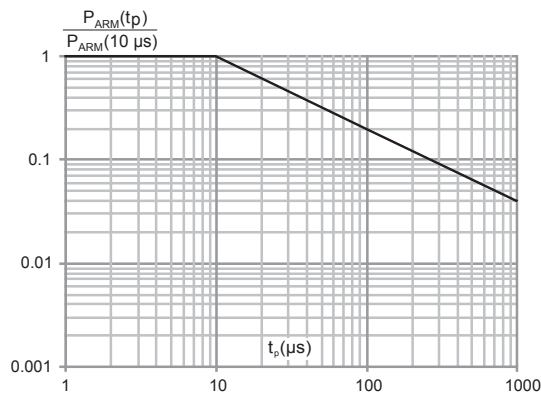

Figure 4. Relative variation of thermal impedance junction to case versus pulse duration

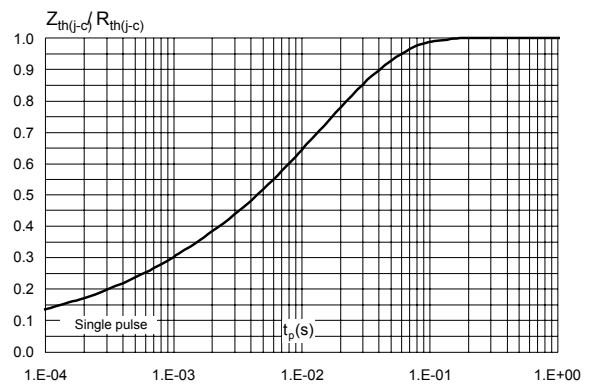

Figure 5. Reverse leakage current versus reverse voltage applied (typical values, per diode)

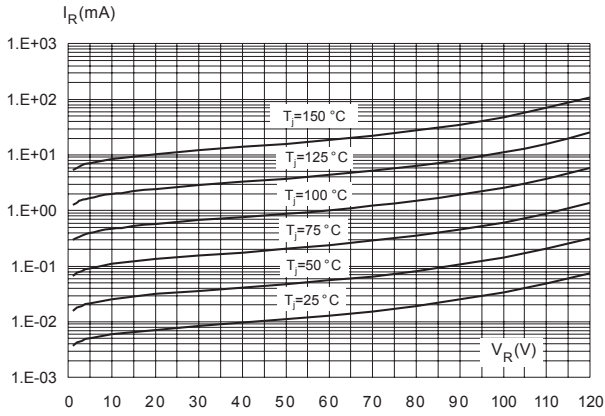

Figure 6. Junction capacitance versus reverse voltage applied (typical values, per diode)

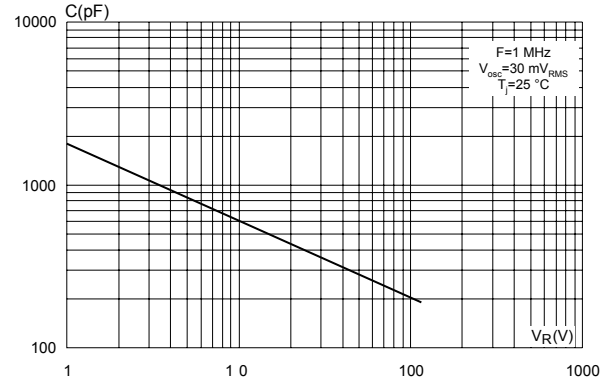
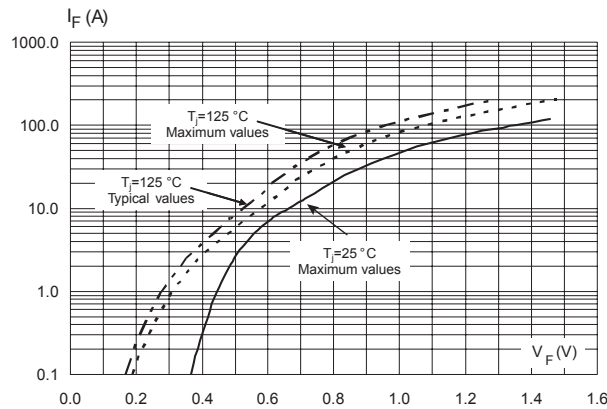

Figure 7. Forward voltage drop versus forward current (per diode)



2 Package information

In order to meet environmental requirements, ST offers these devices in different grades of ECOPACK® packages, depending on their level of environmental compliance. ECOPACK® specifications, grade definitions and product status are available at: www.st.com. ECOPACK® is an ST trademark.

2.1 TO-220AB package information

- Epoxy meets UL 94,V0
- Cooling method: by conduction (C)
- Recommended torque value: 0.55 N·m
- Maximum torque value: 0.70 N·m

Figure 8. TO-220AB package outline

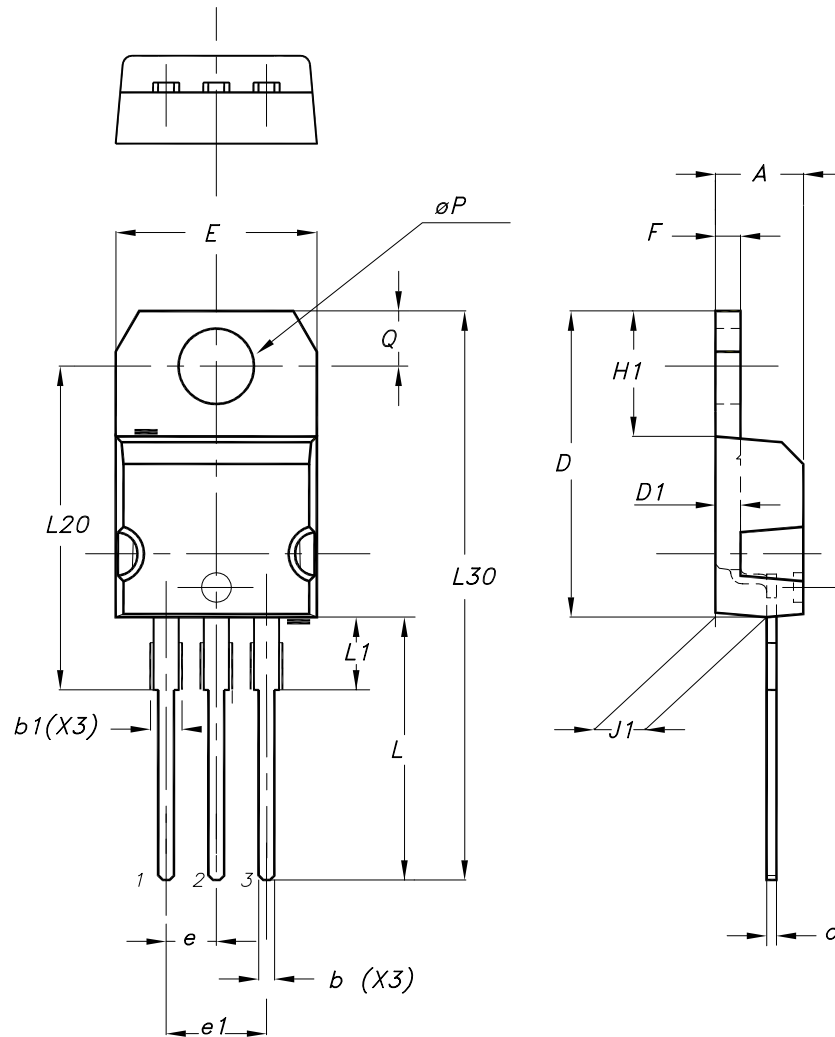

Table 4. TO-220AB package mechanical data

Ref.	Dimensions			
	Millimeters		Inches (for reference only)	
	Min.	Max.	Min.	Max.
A	4.40	4.60	0.173	0.181
b	0.61	0.88	0.240	0.035
b1	1.14	1.55	0.045	0.061
c	0.48	0.70	0.019	0.028
D	15.25	15.75	0.600	0.620
D1	1.27 typ.		0.050 typ.	
E	10.00	10.40	0.394	0.409
e	2.40	2.70	0.094	0.106
e1	4.95	5.15	0.195	0.203
F	1.23	1.32	0.048	0.052
H1	6.20	6.60	0.244	0.260
J1	2.40	2.72	0.094	0.107
L	13.00	14.00	0.512	0.551
L1	3.50	3.93	0.138	0.155
L20	16.40 typ.		0.646 typ.	
L30	28.90 typ.		1.138 typ.	
θP	3.75	3.85	0.148	0.152
Q	2.65	2.95	0.104	0.116

3 Ordering information

Table 5. Ordering information

Order code	Marking	Package	Weight	Base qty.	Delivery mode
STPS40M120CT	PS40M120CT	TO-220AB	1.95 g	50	Tube

Revision history

Table 6. Document revision history

Date	Version	Changes
02-Apr-2012	1	First issue.
27-Jun-2018	2	Updated Table 1. Absolute Ratings (limiting values, per diode, at 25 °C, unless otherwise specified) and Figure 3. Normalized avalanche power derating versus pulse duration (T_j = 125 °C) . Removed TO-220AB narrow leads and I ² PAK package information.
13-Nov-2018	3	Updated Table 5 .

IMPORTANT NOTICE – PLEASE READ CAREFULLY

STMicroelectronics NV and its subsidiaries (“ST”) reserve the right to make changes, corrections, enhancements, modifications, and improvements to ST products and/or to this document at any time without notice. Purchasers should obtain the latest relevant information on ST products before placing orders. ST products are sold pursuant to ST’s terms and conditions of sale in place at the time of order acknowledgement.

Purchasers are solely responsible for the choice, selection, and use of ST products and ST assumes no liability for application assistance or the design of Purchasers’ products.

No license, express or implied, to any intellectual property right is granted by ST herein.

Resale of ST products with provisions different from the information set forth herein shall void any warranty granted by ST for such product.

ST and the ST logo are trademarks of ST. All other product or service names are the property of their respective owners.

Information in this document supersedes and replaces information previously supplied in any prior versions of this document.

© 2018 STMicroelectronics – All rights reserved

单击下面可查看定价，库存，交付和生命周期等信息

[>>STMicro\(意法半导体\)](#)