

Description

These standard SCRs are suitable for applications where in-rush current conditions are critical, such as overvoltage crowbar protection circuits in power supplies, in-rush current limiting circuits, solid state relays (in back to back configuration), welding equipment, high power motor control circuits.

Using clip assembly technology, they provide a superior performance in high surge current capabilities.

Table 1. Device summary

Order code	Voltage	Sensitivity
TYN640RG	600 V	35 mA
TYN840RG	800 V	35 mA

Features

- On-state rms current, $I_{T(RMS)}$: 40 A
- Repetitive peak off-stat voltage, V_{DRM} , V_{RRM} :
 - 600 V
 - 800 V
- Triggering gate current, I_{GT} : 35 mA

1 Characteristics

Table 2. Absolute ratings (limiting values)

Symbol	Parameter		Value	Unit	
$I_{T(RMS)}$	On-state rms current (180° conduction angle)		$T_C = 95\text{ °C}$ 40	A	
$I_{T(AV)}$	Average on-state current (180° conduction angle)		$T_C = 95\text{ °C}$ 25	A	
I_{TSM}	Non repetitive surge peak on-state current	$t_p = 8.3\text{ ms}$	$T_j = 25\text{ °C}$	480	A
		$t_p = 10\text{ ms}$		460	
I^2t	I^2t Value for fusing	$t_p = 10\text{ ms}$	$T_j = 25\text{ °C}$	1060	A^2s
di/dt	Critical rate of rise of on-state current $I_G = 2 \times I_{GT}$, $t_r \leq 100\text{ ns}$	$F = 60\text{ Hz}$	$T_j = 125\text{ °C}$	50	$A/\mu s$
I_{GM}	Peak gate current	$t_p = 20\text{ }\mu s$	$T_j = 125\text{ °C}$	4	A
$P_{G(AV)}$	Average gate power dissipation		$T_j = 125\text{ °C}$	1	W
T_{stg} T_j	Storage junction temperature range Operating junction temperature range			- 40 to + 150 - 40 to + 125	$^{\circ}C$
V_{RGM}	Maximum peak reverse gate voltage			5	V

Table 3. Electrical Characteristics ($T_j = 25\text{ °C}$, unless otherwise specified)

Symbol	Test Conditions		Value	Unit	
I_{GT}	$V_D = 12\text{ V}$ $R_L = 33\text{ }\Omega$	MIN.	3.5	mA	
		MAX.	35		
V_{GT}		MAX.	1.3	V	
V_{GD}	$V_D = V_{DRM}$ $R_L = 3.3\text{ k}\Omega$	$T_j = 125\text{ °C}$	MIN.	0.2	V
I_H	$I_T = 500\text{ mA}$ Gate open		MAX.	75	mA
I_L	$I_G = 1.2 \times I_{GT}$		MAX.	150	mA
dV/dt	$V_D = 67\% V_{DRM}$ Gate open	$T_j = 125\text{ °C}$	MIN.	1000	$V/\mu s$
V_{TM}	$I_{TM} = 80\text{ A}$ $t_p = 380\text{ }\mu s$	$T_j = 25\text{ °C}$	MAX.	1.6	V
V_{t0}	Threshold voltage		$T_j = 125\text{ °C}$ MAX.	0.85	V
R_d	Dynamic resistance		$T_j = 125\text{ °C}$ MAX.	10	$m\Omega$
I_{DRM} I_{RRM}	$V_{DRM} = V_{RRM}$	$T_j = 25\text{ °C}$	MAX.	5	μA
		$T_j = 125\text{ °C}$		4	mA

Table 4. Thermal resistance

Symbol	Parameter	Value	Unit
$R_{th(j-c)}$	Junction to case (DC)	0.8	$^{\circ}C/W$
$R_{th(j-a)}$	Junction to ambient (DC)	60	$^{\circ}C/W$

Figure 1. Maximum average power dissipation versus average on-state current

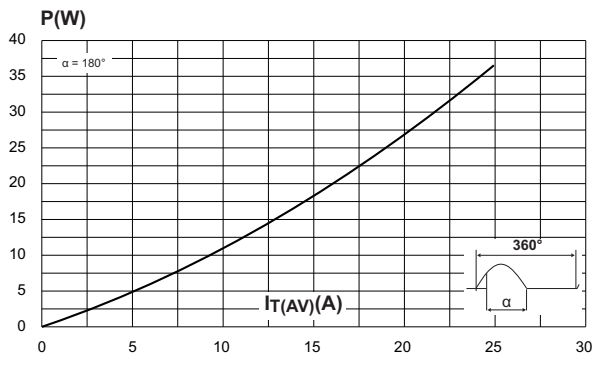

Figure 2. Average and DC on-state current versus case temperature

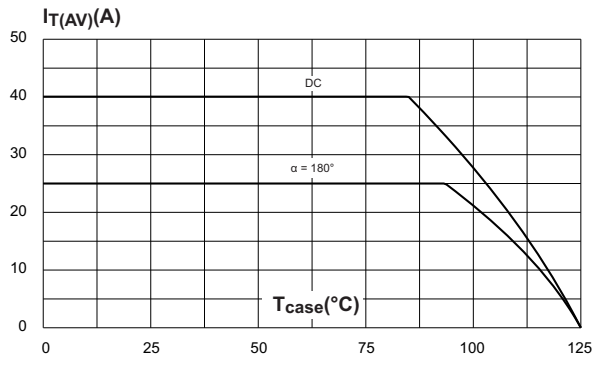

Figure 3. Relative variation of thermal impedance versus pulse duration

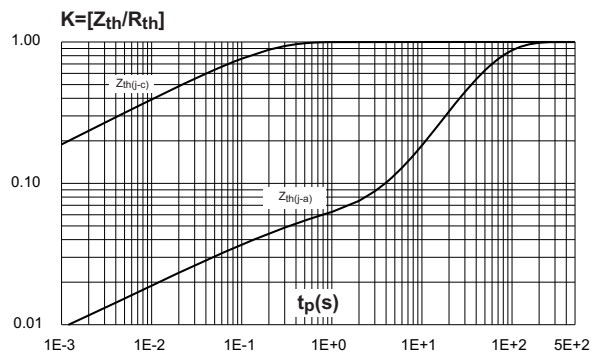

Figure 4. Relative variation of gate trigger current, holding current and latching current versus junction temperature

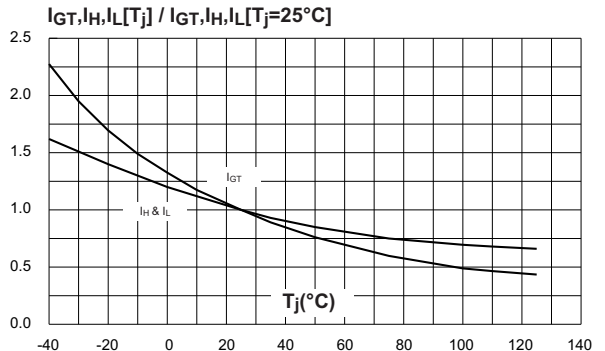

Figure 5. Surge peak on-state current versus number of cycles

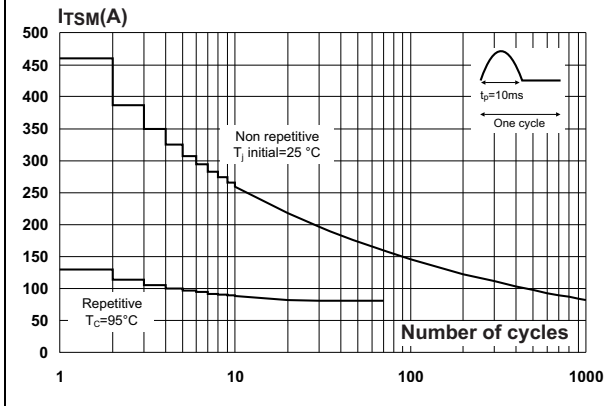

Figure 6. Non-repetitive surge peak on-state current for a sinusoidal pulse with width $t_p < 10$ ms, and corresponding values of I^2t

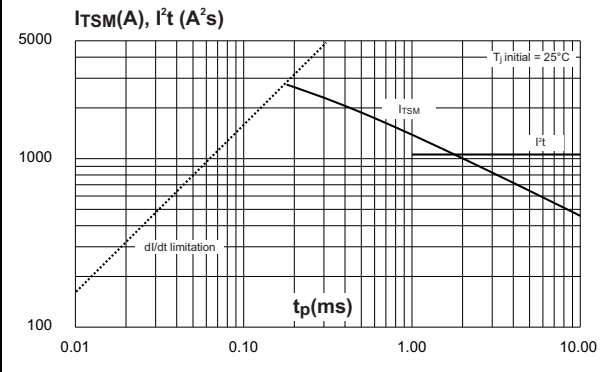
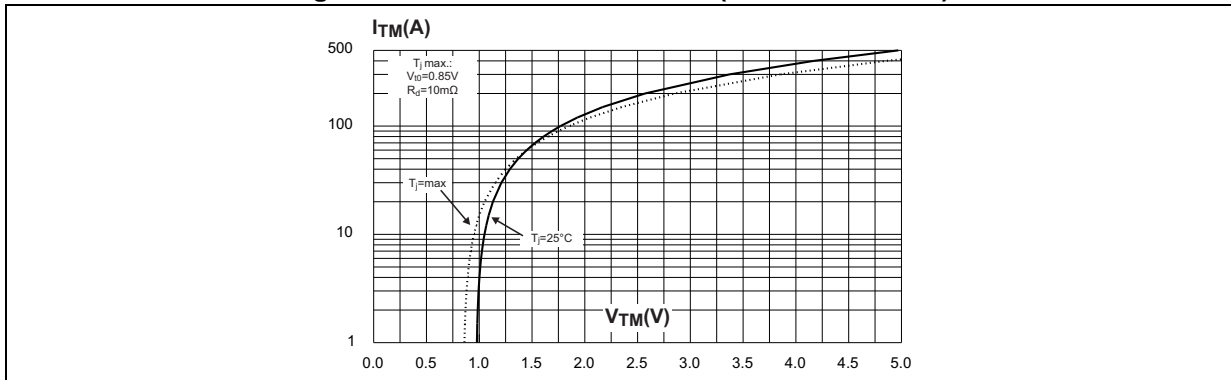

Figure 7. On-state characteristics (maximum values)



2 Package information

- Epoxy meets UL94, V0
- Lead-free package

In order to meet environmental requirements, ST offers these devices in different grades of ECOPACK[®] packages, depending on their level of environmental compliance. ECOPACK[®] specifications, grade definitions and product status are available at: www.st.com. ECOPACK[®] is an ST trademark.

Figure 8. TO-220AB dimension definitions

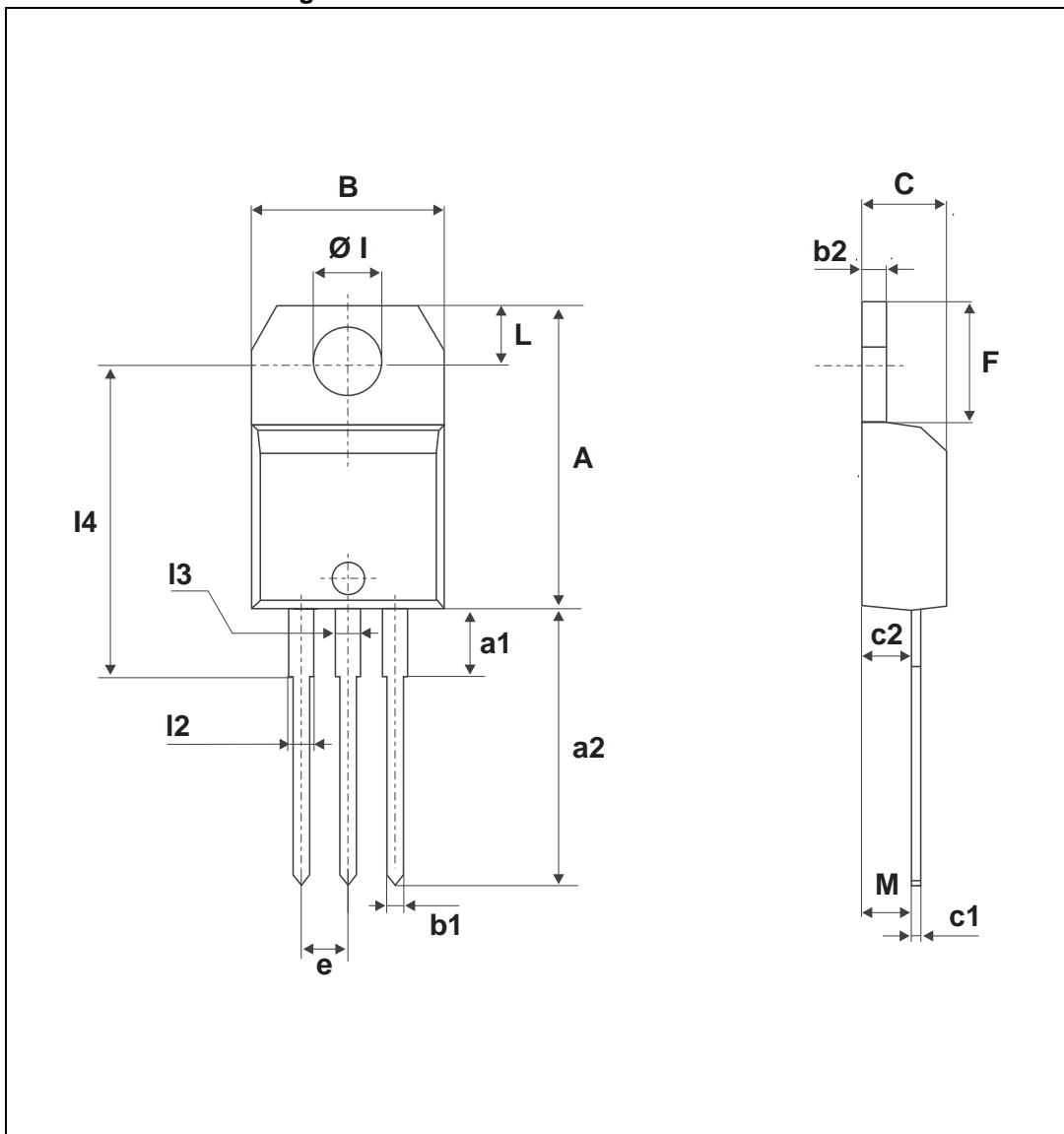

Table 5. TO-220AB dimension values

Ref.	Dimensions					
	Millimeters			Inches		
	Min.	Typ.	Max.	Min.	Typ.	Max.
A	15.20		15.90	0.598		0.625
a1		3.75			0.147	
a2	13.00		14.00	0.511		0.551
B	10.00		10.40	0.393		0.409
b1	0.61		0.88	0.024		0.034
b2	1.23		1.32	0.048		0.051
C	4.40		4.60	0.173		0.181
c1	0.49		0.70	0.019		0.027
c2	2.40		2.72	0.094		0.107
e	2.40		2.70	0.094		0.106
F	6.20		6.60	0.244		0.259
ØI	3.75		3.85	0.147		0.151
l4	15.80	16.40	16.80	0.622	0.646	0.661
L	2.65		2.95	0.104		0.116
l2	1.14		1.70	0.044		0.066
l3	1.14		1.70	0.044		0.066
M		2.60			0.102	

3 Ordering information

Figure 9. Ordering Information Scheme

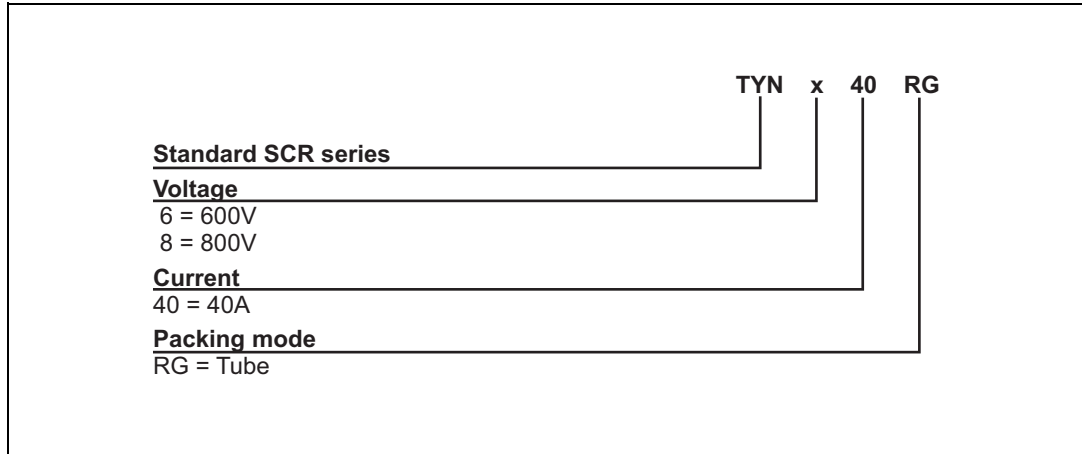

Table 6. Ordering Information

Ordering type	Marking	Package	Weight	Base qty	Delivery mode
TYN640RG	TYN640	TO-220AB	2.3 g	50	Tube
TYN840RG	TYN840				

4 Revision history

Table 7. Document revision history

Date	Revision	Changes
Apr-2002	4A	Last update.
13-Feb-2006	5	TO-220AB delivery mode changed from bulk to tube. ECOPACK statement added.
05-Nov-2013	6	Updated Figure 5 .

Please Read Carefully:

Information in this document is provided solely in connection with ST products. STMicroelectronics NV and its subsidiaries ("ST") reserve the right to make changes, corrections, modifications or improvements, to this document, and the products and services described herein at any time, without notice.

All ST products are sold pursuant to ST's terms and conditions of sale.

Purchasers are solely responsible for the choice, selection and use of the ST products and services described herein, and ST assumes no liability whatsoever relating to the choice, selection or use of the ST products and services described herein.

No license, express or implied, by estoppel or otherwise, to any intellectual property rights is granted under this document. If any part of this document refers to any third party products or services it shall not be deemed a license grant by ST for the use of such third party products or services, or any intellectual property contained therein or considered as a warranty covering the use in any manner whatsoever of such third party products or services or any intellectual property contained therein.

UNLESS OTHERWISE SET FORTH IN ST'S TERMS AND CONDITIONS OF SALE ST DISCLAIMS ANY EXPRESS OR IMPLIED WARRANTY WITH RESPECT TO THE USE AND/OR SALE OF ST PRODUCTS INCLUDING WITHOUT LIMITATION IMPLIED WARRANTIES OF MERCHANTABILITY, FITNESS FOR A PARTICULAR PURPOSE (AND THEIR EQUIVALENTS UNDER THE LAWS OF ANY JURISDICTION), OR INFRINGEMENT OF ANY PATENT, COPYRIGHT OR OTHER INTELLECTUAL PROPERTY RIGHT.

ST PRODUCTS ARE NOT DESIGNED OR AUTHORIZED FOR USE IN: (A) SAFETY CRITICAL APPLICATIONS SUCH AS LIFE SUPPORTING, ACTIVE IMPLANTED DEVICES OR SYSTEMS WITH PRODUCT FUNCTIONAL SAFETY REQUIREMENTS; (B) AERONAUTIC APPLICATIONS; (C) AUTOMOTIVE APPLICATIONS OR ENVIRONMENTS, AND/OR (D) AEROSPACE APPLICATIONS OR ENVIRONMENTS. WHERE ST PRODUCTS ARE NOT DESIGNED FOR SUCH USE, THE PURCHASER SHALL USE PRODUCTS AT PURCHASER'S SOLE RISK, EVEN IF ST HAS BEEN INFORMED IN WRITING OF SUCH USAGE, UNLESS A PRODUCT IS EXPRESSLY DESIGNATED BY ST AS BEING INTENDED FOR "AUTOMOTIVE, AUTOMOTIVE SAFETY OR MEDICAL" INDUSTRY DOMAINS ACCORDING TO ST PRODUCT DESIGN SPECIFICATIONS. PRODUCTS FORMALLY ESCC, QML OR JAN QUALIFIED ARE DEEMED SUITABLE FOR USE IN AEROSPACE BY THE CORRESPONDING GOVERNMENTAL AGENCY.

Resale of ST products with provisions different from the statements and/or technical features set forth in this document shall immediately void any warranty granted by ST for the ST product or service described herein and shall not create or extend in any manner whatsoever, any liability of ST.

ST and the ST logo are trademarks or registered trademarks of ST in various countries.

Information in this document supersedes and replaces all information previously supplied.

The ST logo is a registered trademark of STMicroelectronics. All other names are the property of their respective owners.

© 2013 STMicroelectronics - All rights reserved

STMicroelectronics group of companies

Australia - Belgium - Brazil - Canada - China - Czech Republic - Finland - France - Germany - Hong Kong - India - Israel - Italy - Japan - Malaysia - Malta - Morocco - Philippines - Singapore - Spain - Sweden - Switzerland - United Kingdom - United States of America

www.st.com

单击下面可查看定价，库存，交付和生命周期等信息

[>>STMicro\(意法半导体\)](#)