

16 A - 800 V - 150 °C 8H Triac in D²PAK

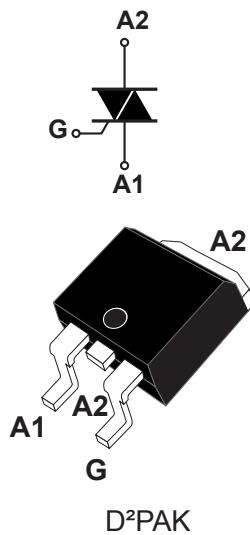

Features

- 16 A medium current Triac
- 800 V symmetrical blocking voltage
- 150 °C maximum junction temperature T_j
- Three triggering quadrants
- High noise immunity - static dV/dt
- Robust dynamic turn-off commutation - $(di/dt)_c$
- ECOPACK2 compliant component
- Molding resin UL94-V0 flammability certified

Applications

- Home automation Smart AC plug
- Water heater, room heater and coffee machine
- AC Induction and Universal Motor control
- Inrush current limiter in AC DC rectifiers
- Lighting and automation I/O control
- General purpose AC line load control

Description

Specifically designed to operate at 800 V and 150 °C, the **T1635H-8G** Triac housed in D²PAK provides an enhanced thermal management: this 16 A triac is the right choice for a compact drive of heavy AC loads and enables the heatsink size reduction.

Based on the ST Snubberless high temperature technology, it offers higher specified turn off commutation and noise immunity levels up to the T_j max.

The **T1635H-8G** safely optimizes the control of the hardest universal motors, heaters and inductive loads for industrial control and home appliances.

Product status link

[T1635H-8G](#)

Product summary

| | |
|-------------------|--------|
| $I_{T(RMS)}$ | 16 A |
| V_{DRM}/V_{RRM} | 800 V |
| V_{DSM}/V_{RSM} | 900 V |
| I_{GT} | 35 mA |
| T_j max. | 150 °C |

1 Characteristics

Table 1. Absolute maximum ratings (limiting values)

| Symbol | Parameter | Value | Unit | |
|-------------------|---|------------------------|------------------|---|
| $I_{T(RMS)}$ | RMS on-state current (full sine wave) $T_c = 131\text{ °C}$ | 16 | A | |
| I_{TSM} | Non repetitive surge peak on-state current (full cycle, T_j initial = 25 °C) | $t_p = 16.7\text{ ms}$ | 168 | A |
| | | $t_p = 20\text{ ms}$ | 160 | |
| I^2t | I^2t value for fusing $t_p = 10\text{ ms}$ | 169 | A ² s | |
| di/dt | Critical rate of rise of on-state current, $I_G = 2 \times I_{GT}$, $tr \leq 100\text{ ns}$, $f = 100\text{ Hz}$ $T_j = 25\text{ °C}$ | 100 | A/ μ s | |
| V_{DRM}/V_{RRM} | Repetitive peak off-state voltage | 800 | V | |
| V_{DSM}/V_{RSM} | Non Repetitive peak off-state voltage $t_p = 10\text{ ms}$, $T_j = 25\text{ °C}$ | 900 | V | |
| I_{GM} | Peak gate current $t_p = 20\text{ }\mu$ s, $T_j = 150\text{ °C}$ | 4 | A | |
| P_{GM} | Maximum gate power dissipation | 5 | W | |
| $P_{G(AV)}$ | Average gate power dissipation $T_j = 150\text{ °C}$ | 1 | W | |
| T_{stg} | Storage temperature range | -40 to +150 | °C | |
| T_j | Operating junction temperature range | -40 to +150 | °C | |

Table 2. Electrical characteristics ($T_j = 25\text{ °C}$, unless otherwise specified)

| Symbol | Test conditions | Quadrants | | Value | Unit |
|-------------------|---|-----------------------|------|-------|------------|
| I_{GT} | $V_D = 12\text{ V}$, $R_L = 30\text{ }\Omega$ | I - II - III | Min. | 5 | mA |
| | | | Max. | 35 | mA |
| V_{GT} | $V_D = 12\text{ V}$, $R_L = 30\text{ }\Omega$ | I - II - III | Max. | 1.3 | V |
| V_{GD} | $V_D = V_{DRM}$, $R_L = 3.3\text{ k}\Omega$ $T_j = 150\text{ °C}$ | I - II - III | Min. | 0.15 | V |
| I_L | $I_G = 1.2 \times I_{GT}$ | I - III | Max. | 50 | mA |
| | | II | Max. | 80 | mA |
| $I_H^{(1)}$ | $I_T = 500\text{ mA}$, gate open | | Max. | 35 | mA |
| $dV/dt^{(1)}$ | $V_D = 536\text{ V}$, gate open | $T_j = 150\text{ °C}$ | Min. | 2000 | V/ μ s |
| $(di/dt)_c^{(1)}$ | Without snubber network | $T_j = 150\text{ °C}$ | Min. | 16 | A/ms |

1. For both polarities of A2 referenced to A1.

Table 3. Static characteristics

| Symbol | Test conditions | T_j | | Value | Unit |
|-------------------|--|--------|------|-------|------|
| $V_{TM}^{(1)}$ | $I_T = 22\text{ A}$, $t_p = 380\ \mu\text{s}$ | 25 °C | Max. | 1.50 | V |
| $V_{TO}^{(1)}$ | Threshold voltage | 150 °C | Max. | 0.80 | V |
| $R_D^{(1)}$ | Dynamic resistance | 150 °C | Max. | 23 | mΩ |
| I_{DRM}/I_{RRM} | $V_D = V_R = V_{DRM} = V_{RRM}$ | 25 °C | Max. | 2.0 | μA |
| | | 150 °C | | 5.5 | mA |
| | $V_D = V_R = 400\text{ V}$, peak voltage | 150 °C | Max. | 2.3 | mA |

1. For both polarities of A2 referenced to A1.

Table 4. Thermal resistance

| Symbol | Parameter | | Value | Unit |
|---------------|--|------|-------|------|
| $R_{th(j-c)}$ | Junction to case (AC) | Max. | 1.1 | °C/W |
| $R_{th(j-a)}$ | Junction to ambient ($S_{Cu}^{(1)} = 2\text{ cm}^2$) | Typ. | 45 | °C/W |

1. S_{Cu} : copper pad surface under tab, 35 μm copper thickness on FR4 PCB.

1.1 Characteristics (curves)

Figure 1. Maximum power dissipation versus on-state RMS current

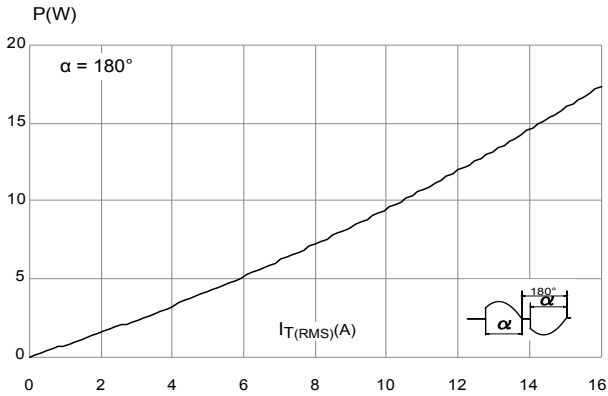

Figure 2. On-state RMS current versus case temperature

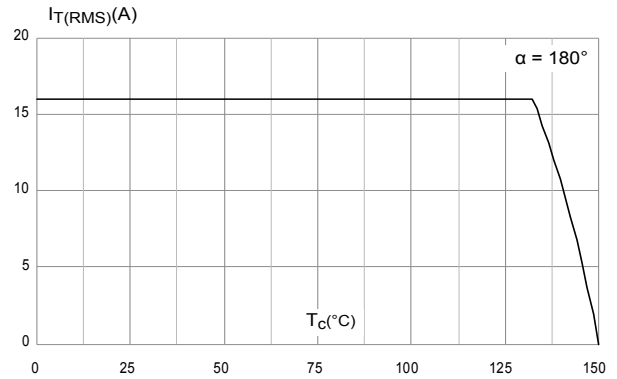

Figure 3. On-state RMS current versus ambient temperature (free air convection)

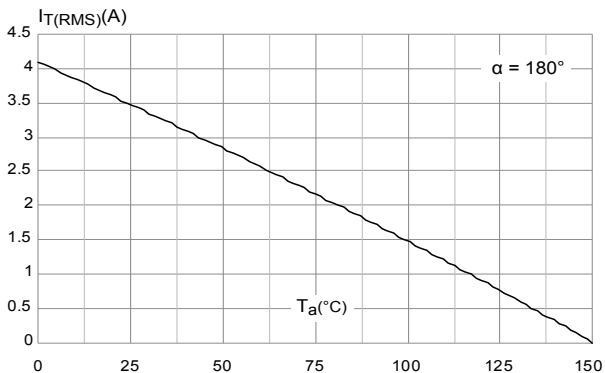

Figure 4. On-state characteristics (maximum values)

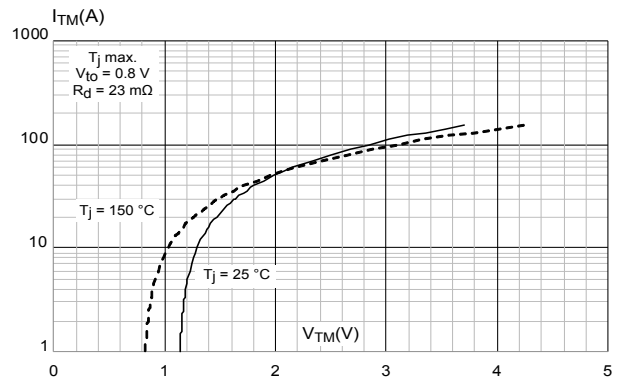

Figure 5. Relative variation of thermal impedance versus pulse duration

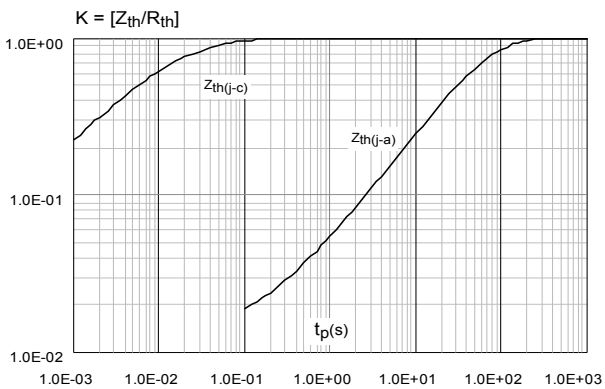

Figure 6. Recommended maximum case-to-ambient thermal resistance versus ambient temperature for different peak off-state voltages

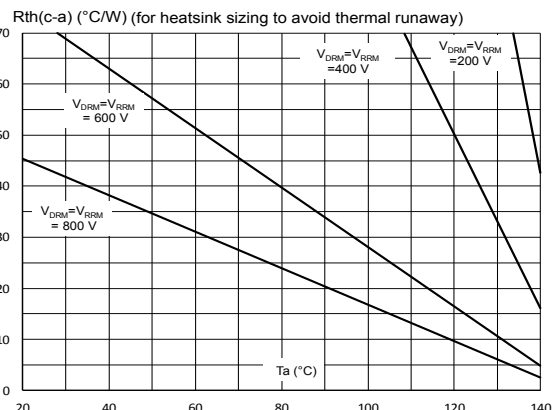

Figure 7. Thermal resistance junction to ambient versus copper surface under tab

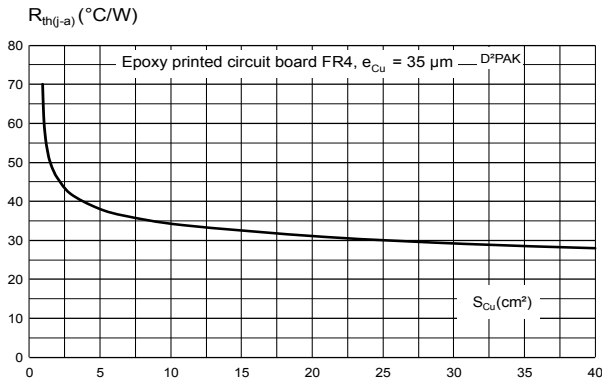

Figure 8. Relative variation of leakage current versus junction temperature for different values of blocking voltage

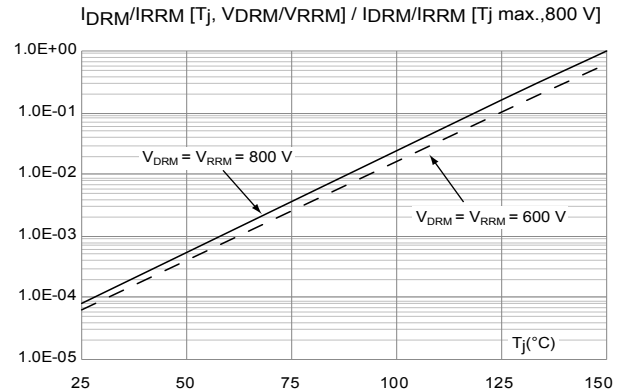

Figure 9. Relative variation of gate trigger voltage and current versus junction temperature (typical values)

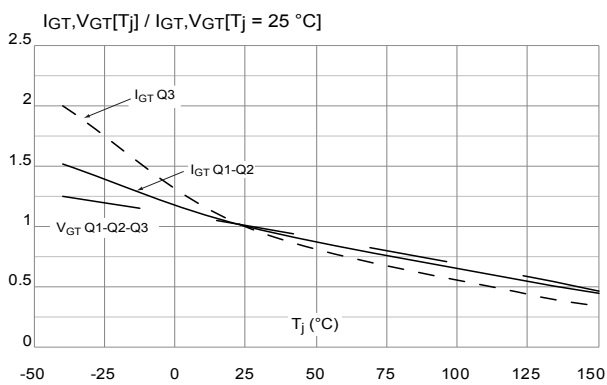

Figure 10. Relative variation of holding current and latching current versus junction temperature (typical values)

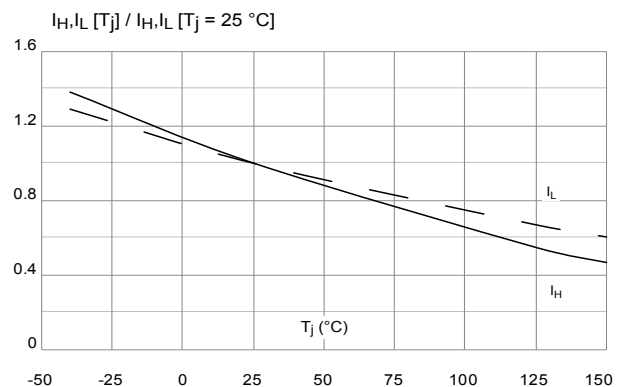

Figure 11. Surge peak on-state current versus number of cycles

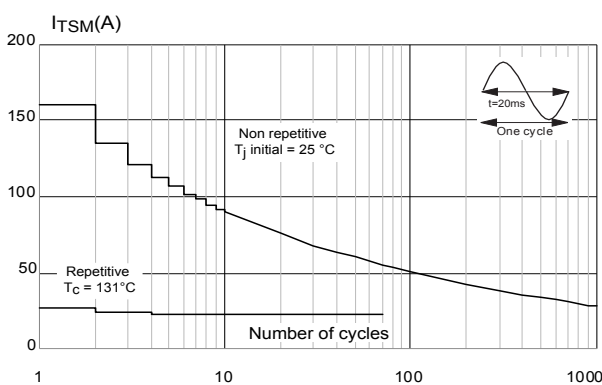

Figure 12. Non repetitive surge peak on-state current for a sinusoidal pulse with width $t_p < 10$ ms

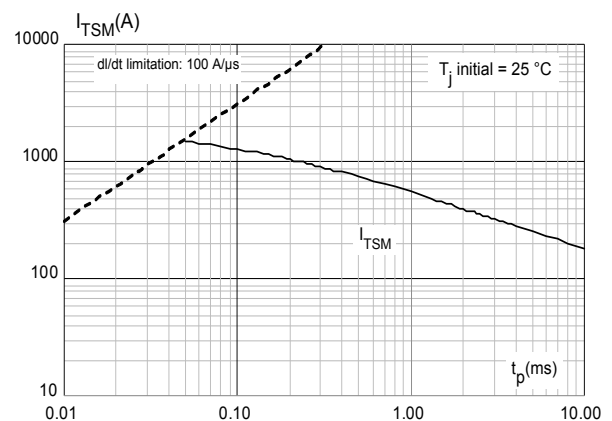

Figure 13. Relative variation of static dV/dt immunity versus junction temperature

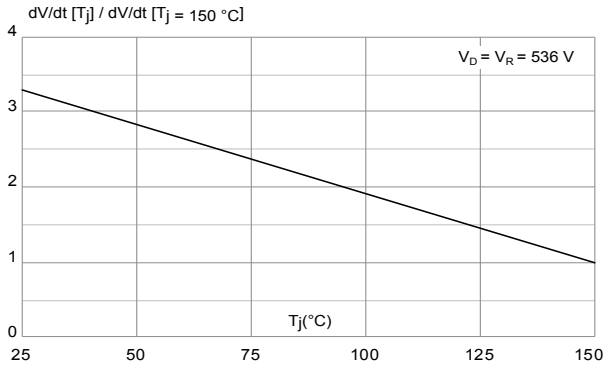
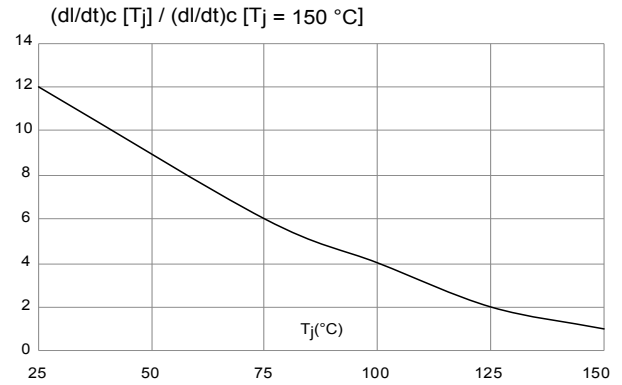

Figure 14. Relative variation of critical rate of decrease of main current versus junction temperature



2 Package information

In order to meet environmental requirements, ST offers these devices in different grades of **ECOPACK** packages, depending on their level of environmental compliance. ECOPACK specifications, grade definitions and product status are available at: www.st.com. ECOPACK is an ST trademark.

2.1 D²PAK package information

- ECOPACK2 compliant
- Lead-free package leads finishing
- Molding compound resin is halogen-free and meets UL94 flammability standard level V0

Figure 15. D²PAK package outline

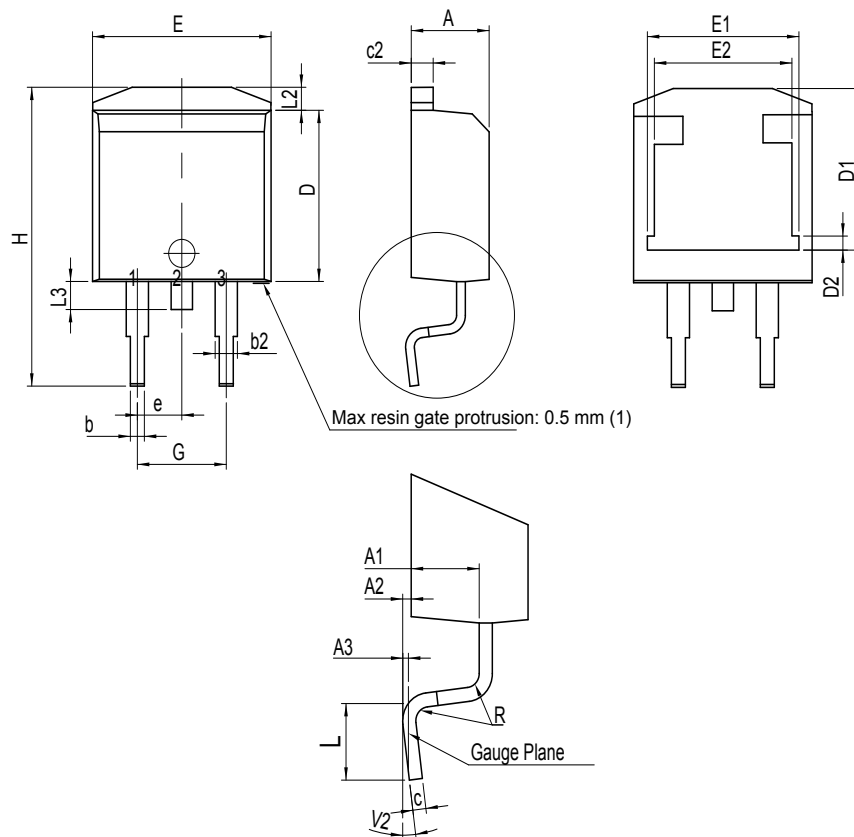

(1) Resin gate is accepted in each of position shown on the drawing, or their symmetrical.

Table 5. D²PAK package mechanical data

| Ref. | Dimensions | | | | | |
|-------------------|-------------|------|-------|-----------------------|--------|--------|
| | Millimeters | | | Inches ⁽¹⁾ | | |
| | Min. | Typ. | Max. | Min. | Typ. | Max. |
| A | 4.30 | | 4.60 | 0.1693 | | 0.1811 |
| A1 | 2.49 | | 2.69 | 0.0980 | | 0.1059 |
| A2 | 0.03 | | 0.23 | 0.0012 | | 0.0091 |
| A3 | | 0.25 | | | 0.0098 | |
| b | 0.70 | | 0.93 | 0.0276 | | 0.0366 |
| b2 | 1.25 | | 1.7 | 0.0492 | | 0.0669 |
| c | 0.45 | | 0.60 | 0.0177 | | 0.0236 |
| c2 | 1.21 | | 1.36 | 0.0476 | | 0.0535 |
| D | 8.95 | | 9.35 | 0.3524 | | 0.3681 |
| D1 | 7.50 | | 8.00 | 0.2953 | | 0.3150 |
| D2 | 1.30 | | 1.70 | 0.0512 | | 0.0669 |
| e | 2.54 | | | 0.10000 | | |
| E | 10.00 | | 10.28 | 0.3937 | | 0.4047 |
| E1 | 8.30 | | 8.70 | 0.3268 | | 0.3425 |
| E2 | 6.85 | | 7.25 | 0.2697 | | 0.2854 |
| G | 4.88 | | 5.28 | 0.1921 | | 0.2079 |
| H | 15 | | 15.85 | 0.5906 | | 0.6240 |
| L | 1.78 | | 2.28 | 0.0701 | | 0.0898 |
| L2 | 1.19 | | 1.40 | 0.0468 | | 0.0551 |
| L3 | 1.40 | | 1.75 | 0.0551 | | 0.0689 |
| R | | 0.40 | | | 0.0157 | |
| V2 ⁽²⁾ | 0° | | 8° | 0° | | 8° |

1. Dimensions in inches are given for reference only

2. Degrees

Figure 16. D²PAK recommended footprint (dimensions are in mm)

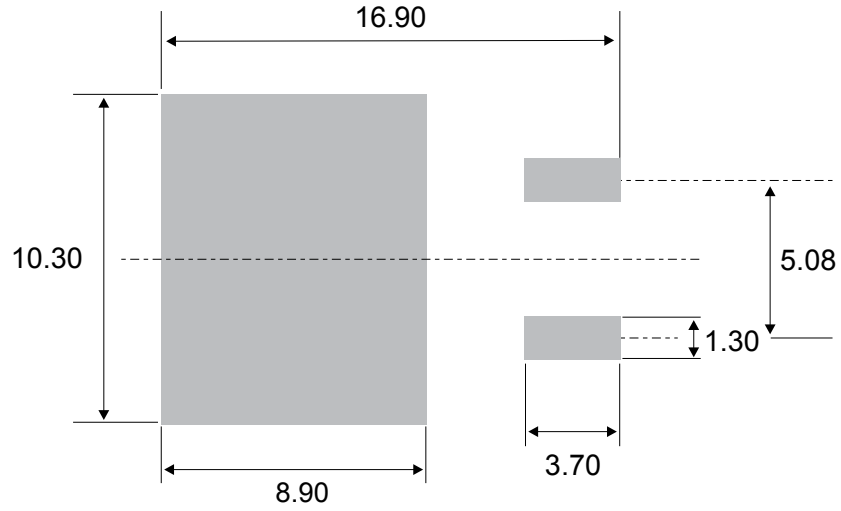
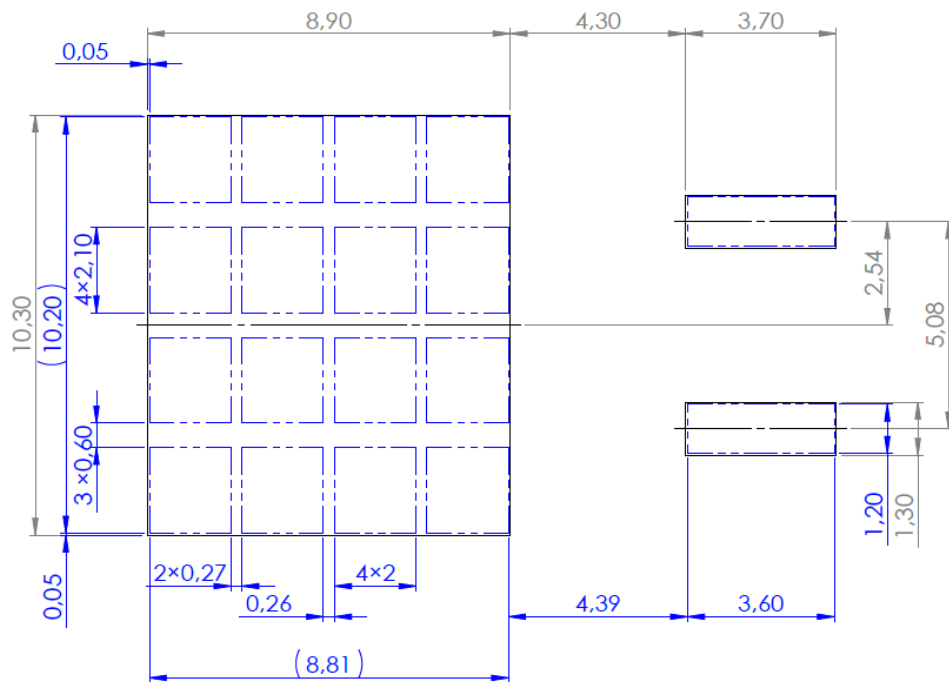

Figure 17. D²PAK stencil definitions (dimensions are in mm)



3 Ordering information

Figure 18. Ordering information scheme

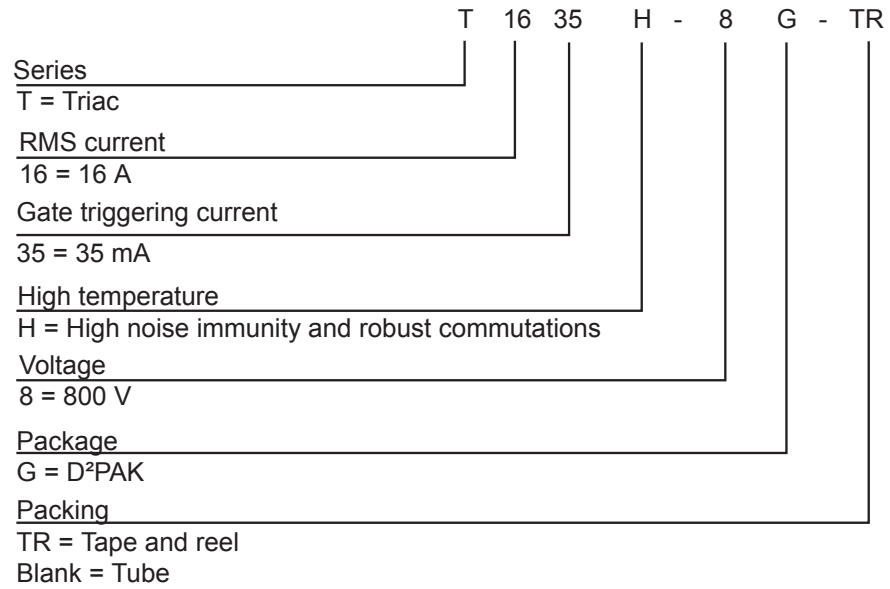

Table 6. Ordering information

| Order code | Marking | Package | Weight | Base qty. | Delivery mode |
|--------------|-----------|--------------------|--------|-----------|-------------------|
| T1635H-8G-TR | T1635H-8G | D ² PAK | 1.6 g | 1000 | Tape and reel 13" |
| T1635H-8G | | | | 50 | Tube |

Revision history

Table 7. Document revision history

| Date | Version | Changes |
|-------------|---------|--|
| 27-Jan-2020 | 1 | Initial release. |
| 21-Dec-2020 | 2 | Updated general description and Table 6 . Inserted STPOWER logo. |

IMPORTANT NOTICE – PLEASE READ CAREFULLY

STMicroelectronics NV and its subsidiaries (“ST”) reserve the right to make changes, corrections, enhancements, modifications, and improvements to ST products and/or to this document at any time without notice. Purchasers should obtain the latest relevant information on ST products before placing orders. ST products are sold pursuant to ST’s terms and conditions of sale in place at the time of order acknowledgement.

Purchasers are solely responsible for the choice, selection, and use of ST products and ST assumes no liability for application assistance or the design of Purchasers’ products.

No license, express or implied, to any intellectual property right is granted by ST herein.

Resale of ST products with provisions different from the information set forth herein shall void any warranty granted by ST for such product.

ST and the ST logo are trademarks of ST. For additional information about ST trademarks, please refer to www.st.com/trademarks. All other product or service names are the property of their respective owners.

Information in this document supersedes and replaces information previously supplied in any prior versions of this document.

© 2020 STMicroelectronics – All rights reserved

单击下面可查看定价，库存，交付和生命周期等信息

[>>STMicro\(意法半导体\)](#)