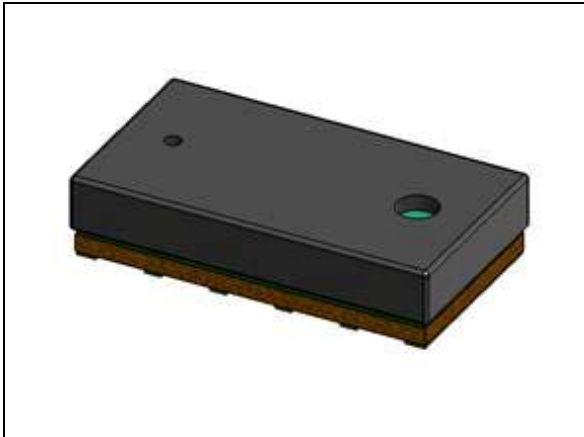

Time-of-Flight ranging sensor[Datasheet - production data](#)**Features**

- Fully integrated miniature module
 - 940 nm laser VCSEL
 - VCSEL driver
 - Ranging sensor with advanced embedded micro controller
 - 4.4 x 2.4 x 1.0 mm
- Fast, accurate distance ranging
 - Measures absolute range up to 2 m
 - Reported range is independent of the target reflectance
 - Advanced embedded optical crosstalk compensation to simplify cover glass selection
- Eye safe
 - Class 1 laser device compliant with latest standard IEC 60825-1:2014 - 3rd edition
- Easy integration
 - Single reflowable component
 - No additional optics
 - Single power supply
 - I2C interface for device control and data transfer
 - Xshutdown (reset) and interrupt GPIO
 - Programmable I2C address

Applications

- Access control (system activation and presence detection)
- Robotics (collision avoidance, wall tracking, cliff detection)
- Home appliance and Home automation
- Inventory management and liquid level monitoring

Description

The VL53L0X is a Time-of-Flight (ToF) laser-ranging module housed in the smallest package on the market today, providing accurate distance measurement whatever the target reflectance, unlike conventional technologies. It can measure absolute distances up to 2 m, setting a new benchmark in ranging performance levels, opening the door to various new applications.

The VL53L0X integrates a leading-edge SPAD array (single photon avalanche diodes) and embeds ST's second generation FlightSense patented technology.

The VL53L0X's 940 nm VCSEL emitter (vertical cavity surface-emitting laser), is totally invisible to the human eye, coupled with internal physical infrared filters, it enables longer ranging distances, higher immunity to ambient light, and better robustness to cover glass optical crosstalk.

Contents

- 1 Overview 4**
 - 1.1 Technical specification 4
 - 1.2 System block diagram 4
 - 1.3 Device pinout 5
 - 1.4 Application schematic 6

- 2 Functional description 7**
 - 2.1 System functional description 7
 - 2.2 Firmware state machine description 8
 - 2.3 Customer manufacturing calibration flow 9
 - 2.3.1 SPAD and temperature calibration 10
 - 2.3.2 Ranging offset calibration 10
 - 2.3.3 Crosstalk calibration 11
 - 2.4 Ranging operating modes 11
 - 2.5 Ranging profiles 12
 - 2.6 Ranging profile phases 12
 - 2.6.1 Initialization and load calibration data phase 13
 - 2.6.2 Ranging phase 13
 - 2.6.3 Digital housekeeping 13
 - 2.7 Getting the data: interrupt or polling 14
 - 2.8 Device programming and control 14
 - 2.9 Power sequence 14
 - 2.9.1 Power up and boot sequence 14
 - 2.10 Ranging sequence 15

- 3 Control interface 16**
 - 3.1 I²C interface - timing characteristics 18
 - 3.2 I²C interface - reference registers 19

- 4 Electrical characteristics 20**
 - 4.1 Absolute maximum ratings 20
 - 4.2 Recommended operating conditions 20



4.3	ESD	20
4.4	Current consumption	21
4.5	Electrical characteristics	22
5	Performance	23
5.1	Measurement conditions	23
5.2	Max ranging distance	24
5.3	Ranging accuracy	25
5.3.1	Standard deviation	25
5.3.2	Range profile examples	26
5.3.3	Ranging offset error	26
6	Outline drawing	27
7	Laser safety considerations	30
8	Packaging and labeling	31
8.1	Product marking	31
8.2	Inner box labeling	31
8.3	Packing	31
8.3.1	Tape outline drawings	32
8.4	Pb-free solder reflow process	32
8.5	Handling and storage precautions	34
8.5.1	Shock precaution	34
8.5.2	Part handling	34
8.5.3	Compression force	34
8.5.4	Moisture sensitivity level	34
8.6	Storage temperature conditions	34
9	Ordering information	35
10	Acronyms and abbreviations	35
11	ECOPACK	36
12	Revision history	37

1 Overview

1.1 Technical specification

Table 1. Technical specification

Feature	Detail
Package	Optical LGA12
Size	4.40 x 2.40 x 1.00 mm
Operating voltage	2.6 to 3.5 V
Operating temperature:	-20 to 70°C
Infrared emitter	940 nm
I ² C	Up to 400 kHz (FAST mode) serial bus Address: 0x52

1.2 System block diagram

Figure 1. VL53L0X block diagram

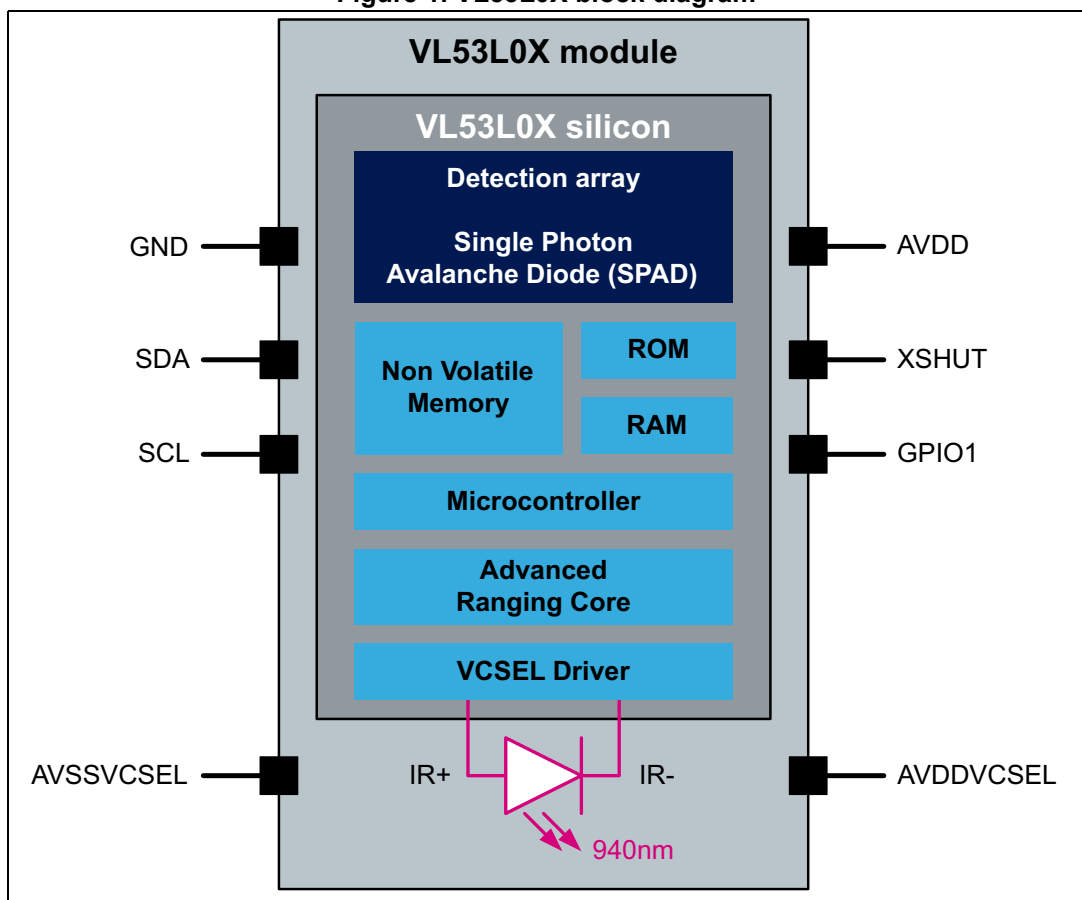

1.3 Device pinout

Figure 2 shows the pinout of the VL53L0X (see also Figure 22).

Figure 2. VL53L0X pinout (bottom view)

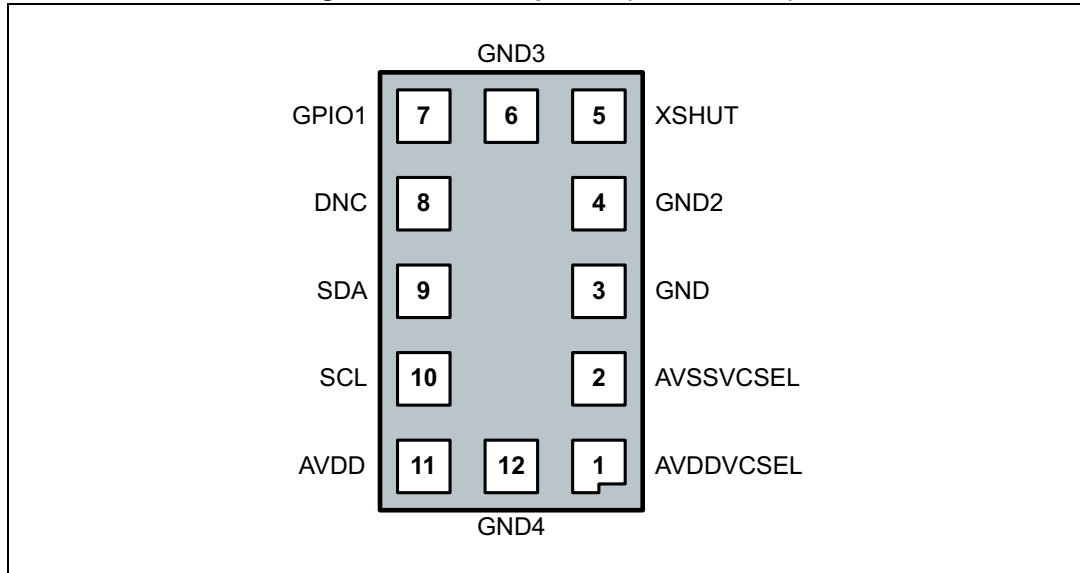

Table 2. VL53L0X pin description

Pin number	Signal name	Signal type	Signal description
1	AVDDVCSEL	Supply	VCSEL Supply, to be connected to main supply
2	AVSSVCSEL	Ground	VCSEL Ground, to be connected to main ground
3	GND	Ground	To be connected to main ground
4	GND2	Ground	To be connected to main ground
5	XSHUT	Digital input	Xshutdown pin, Active LOW
6	GND3	Ground	To be connected to main ground
7	GPIO1	Digital output	Interrupt output. Open drain output.
8	DNC	Digital input	Do Not Connect, must be left floating.
9	SDA	Digital input/output	I ² C serial data
10	SCL	Digital input	I ² C serial clock input
11	AVDD	Supply	Supply, to be connected to main supply
12	GND4	Ground	To be connected to main ground

1.4 Application schematic

Figure 3 shows the application schematic of the VL53L0X.

Figure 3. VL53L0X schematic

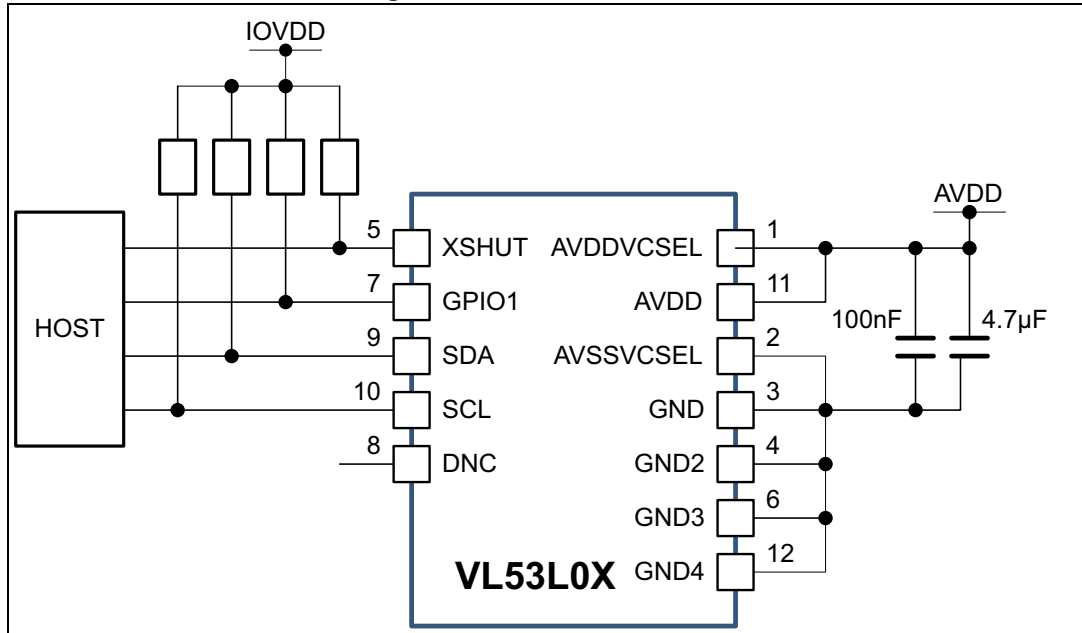

- Note: Capacitors on external supply AVDD should be placed as close as possible to the AVDDVCSEL and AVSSVCSEL module pins.
- Note: External pull-up resistors values can be found in I2C-bus specification. Pull-up are typically fitted only once per bus, near the host. Recommended values for pull-up resistors for an AVDD of 2.8V and 400KHz I²C clock would be 1.5k to 2k Ohms.
- Note: XSHUT pin must always be driven to avoid leakage current. Pull-up is needed if the host state is not known. XSHUT is needed to use HW standby mode (no I²C comm).
- Note: XSHUT and GPIO1 pull up recommended values are 10k Ohms
- Note: GPIO1 to be left unconnected if not used

2 Functional description

2.1 System functional description

Figure 4 shows the system level functional description. The host customer application is controlling the VL53L0X device using an API (Application Programming Interface).

The API is exposing to the customer application a set of high level functions that allows control of the VL53L0X Firmware (FW) like initialization/calibration, ranging Start/Stop, choice of accuracy, choice of ranging mode.

The API is a turnkey solution, it consists of a set of C functions which enables fast development of end user applications, without the complication of direct multiple register access. The API is structured in a way that it can be compiled on any kind of platform through a well isolated platform layer.

The API package allows the user to take full benefit of VL53L0X capabilities.

A detailed description of the API is available in the VL53L0X API User Manual (separate document, DocID029105).

VL53L0X FW fully manages the hardware (HW) register accesses.

Section 2.2: Firmware state machine description details the Firmware state machine.

Figure 4. VL53L0X system functional description

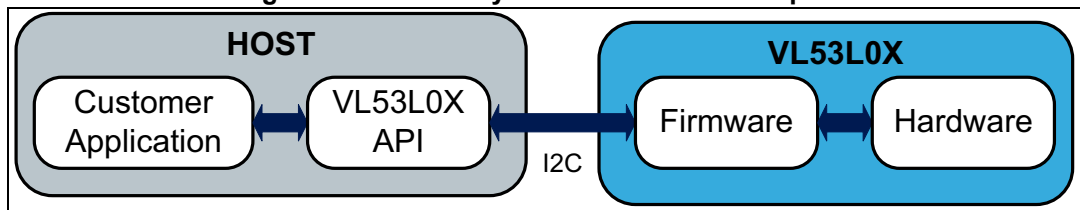

2.2 Firmware state machine description

Figure 5 shows the Firmware state machine.

Figure 5. Firmware state machine

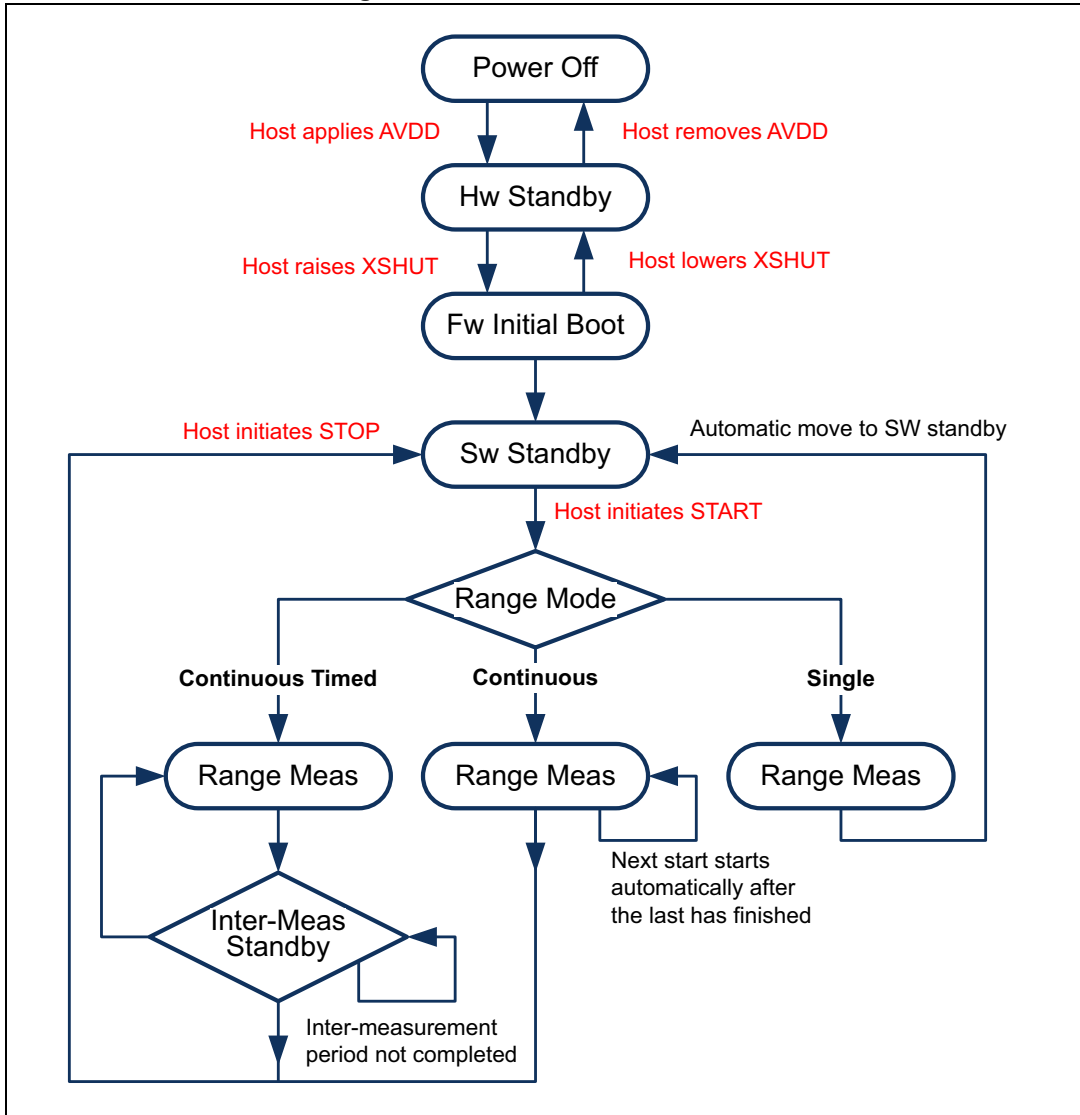

2.3 Customer manufacturing calibration flow

Figure 6 shows the recommended calibration flow that should be applied at customer level, at factory, once only. This flow takes into account all parameters (cover glass, temperature and voltage) from the application.

Figure 6. Customer manufacturing calibration flow

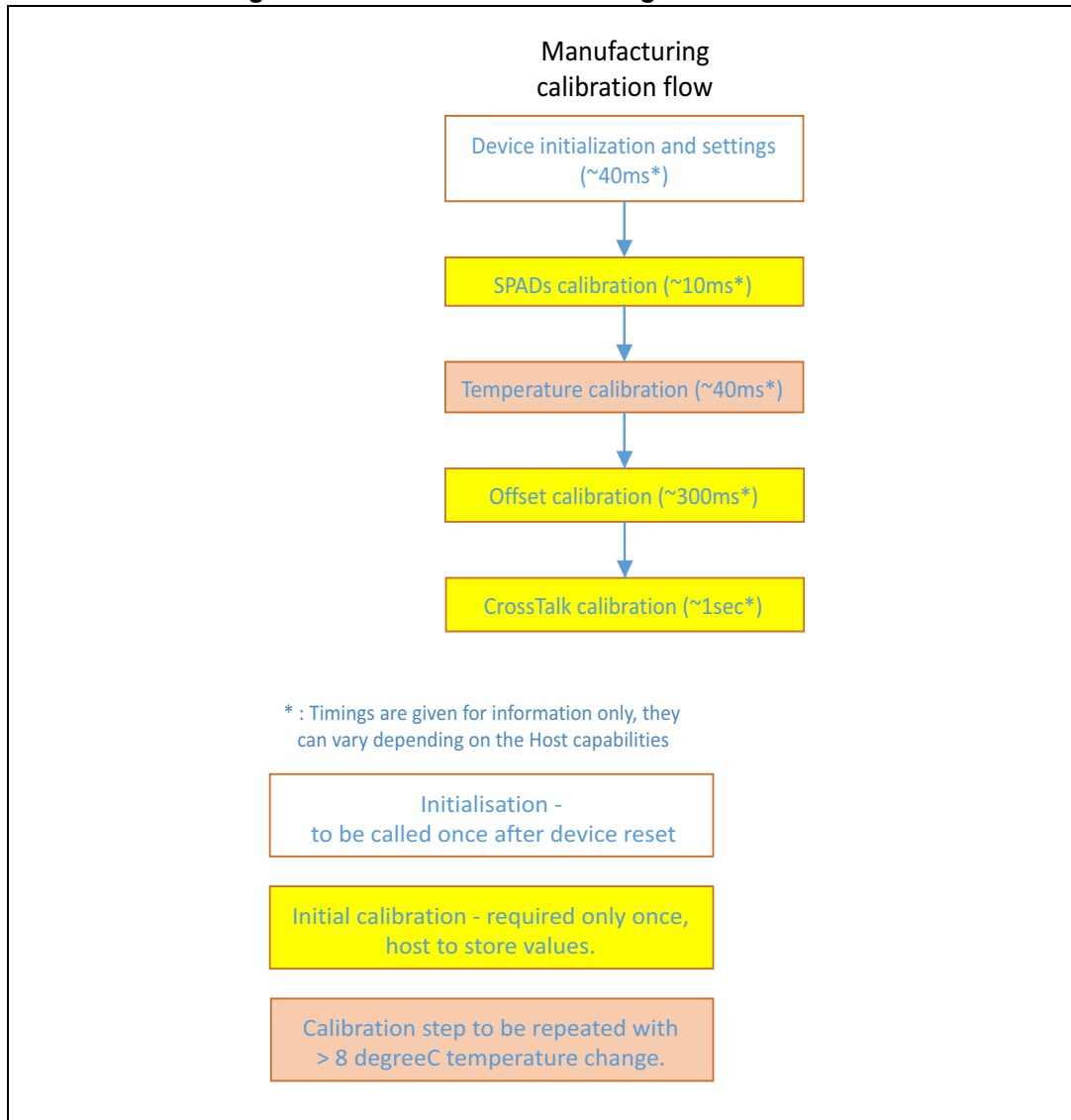

2.3.1 SPAD and temperature calibration

In order to optimize the dynamic of the system, the reference SPADs have to be calibrated. Reference SPAD calibration needs to be done only once during the initial manufacturing calibration, the calibration data should then be stored on the Host.

Temperature calibration is the calibration of two parameters (VHV and phase cal) which are temperature dependent. These two parameters are used to set the device sensitivity. Calibration should be performed during initial manufacturing calibration, it must be performed again when temperature varies more than 8degC compared to the initial calibration temperature.

For more details on SPAD and temperature calibration please refer to the VL53L0X API User Manual.

2.3.2 Ranging offset calibration

Ranging offset can be characterized by the mean offset, which is the centering of the measurement versus the real distance.

Offset calibration should be performed at factory for optimal performances (recommended at 10 cm). The offset calibration should take into account:

- Supply voltage and temperature
- Protective cover glass above VL53L0X module

Figure 7. Range offset

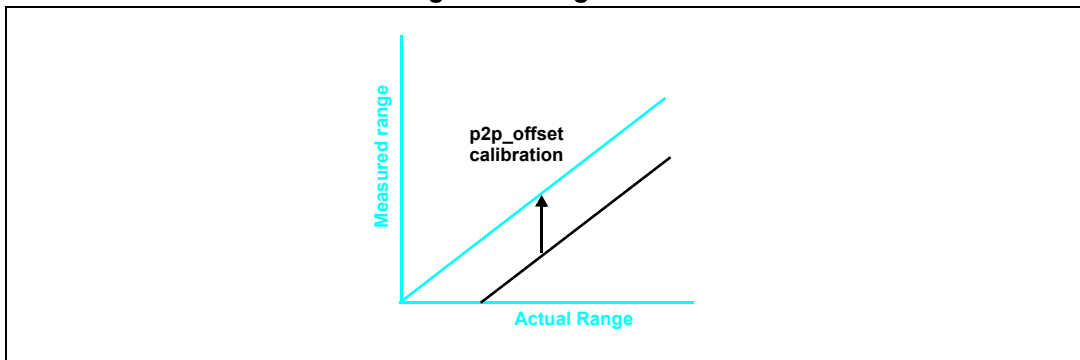

2.3.3 Crosstalk calibration

Crosstalk is defined as the signal return from the cover glass. The magnitude of the crosstalk depends on the type of glass and air gap. Crosstalk results in a range error which is proportional to the ratio of the crosstalk to the signal return from the target.

Figure 8. Crosstalk compensation

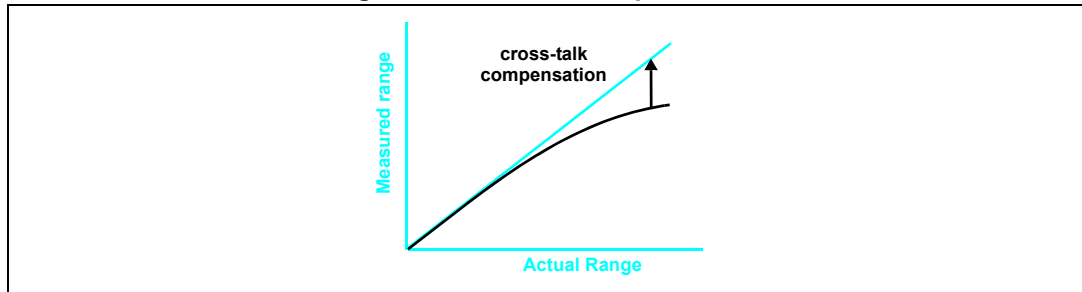

Full offset and crosstalk calibration procedure is described in the VL53L0X API User Manual.

2.4 Ranging operating modes

There are 3 ranging modes available in the API:

1. Single ranging
Ranging is performed only once after the API function is called. System returns to SW standby automatically.
2. Continuous ranging
Ranging is performed in a continuous way after the API function is called. As soon as the measurement is finished, another one is started without delay. User has to stop the ranging to return to SW standby. The last measurement is completed before stopping.
3. Timed ranging
Ranging is performed in a continuous way after the API function is called. When a measurement is finished, another one is started after a user defined delay. This delay (inter-measurement period) can be defined through the API.

User has to stop the ranging to return to SW standby.

If the stop request comes during a range measurement, the measurement is completed before stopping. If it happens during an inter-measurement period, the range measurement stops immediately.

2.5 Ranging profiles

There are 4 different ranging profiles available via API example code. Customers can create their own ranging profile dependent on their use case performance requirements. For more details please refer to the VL53L0X API User Manual.

1. Default mode
2. High speed
3. High accuracy
4. Long range

2.6 Ranging profile phases

Each range profile consists of three consecutive phases:

- Initialization and load calibration data
- Ranging
- Digital housekeeping

Figure 9. Typical initialization / ranging / housekeeping phases

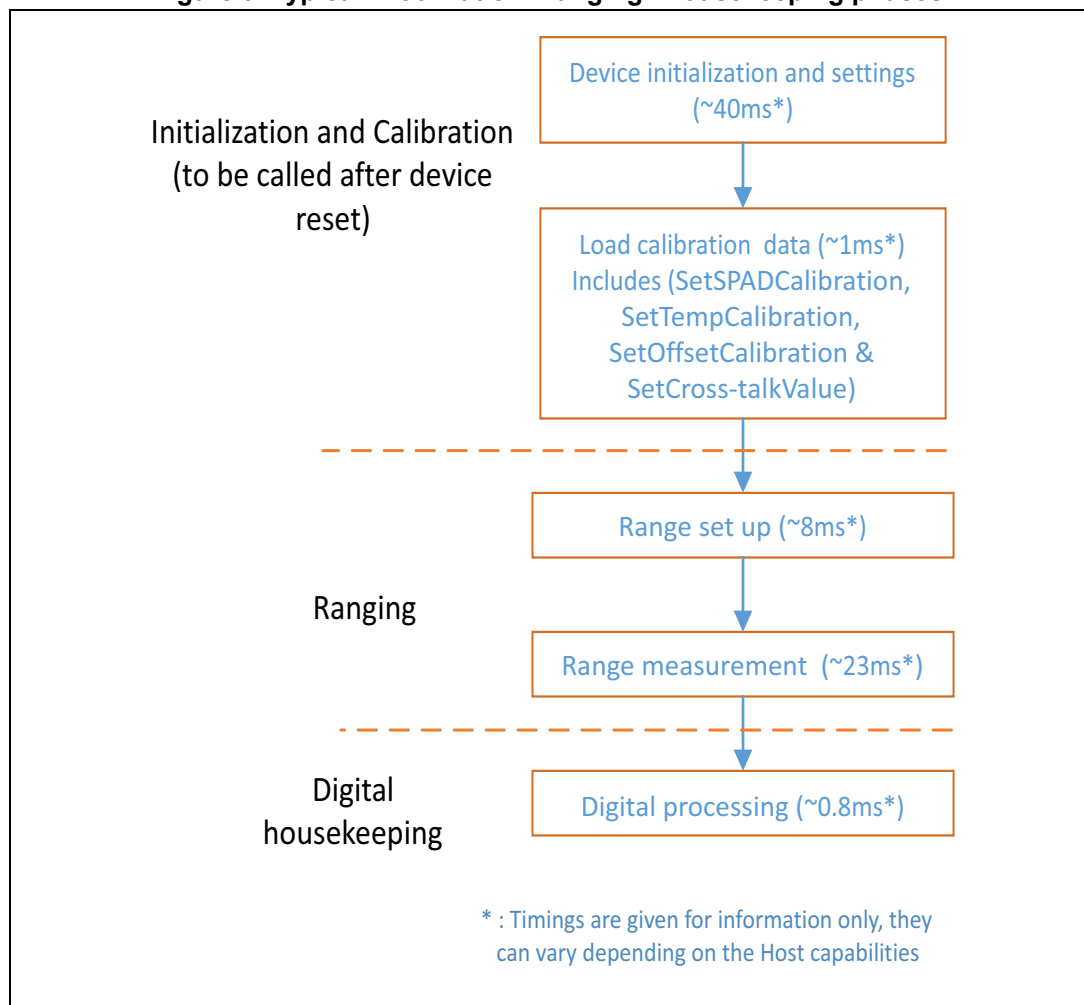

2.6.1 Initialization and load calibration data phase

Initialization and calibration phase is performed before the first ranging or after a device reset, see [Figure 9](#).

The user may then have to repeat the temperature calibration phase in a periodic way, depending on the use case.

For more details on the calibration functions please refer to the VL53L0X API User Manual.

2.6.2 Ranging phase

The ranging phase consists of a range setup then range measurement.

During the ranging operation, several VCSEL infrared pulses are emitted, then reflected back by the target object, and detected by the receiving array. The photo detector used inside VL53L0X is using advanced ultra-fast SPAD technology (Single Photon Avalanche Diodes), protected by several patents.

The typical timing budget for a range is 33 ms (init/ranging/housekeeping), see [Figure 12](#), with the actual range measurement taking 23 ms, see [Figure 9](#). The minimum range measurement period is 8 ms.

2.6.3 Digital housekeeping

Digital processing (housekeeping) is the last operation inside the ranging sequence that computes, validates or rejects a ranging measurement. Part of this processing is performed internally while the other part is executed on the Host by the API.

At the end of the digital processing, the ranging distance is computed by VL53L0X itself. If the distance could not be measured (weak signal, no target...), a corresponding error code is provided.

The following functions are performed on the device itself:

- Signal value check (weak signal)
- Offset correction
- Crosstalk correction (in case of cover glass)
- Final ranging value computation

While the API performs the following:

- Return Ignore Threshold RIT check (Signal check versus cross talk)
- Sigma check (accuracy condition)
- Final ranging state computation

If the user wants to enhance the ranging accuracy, some extra processing (not part of the API) can be carried out by the host, for example, rolling average, hysteresis or any kind of filtering.

2.7 Getting the data: interrupt or polling

User can get the final data using a polling or an interrupt mechanism.

Polling mode: user has to check the status of the ongoing measurement by polling an API function.

Interrupt mode: An interrupt pin (GPIO1) sends an interrupt to the host when a new measurement is available.

The description of these two modes is available in the VL53L0X API User Manual.

2.8 Device programming and control

Device physical control interface is I²C, described in [Section 3: Control interface](#).

A software layer (API) is provided to control the device. The API is described in the VL53L0X API User Manual.

2.9 Power sequence

2.9.1 Power up and boot sequence

There are two options available for device power up/boot.

Option 1: XSHUT pin connected and controlled from host.

This option helps to optimize power consumption as the VL53L0X can be completely powered off when not used, and then woken up through host GPIO (using XSHUT pin).

HW Standby mode is defined as the period when AVDD is present and XSHUT is low.

Figure 10. Power up and boot sequence

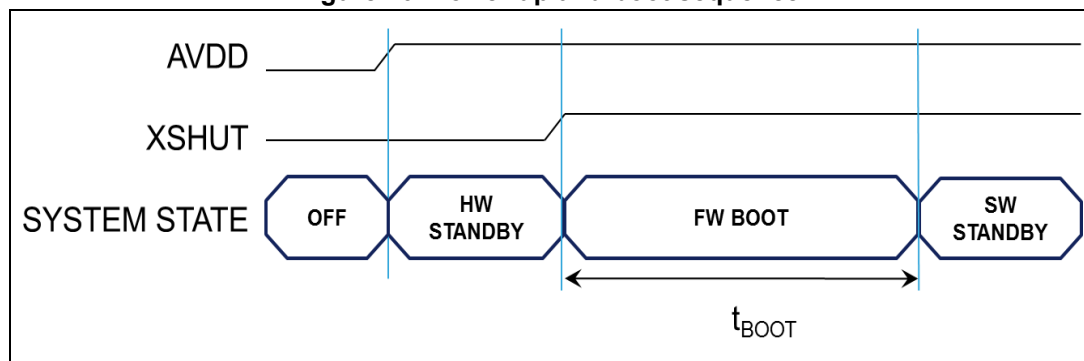

t_{BOOT} is 1.2 ms max.

Option 2: XSHUT pin not controlled by host, and tied to AVDD through pull-up resistor.

In case XSHUT pin is not controlled, the power up sequence is presented in [Figure 11](#). In this case, the device is going automatically in SW STANDBY after FW BOOT, without entering HW STANDBY.

Figure 11. Power up and boot sequence with XSHUT not controlled

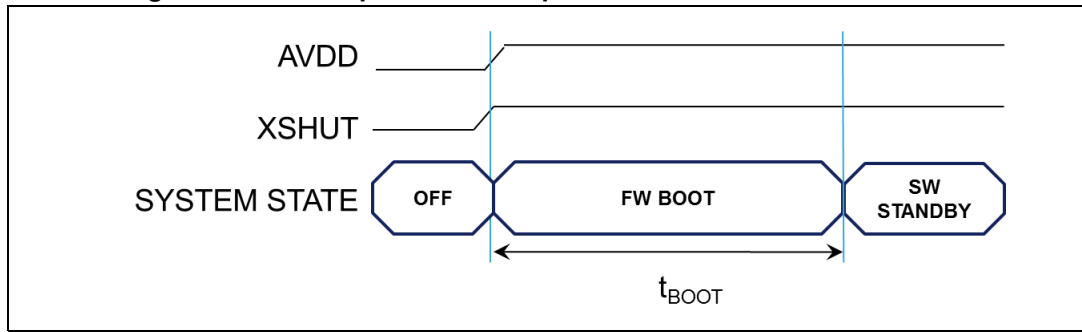

t_{BOOT} is 1.2 ms max.

2.10 Ranging sequence

Figure 12. Ranging sequence

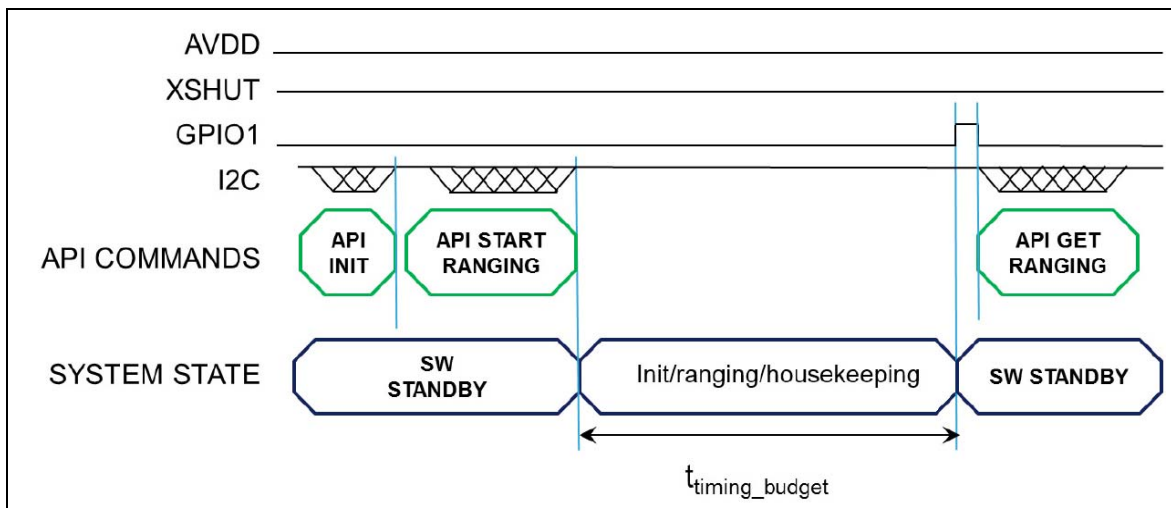

t_{timing_budget} is a parameter set by the user, using a dedicated API function.
Default value is 33 ms.

3 Control interface

This section specifies the control interface. The I²C interface uses two signals: serial data line (SDA) and serial clock line (SCL). Each device connected to the bus is using a unique address and a simple master / slave relationships exists.

Both SDA and SCL lines are connected to a positive supply voltage using pull-up resistors located on the host. Lines are only actively driven low. A high condition occurs when lines are floating and the pull-up resistors pull lines up. When no data is transmitted both lines are high.

Clock signal (SCL) generation is performed by the master device. The master device initiates data transfer. The I²C bus on the VL53L0X has a maximum speed of 400 kbits/s and uses a device address of 0x52.

Figure 13. Data transfer protocol

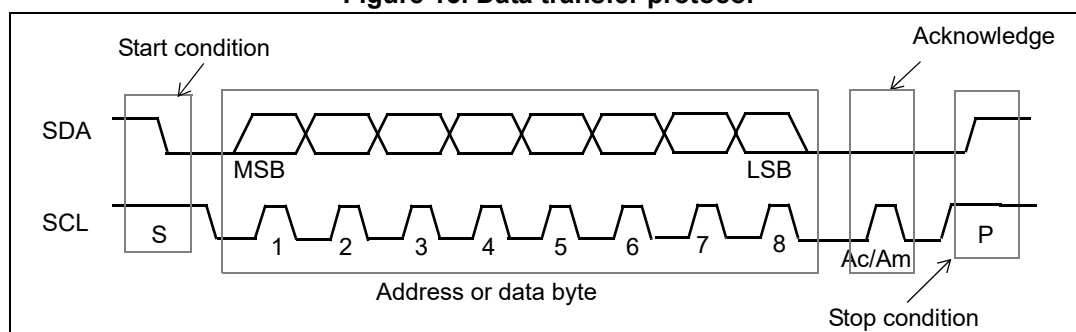

Information is packed in 8-bit packets (bytes) always followed by an acknowledge bit, Ac for VL53L0X acknowledge and Am for master acknowledge (host bus master). The internal data is produced by sampling SDA at a rising edge of SCL. The external data must be stable during the high period of SCL. The exceptions to this are start (S) or stop (P) conditions when SDA falls or rises respectively, while SCL is high.

A message contains a series of bytes preceded by a start condition and followed by either a stop or repeated start (another start condition but without a preceding stop condition) followed by another message. The first byte contains the device address (0x52) and also specifies the data direction. If the least significant bit is low (that is, 0x52) the message is a master write to the slave. If the lsb is set (that is, 0x53) then the message is a master read from the slave.

Figure 14. VL53L0X I2C device address: 0x52

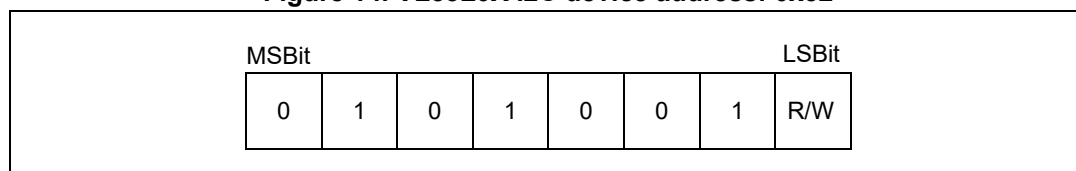

All serial interface communications with the Time-of-Flight sensor must begin with a start condition. The VL53L0X module acknowledges the receipt of a valid address by driving the SDA wire low. The state of the read/write bit (lsb of the address byte) is stored and the next byte of data, sampled from SDA, can be interpreted. During a write sequence the second byte received provide a 8-bit index which points to one of the internal 8-bit registers.

Figure 15. VL53L0X data format (write)

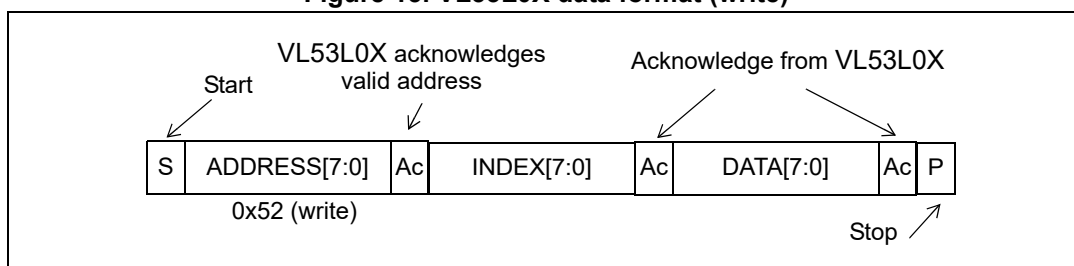

As data is received by the slave it is written bit by bit to a serial/parallel register. After each data byte has been received by the slave, an acknowledge is generated, the data is then stored in the internal register addressed by the current index.

During a read message, the contents of the register addressed by the current index is read out in the byte following the device address byte. The contents of this register are parallel loaded into the serial/parallel register and clocked out of the device by the falling edge of SCL.

Figure 16. VL53L0X data format (read)

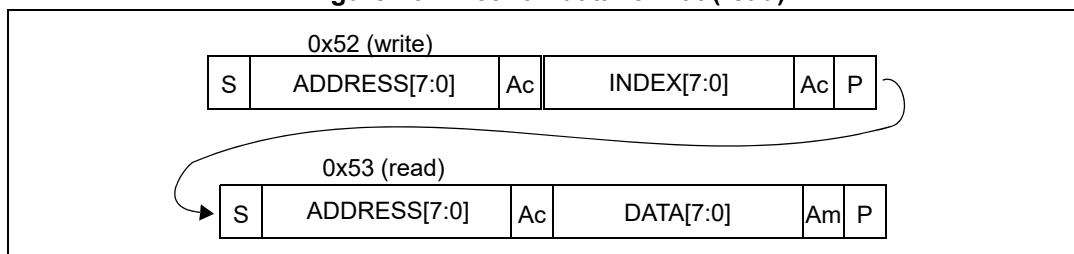

At the end of each byte, in both read and write message sequences, an acknowledge is issued by the receiving device (that is, the VL53L0X for a write and the host for a read).

A message can only be terminated by the bus master, either by issuing a stop condition or by a negative acknowledge (that is, **not** pulling the SDA line low) after reading a complete byte during a read operation.

The interface also supports auto-increment indexing. After the first data byte has been transferred, the index is automatically incremented by 1. The master can therefore send data bytes continuously to the slave until the slave fails to provide an acknowledge or the master terminates the write communication with a stop condition. If the auto-increment feature is used the master does **not** have to send address indexes to accompany the data bytes.

Figure 17. VL53L0X data format (sequential write)

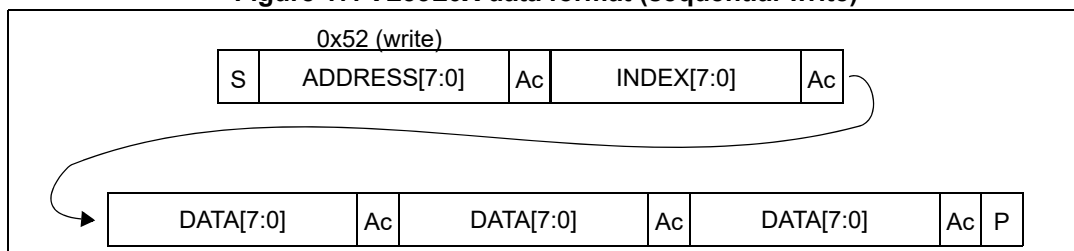
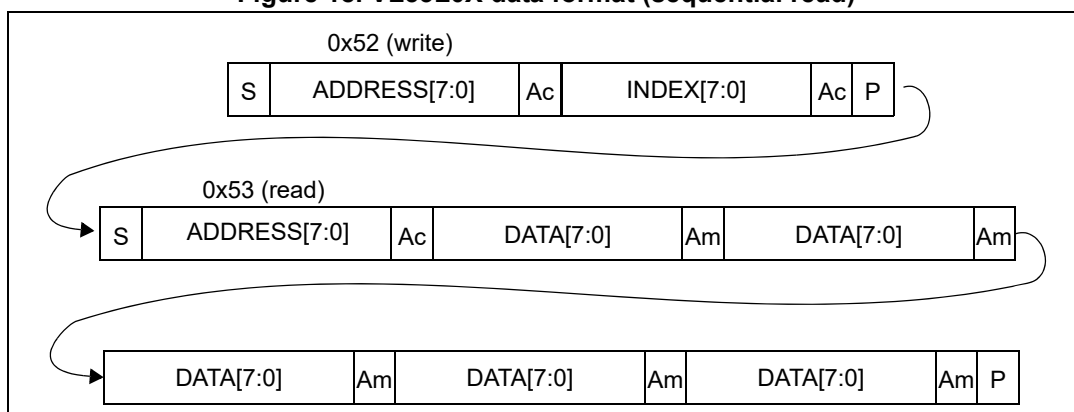

Figure 18. VL53L0X data format (sequential read)



3.1 I²C interface - timing characteristics

Timing characteristics are shown in [Table 3](#). Please refer to [Figure 19](#) for an explanation of the parameters used.

Timings are given for all PVT conditions.

Table 3. I²C interface - timing characteristics

Symbol	Parameter	Minimum	Typical	Maximum	Unit
F _{I2C}	Operating frequency (Standard and Fast mode)	0	-	400 ⁽¹⁾	kHz
t _{LOW}	Clock pulse width low	1.3	-	-	μs
t _{HIGH}	Clock pulse width high	0.6	-	-	μs
t _{SP}	Pulse width of spikes which are suppressed by the input filter	-	-	50	ns
t _{BUF}	Bus free time between transmissions	1.3	-	-	ms
t _{HD.STA}	Start hold time	0.26	-	-	μs
t _{SU.STA}	Start set-up time	0.26	-	-	μs
t _{HD.DAT}	Data in hold time	0	-	0.9	μs
t _{SU.DAT}	Data in set-up time	50	-	-	ns
t _R	SCL/SDA rise time	-	-	120	ns
t _F	SCL/SDA fall time	-	-	120	ns
t _{SU.STO}	Stop set-up time	0.6	-	-	μs
C _{i/o}	Input/output capacitance (SDA)	-	-	10	pF
C _{in}	Input capacitance (SCL)	-	-	4	pF
C _L	Load capacitance	-	125	400	pF

1. The maximum bus speed is also limited by the combination of 400 pF load capacitance and pull-up resistor. Please refer to the I²C specification for further information.

Figure 19. I²C timing characteristics

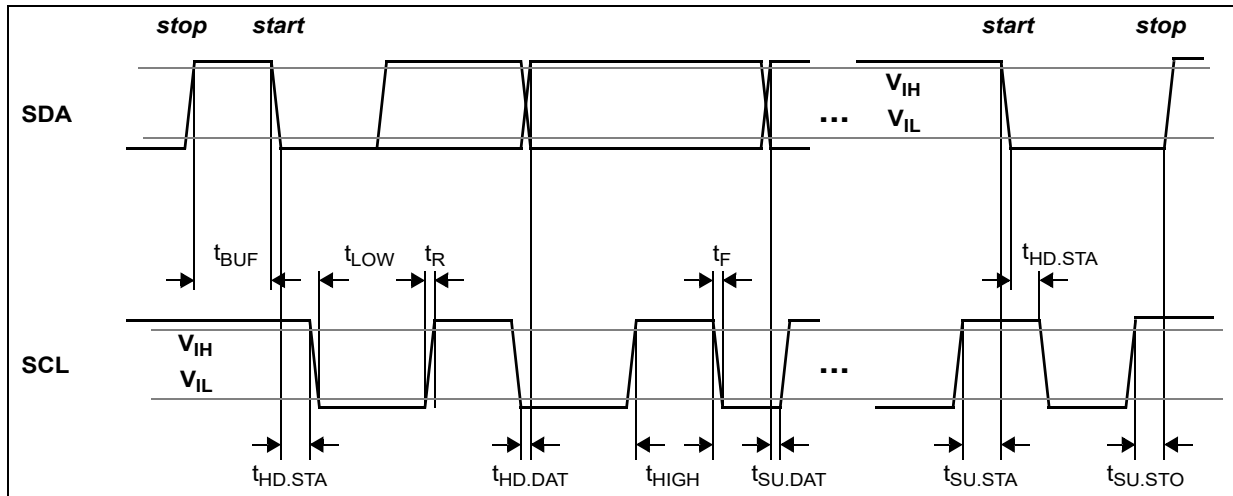

All timings are measured from either V_{IL} or V_{IH} .

3.2 I²C interface - reference registers

The registers shown in the table below can be used to validate the user I²C interface.

Table 4. Reference registers

Address	(After fresh reset, without API loaded)
0xC0	0xEE
0xC1	0xAA
0xC2	0x10
0x51	0x0099
0x61	0x0000

Note: I²C read/writes can be 8, 16 or 32-bit. Multi-byte reads/writes are always addressed in ascending order with MSB first as shown in Table 5.

Table 5. 32-bit register example

Register address	Byte
Address	MSB
Address + 1	..
Address + 2	..
Address + 3	LSB

4 Electrical characteristics

4.1 Absolute maximum ratings

Table 6. Absolute maximum ratings

Parameter	Min.	Typ.	Max.	Unit
AVDD	-0.5	-	3.6	V
SCL, SDA, XSHUT and GPIO1	-0.5	-	3.6	V

Note: Stresses above those listed in [Table 6](#). may cause permanent damage to the device. This is a stress rating only and functional operation of the device at these or any other conditions above those indicated in the operational sections of the specification is not implied. Exposure to absolute maximum rating conditions for extended periods may affect device reliability.

4.2 Recommended operating conditions

Table 7. Recommended operating conditions⁽¹⁾

Parameter	Min.	Typ.	Max.	Unit	
Voltage (AVDD)	2.6	2.8	3.5	V	
IO (IOVDD) ⁽²⁾	Standard mode	1.6	1.8	1.9	V
	2V8 mode ⁽³⁾⁽⁴⁾	2.6	2.8	3.5	V
Temperature (normal operating)	-20		+70	°C	

- There are no power supply sequencing requirements. The I/Os may be high, low or floating when AVDD is applied. The I/Os are internally failsafe with no diode connecting them to AVDD
- XSHUT should be high level only when AVDD is on.
- SDA, SCL, XSHUT and GPIO1 high levels have to be equal to AVDD in 2V8 mode.
- The default API mode is 1V8. 2V8 mode is programmable using device settings loaded by the API. For more details refer to the VL53L0X API User Manual.

4.3 ESD

VL53L0X is compliant with ESD values presented in [Table 8](#)

Table 8. ESD performances

Parameter	Specification	Conditions
Human Body Model	JS-001-2012	+/- 2 kV, 1500 Ohms, 100 pF
Charged Device Model	JZSD22-C101	+/- 500 V

4.4 Current consumption

Table 9. Consumption at ambient temperature⁽¹⁾

Parameter	Min.	Typ.	Max.	Unit
HW STANDBY	3	5	7	uA
SW STANDBY (2V8 mode) ⁽²⁾	4	6	9	uA
Timed ranging Inter measurement		16		uA
Active Ranging average consumption (including VCSEL) ⁽³⁾⁽⁴⁾		19		mA
Average power consumption at 10Hz with 33ms ranging sequence			20	mW

1. All current consumption values include silicon process variations. Temperature and Voltage are at nominal conditions (23degC and 2.8V).
All values include AVDD and AVDDVCSEL.
2. In standard mode (1V8), pull-ups have to be modified, then SW STANDBY consumption is increased by +0.6uA.
3. Active ranging is an average value, measured using default API settings (33ms timing budget).
4. Peak current (including VCSEL) can reach 40mA.

4.5 Electrical characteristics

Table 10. Digital I/O electrical characteristics

Symbol	Parameter	Minimum	Typical	Maximum	Unit
Interrupt pin (GPIO1)					
V_{IL}	Low level input voltage	-	-	0.3 IOVDD	V
V_{IH}	High level input voltage	0.7 IOVDD	-	-	V
V_{OL}	Low level output voltage ($I_{OUT} = 4$ mA)	-	-	0.4	V
V_{OH}	High level output voltage at ($I_{OUT} = 4$ mA)	IOVDD- 0.4	-	-	V
F_{GPIO}	Operating frequency ($C_{LOAD} = 20$ pF)	0	-	108	MHz
I²C interface (SDA/SCL)					
V_{IL}	Low level input voltage	-0.5	-	0.6	V
V_{IH}	High level input voltage	1.12	-	IOVDD+0.5	V
V_{OL}	Low level output voltage ($I_{OUT} = 4$ mA in Standard and Fast modes)	-	-	0.4	V
I_{IL}/I_H	Leakage current ⁽¹⁾	-	-	10	μA
	Leakage current ⁽²⁾	-	-	0.15	μA

1. AVDD = 0 V

2. AVDD = 2.85 V; I/O voltage = 1.8 V

5 Performance

5.1 Measurement conditions

In all measurement tables in the document, it is considered that the full field of view (FoV) is covered.

VL53L0X system FOV is 25degrees.

Reflectance targets are standard ones (Grey 17% N4.74 and White 88% N9.5 Munsell charts).

Unless mentioned, device is controlled through the API using the default settings (refer to VL53L0X API User Manual for API settings description).

Figure 20. Typical ranging (default mode)

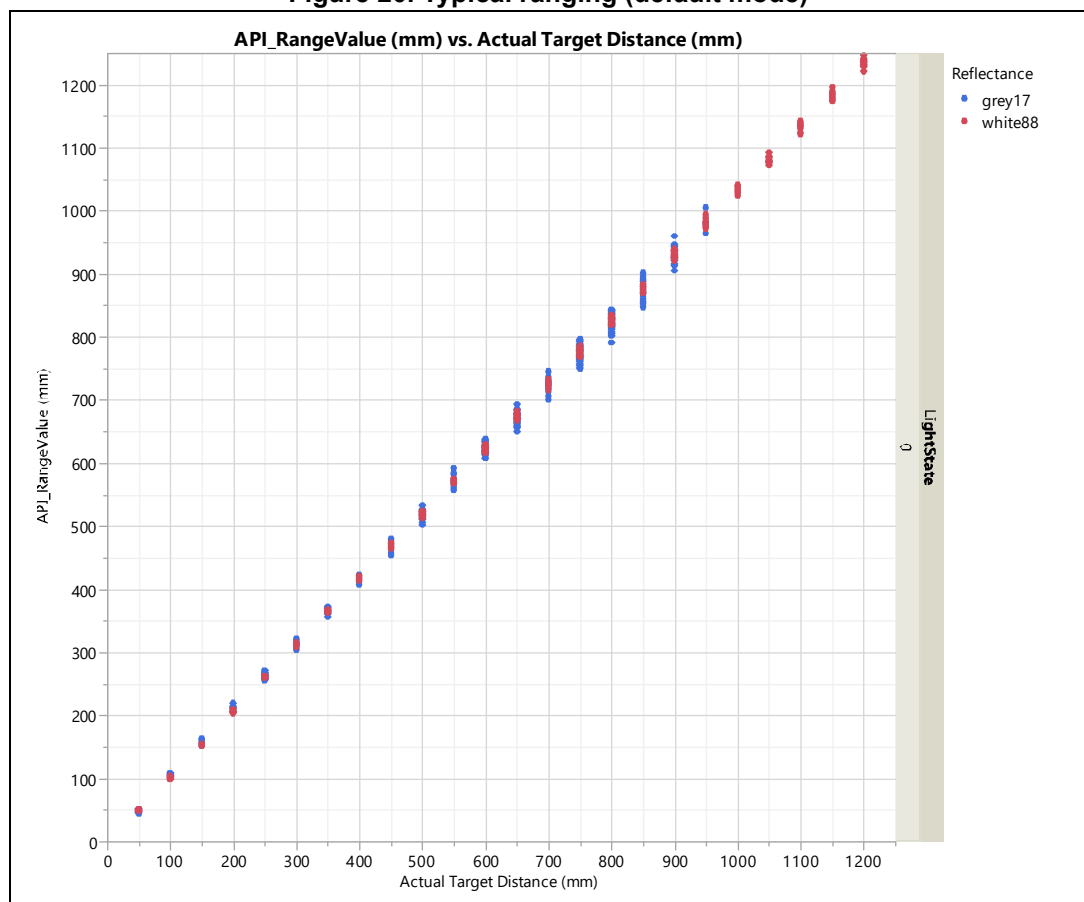
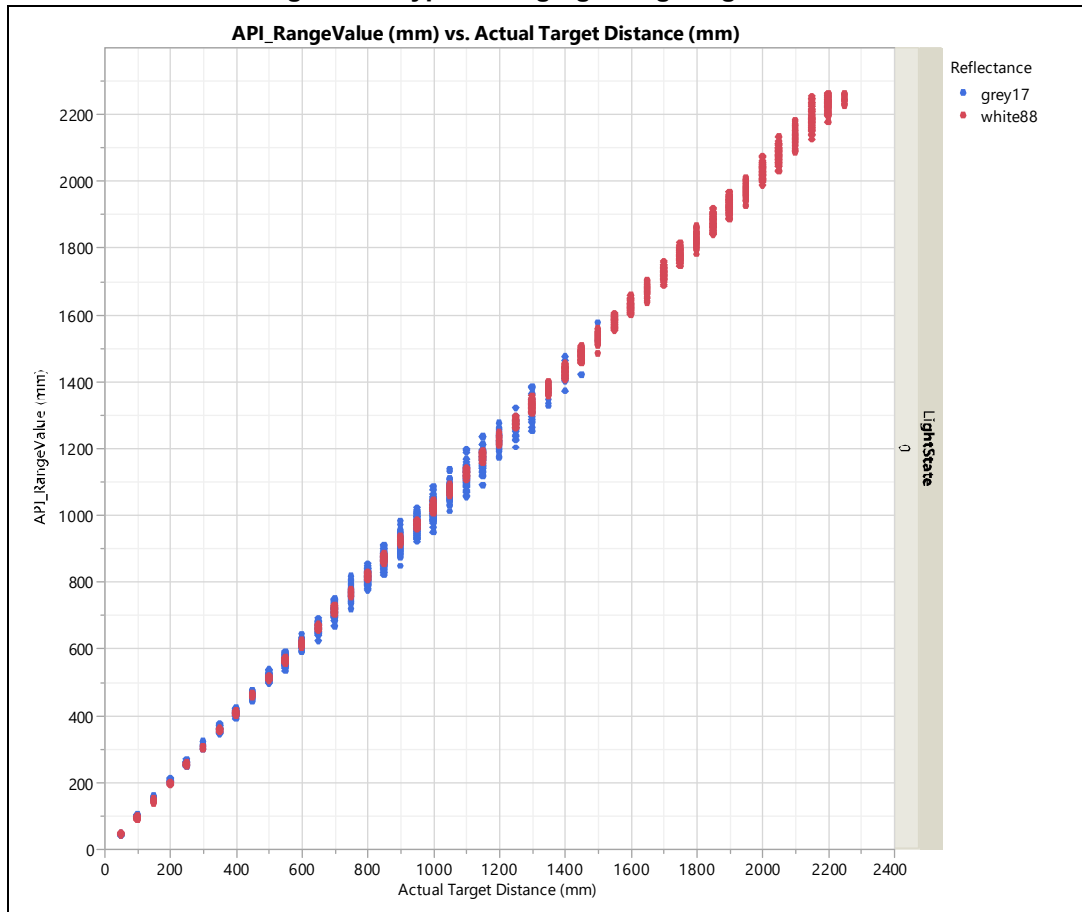

Figure 21. Typical ranging - long range mode



5.2 Max ranging distance

Table 11 presents the ranging specification for VL53L0X bare module, without cover glass, at room temperature (23degreesC) and with nominal voltage (2.8Volts).

Table 11. Max ranging capabilities with 33ms timing budget

Target reflectance level (full FOV)	Conditions	Indoor (2)	Outdoor overcast (2)
White target (88%)	Typical	200cm+ (1)	80 cm
	Minimum	120 cm	60 cm
Grey target (17%)	Typical	80 cm	50 cm
	Minimum	70 cm	40 cm

Note (1): using long range API profile

Note (2):

- Indoor: no infrared
- Outdoor overcast corresponds to a parasitic noise of 10 kcps/SPAD for VL53L0X module. For reference, this corresponds to a 1.2W/m² at 940 nm, and is equivalent to 5kLux daylight, while ranging on a grey 17% chart at 40 cm

Measurement conditions:

- Targets reflectance used : Grey (17%), White (88%)
- Nominal Voltage (2.8V) and Temperature (23degreesC)
- All distances are for a complete Field of View covered (FoV = 25degrees)
- 33ms timing budget

All distances mentioned in this table are guaranteed for a minimum detection rate of 94% (up to 100%). Detection rate is the worst case percentage of measurements that will return a valid measurement when target is detected.

5.3 Ranging accuracy

5.3.1 Standard deviation

Ranging accuracy can be characterized by standard deviation. It includes Measure-to-Measure and Part-to-Part (silicon) dispersion.

Table 12. Ranging accuracy

Target reflectance level (full FOV)	Indoor (no infrared)			Outdoor		
	Distance	33 ms	66 ms	Distance	33 ms	66 ms
White Target (88%)	At 120 cm	4%	3%	At 60 cm	7%	6%
Grey Target (17%)	At 70 cm	7%	6%	at 40 cm	12%	9%

Measurement conditions:

- Targets reflectance used: Grey (17%), White (88%)
- Offset correction done at 10 cm from sensor
- Indoor: no infrared / Outdoor: eq. 5 kLux equivalent sunlight (10 kcps/SPAD)
- Nominal voltage (2v8) and temperature (23 degreesC)
- All distances are for a complete FoV covered (FOV = 25 degrees)
- Detection rate is considered at 94% minimum

5.3.2 Range profile examples

Table 13 details typical performance for the four example ranging profiles, as per measurement conditions in Section 5.3: Ranging accuracy.

Table 13. Range profiles

Range profile	Range timing budget	Typical performance	Typical application
Default mode	30 ms	1.2 m, accuracy as per Table 12	Standard
High accuracy	200 ms	1.2 m, accuracy < +/- 3%	Precise measurement
Long range	33 ms	2 m, accuracy as per Table 12	Long ranging, only for dark conditions (no IR)
High speed	20 ms	1.2 m, accuracy +/- 5%	High speed where accuracy is not priority

5.3.3 Ranging offset error

The table below shows how range offset may drift over distance, voltage and temperature. Assumes offset calibrated at 10 cm. See VL53L0X API User Manual for details on offset calibration.

Table 14. Ranging offset

	Nominal conditions	Measure point	Typical offset from nominal	Maximum offset from nominal
Ranging distance	Offset calibration at 10 cm ("zero")	White 120 cm (indoor) Grey 70 cm (indoor) White 60 cm (outdoor) Grey 40 cm (outdoor)		< 3%
Voltage drift	2.8 V	2.6 V to 3.5 V	+/- 10 mm	+/- 15 mm
Temperature drift	23°C	-20°C to +70°C	+/- 10 mm	+/- 30 mm

6 Outline drawing

Figure 22. Outline drawing (page 1/3)

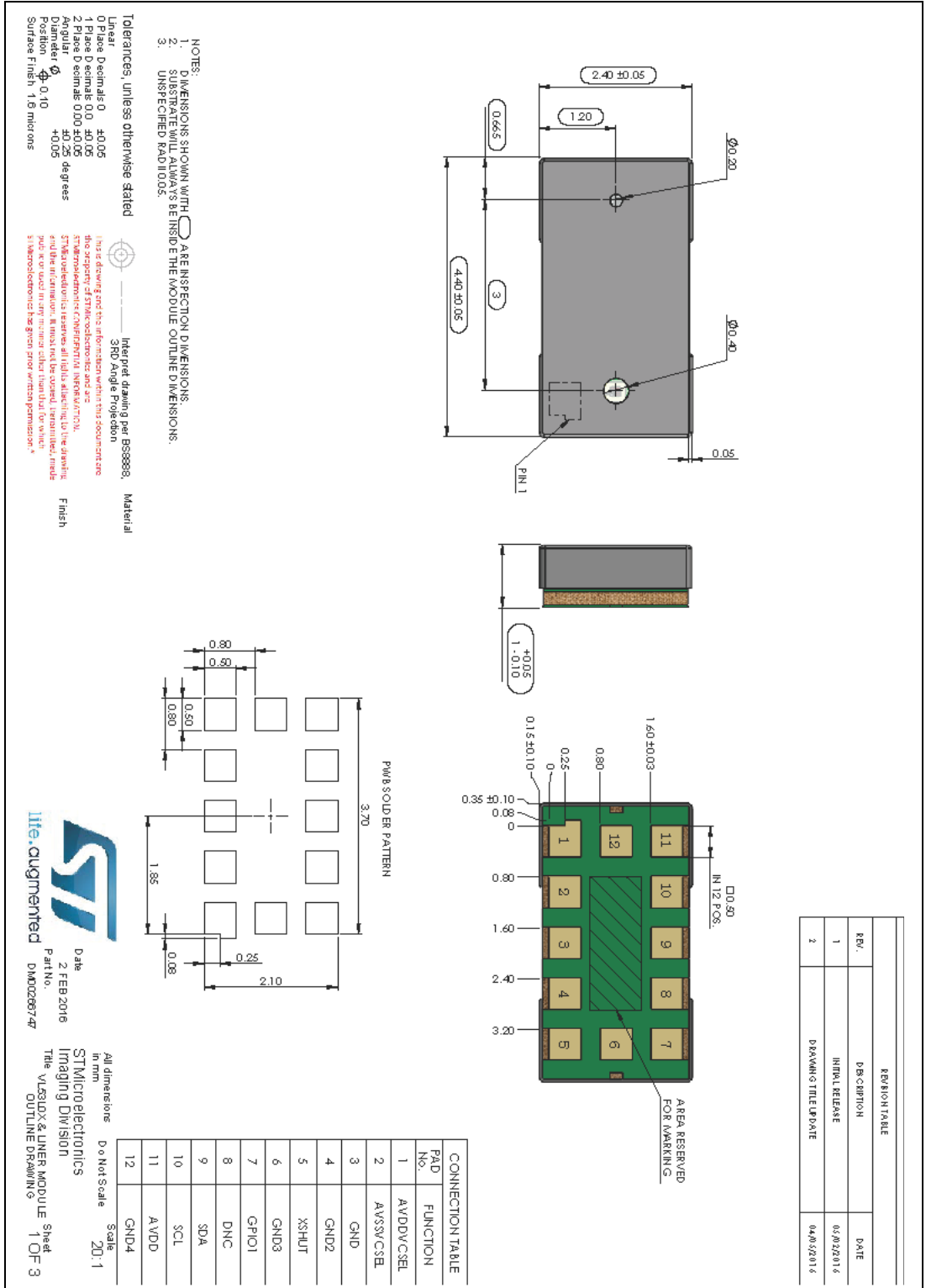
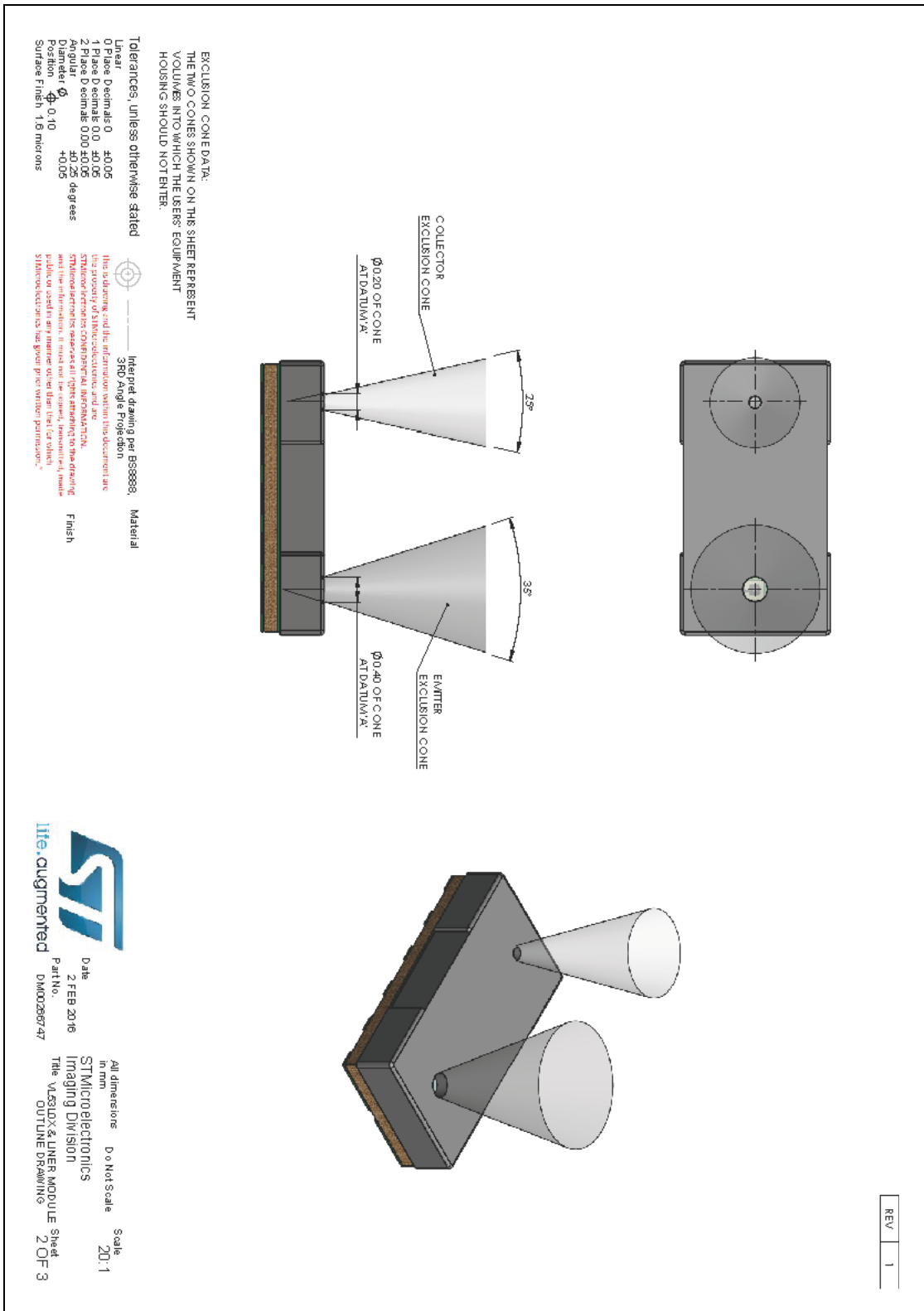

Figure 23. Outline drawing (page 2/3)



7 Laser safety considerations

The VL53L0X contains a laser emitter and corresponding drive circuitry. The laser output is designed to remain within Class 1 laser safety limits under all reasonably foreseeable conditions including single faults in compliance with IEC 60825-1:2014 (third edition).

The laser output will remain within Class 1 limits as long as the STMicroelectronics recommended device settings (API settings) are used and the operating conditions specified are respected.

The laser output power must not be increased by any means and no optics should be used with the intention of focusing the laser beam.

Caution: Use of controls or adjustments or performance of procedures other than those specified herein may result in hazardous radiation exposure.

Figure 25. Class 1 laser product label



8 Packaging and labeling

8.1 Product marking

A 2-line product marking is applied on the backside of the module (i.e. on the substrate). The first line is the silicon product code, and the second line, the internal tracking code.

Figure 26. Example of marking

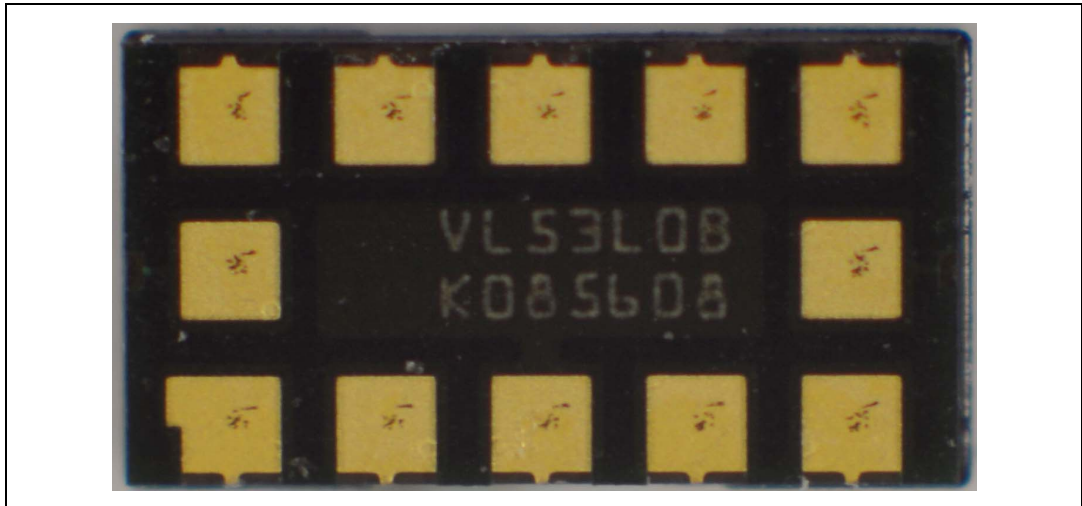

8.2 Inner box labeling

The labeling follows the ST standard packing acceptance specification.

The following information will be on the inner box label:

- assembly site
- sales type
- quantity
- trace code
- marking
- bulk ID number

8.3 Packing

At customer / subcontractor level, it is recommended to mount the VL53L0X in a clean environment to avoid foreign material deposition.

To help avoid any foreign material contamination at phone assembly level the modules will be shipped in a tape and reel format with a protective liner. The packaging will be vacuum-sealed and include a desiccant.

The liner is compliant with reflow at 260°C. It must be removed during assembly of the customer device, just before mounting the cover glass.

8.3.1 Tape outline drawings

Figure 27. Tape outline drawing

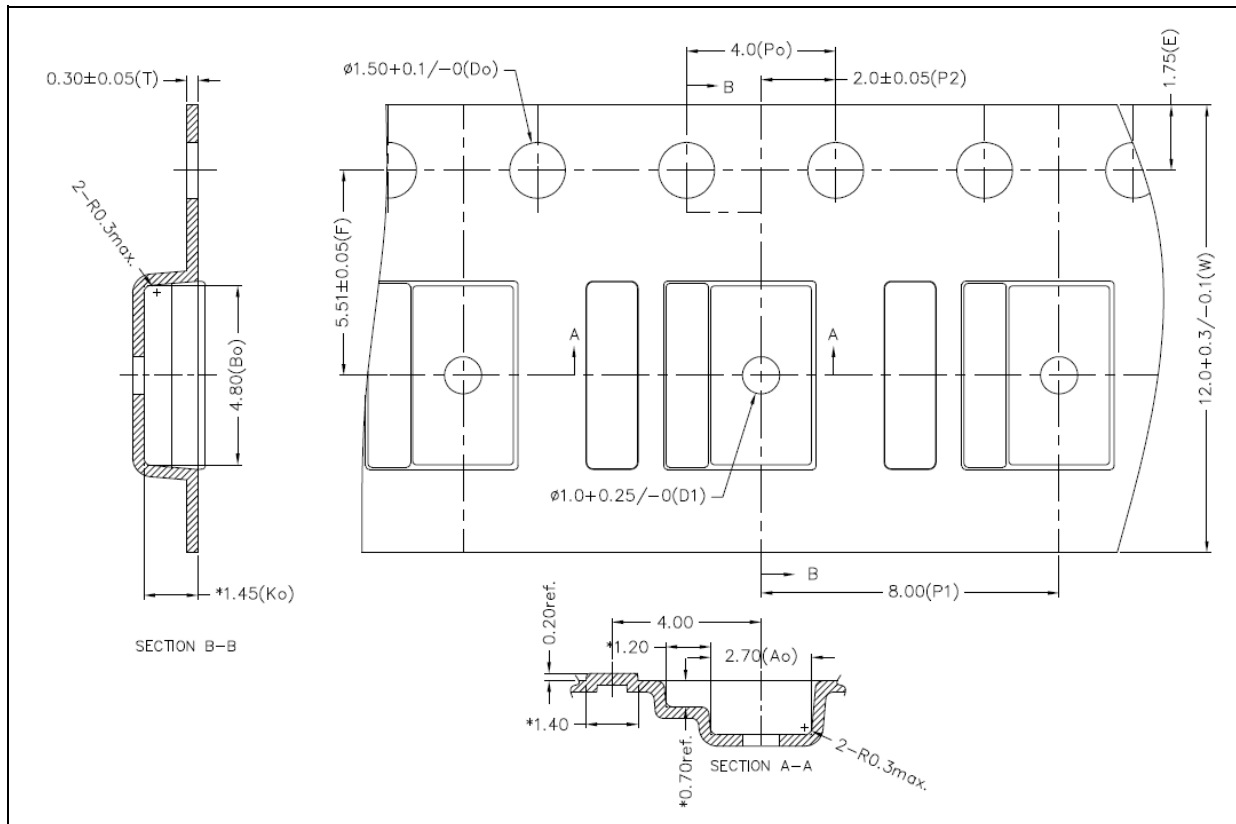

8.4 Pb-free solder reflow process

Figure 28 and Table 15 shows the recommended and maximum values for the solder profile.

Customers will have to tune the reflow profile depending on the PCB, solder paste and material used.

We expect customers to follow the “recommended” reflow profile, which is specifically tuned for VL53L0X package.

For any reason if a customer must perform a reflow profile which is different from “recommended” one (especially peak $>240^{\circ}C$), this new profile must be qualified by the customer at its own risk. In any case, the profile have to be within the “maximum” profile limit described in Table 15.

Table 15. Recommended solder profile

Parameters	Recommended	Maximum	Units
Minimum temperature (T_S min)	130	150	°C
Maximum temperature (T_S max)	200	200	°C
Time t_s (T_S min to T_S max)	90-110	60 - 120	seconds
Temperature (T_L)	217	217	°C
Time (t_L)	55-65	55 - 65	seconds
Ramp up	+2	+3	°C/second
Temperature (T_{p-10})	-	250	°C
Time (t_{p-10})	-	10	seconds
Ramp up	-	+3	°C/second
Peak temperature (T_p)	240	260 max	°C
Time to peak	300	300	seconds
Ramp down (peak to T_L)	-4	-6	°C/second

Figure 28. Solder profile

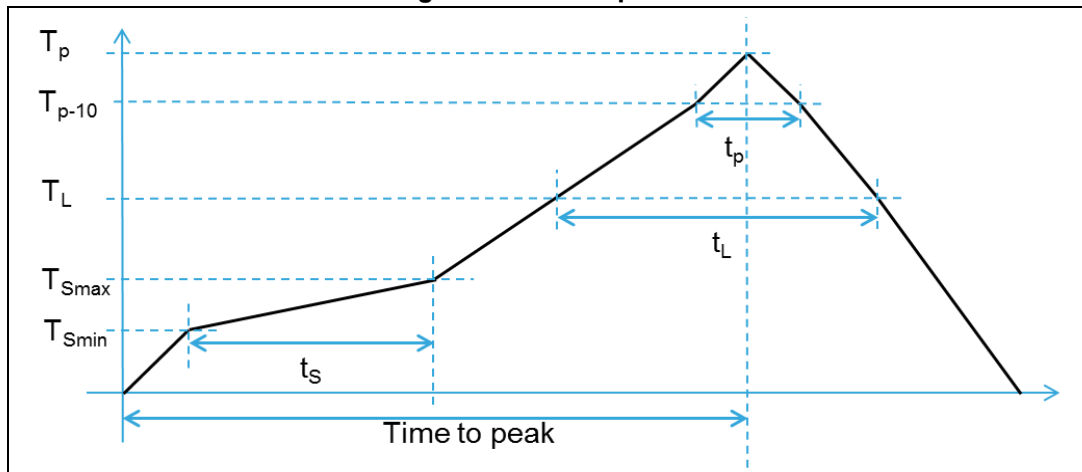

Note: Temperature mentioned in Table 15 is measured at the top of VL53L0X package.

Note: The component should be limited to a maximum of 3 passes through this solder profile.

Note: As the VL53L0X package is not sealed, only a dry reflow process should be used (such as convection reflow). Vapor phase reflow is not suitable for the VL53L0X because it is an optical component. Consequently, the VL53L0X should be treated carefully. This would typically include using a 'no-wash' assembly process.

8.5 Handling and storage precautions

8.5.1 Shock precaution

Proximity sensor modules house numerous internal components that are susceptible to shock damage. If a unit is subject to excessive shock, is dropped onto the floor, or a tray/reel of units is dropped onto the floor, it must be rejected, even if no apparent damage is visible.

8.5.2 Part handling

Handling must be done with non-marring ESD safe carbon, plastic, or Teflon tweezers. Ranging module are susceptible to damage or contamination. A clean assembly process is advised at customer after un-taping the parts, and until a protective cover glass is mounted.

8.5.3 Compression force

A maximum compressive load of 25N shall be applied on the module.

8.5.4 Moisture sensitivity level

Moisture sensitivity is level 3 (MSL) as described in IPC/JEDEC JSTD-020-C.

8.6 Storage temperature conditions

Table 16. Recommended storage conditions

Parameter	Min.	Typ.	Max.	Unit
Temperature (storage)	-40		+85	°C

9 Ordering information

Table 17. Ordering information

Sales type	Package	Packing
VL53L0CXV0DH/1	Optical LGA12 with liner	Tape and reel

10 Acronyms and abbreviations

Table 18. Acronyms and abbreviations

Acronym/ abbreviation	Definition
ESD	Electrostatic discharge
I ² C	Inter-integrated circuit (serial bus)
NVM	Non volatile memory
RIT	Return Ignore Threshold
SPAD	Single photon avalanche diode
VCSEL	Vertical cavity surface emitting laser

11 ECOPACK

In order to meet environmental requirements, ST offers these devices in different grades of ECOPACK packages, depending on their level of environmental compliance. ECOPACK specifications, grade definitions and product status are available at: www.st.com. ECOPACK is an ST trademark.

12 Revision history

Table 19. Document revision history

Date	Revision	Changes
30-May-2016	1.0	Initial release.
09-Apr-2018	2	Updated title Updated Features Small text changes to Description Removed note from Section 2.6.2: Ranging phase Added text before Figure 24, Section 6: Outline drawing
12-Oct-2021	3	Section 3: Control interface : replaced “camera module” with “Time-of-Flight” sensor.
29-Nov-2022	4	Updated Figure 22: Outline drawing (page 1/3) , Figure 23: Outline drawing (page 2/3) , and Figure 24: Outline drawing - with liner (page 3/3) Added a note before Figure 24: Outline drawing - with liner (page 3/3) Updated Figure 27: Tape outline drawing
08-Dec-2022	5	Updated document title Updated Applications Removed “new generation” from Description

IMPORTANT NOTICE – READ CAREFULLY

STMicroelectronics NV and its subsidiaries (“ST”) reserve the right to make changes, corrections, enhancements, modifications, and improvements to ST products and/or to this document at any time without notice. Purchasers should obtain the latest relevant information on ST products before placing orders. ST products are sold pursuant to ST’s terms and conditions of sale in place at the time of order acknowledgment.

Purchasers are solely responsible for the choice, selection, and use of ST products and ST assumes no liability for application assistance or the design of purchasers’ products.

No license, express or implied, to any intellectual property right is granted by ST herein.

Resale of ST products with provisions different from the information set forth herein shall void any warranty granted by ST for such product.

ST and the ST logo are trademarks of ST. For additional information about ST trademarks, refer to www.st.com/trademarks. All other product or service names are the property of their respective owners.

Information in this document supersedes and replaces information previously supplied in any prior versions of this document.

© 2022 STMicroelectronics – All rights reserved

单击下面可查看定价，库存，交付和生命周期等信息

[>>STMicro\(意法半导体\)](#)