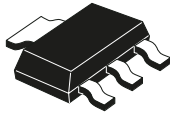


1.2 A high PSRR low-dropout linear voltage regulator



SOT223

Features

- Input voltage from 2.5 V to 18 V
- 20 V AMR
- Available on fixed output voltages: 1.2 V (1.185 V), 1.5 V, 1.8 V, 2.5 V, 3 V, 3.3 V, 5.0 V (other options are available on request)
- Guaranteed output current 1.2 A
- Typical dropout 350 mV @ 1.2 A
- Internal thermal, current and power limitation
- High PSRR 87 dB @ 120 Hz
- Operating temperature range: -40 °C to 125°C
- Package SOT223

Applications

- Consumer
- Industrial
- SMPS
- Motherboard P.O.L.
- DC-DC post-regulation

Description

The **LDL1117** provides 1.2 A of maximum current with an input voltage range from 2.5 V to 18 V, and a typical dropout voltage of 350 mV @ 1.2 A.

The high power supply rejection ratio of 87 dB at 120 Hz, rolling down to more than 40 dB at 100 kHz, makes the **LDL1117** suitable for direct regulations in SMPS and secondary linear regulations in DC-DC converters.

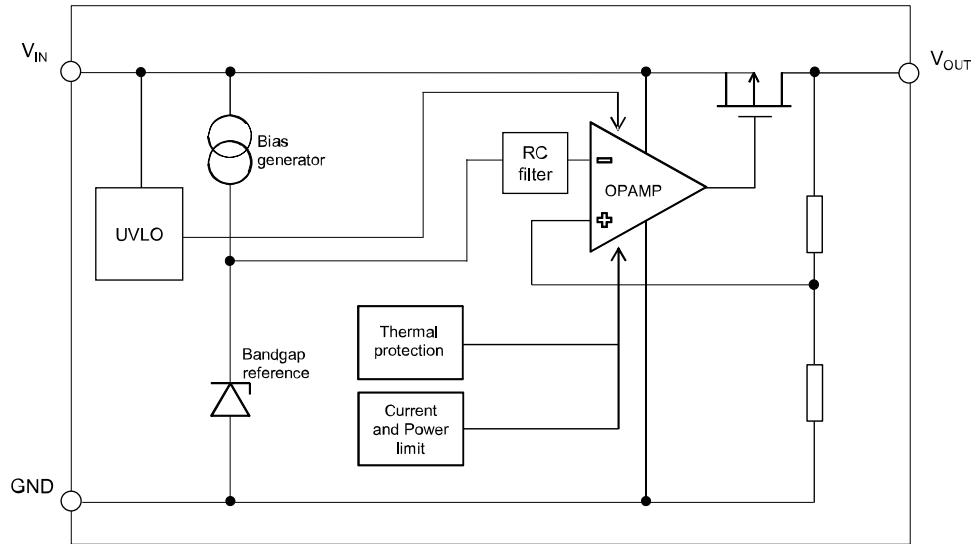
This device includes current limit, SOA and thermal protections.

Maturity status link

[LDL1117](#)

1 Diagram

Figure 1. Block diagram



2 Pin configuration

Figure 2. Pin connection (top view)

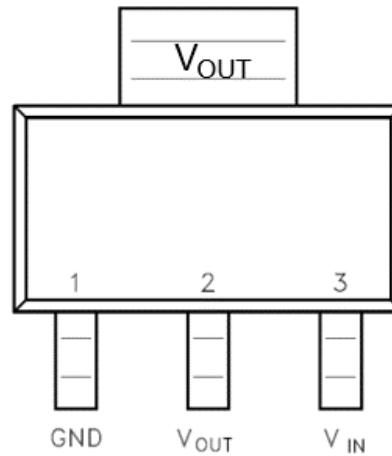


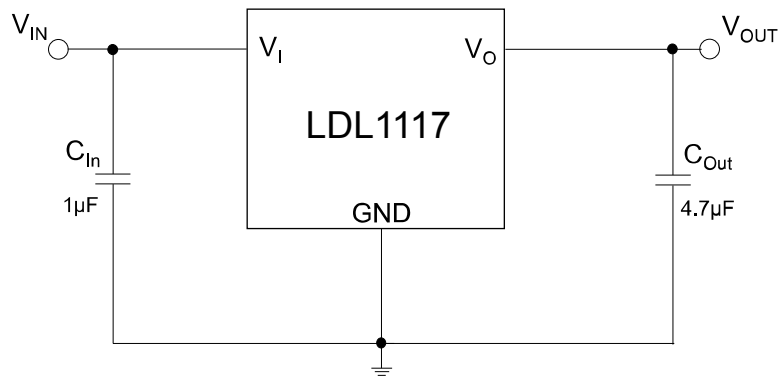
Table 1. Pin description

Pin name	Pin number	Description
GND	1	Ground
V _{OUT}	2	Output voltage
V _{IN}	3	Input voltage

Note: The tab is connected to V_{OUT}.

3 Typical application

Figure 3. Typical application diagram



4 Maximum ratings

Table 2. Absolute maximum ratings

Symbol	Parameter	Value	Unit
V_{IN}	Input supply voltage	-0.3 to 20	V
V_{OUT}	Output voltage	-0.3 to $V_{IN} + 0.3$	V
I_{OUT}	Output current	Internally limited	A
P_D	Power dissipation	Internally limited	W
T_{J-OP}	Operating junction temperature	- 40 to 125	°C
T_{J-MAX}	Maximum junction temperature	150	°C
T_{STG}	Storage temperature	- 55 to 150	°C

Note: Absolute maximum ratings are those values beyond which damage to the device may occur. Functional operation under these conditions is not implied.

Table 3. Thermal data

Symbol	Parameter	Value	Unit
θ_{J-C}	Thermal resistance junction-to-case	15	°C/W
θ_{J-A}	Thermal resistance junction-to-ambient	120	

5 Electrical characteristics

$T_J = 25\text{ °C}$, $V_{IN} = V_{OUT} + 1\text{ V}$ or 2.6 V , whichever is greater; $C_{IN} = 1\text{ }\mu\text{F}$; $C_{OUT} = 4.7\text{ }\mu\text{F}$; $I_{OUT} = 10\text{ mA}$.

Table 4. Electrical characteristics

Symbol	Parameter	Test conditions	Min.	Typ.	Max.	Unit
V_{IN}	Operating input voltage		2.6		18	V
V_{UVLO}	Turn-on threshold			2.3	2.4	V
	Hysteresis			200		mV
V_{OUT}	V_{OUT} accuracy	$I_{OUT} = 10\text{ mA}$, $T_J = 25\text{ °C}$	-2		+2	%
		$I_{OUT} = 10\text{ mA}$, $-40\text{ °C} < T_J < 125\text{ °C}$	-3		+3	%
ΔV_{OUT}	Line regulation	$V_{OUT} + 1\text{ V}^{(1)} \leq V_{IN} \leq 18\text{ V}$, $I_{OUT} = 10\text{ mA}$ $-40\text{ °C} < T_J < 125\text{ °C}$		0.002	0.02	%/V
ΔV_{OUT}	Load regulation	$I_{OUT} = 10\text{ mA}$ to 1.2 A , $-40\text{ °C} < T_J < 125\text{ °C}$		5	15	mV
V_{DROP}	Dropout voltage ⁽²⁾	$I_{OUT} = 1.2\text{ A}$, $V_{OUT} > 2.5\text{ V}$ $-40\text{ °C} < T_J < 125\text{ °C}$		350	600	mV
eN	Output noise voltage	10 Hz to 100 kHz, $I_{OUT} = 100\text{ mA}$		60		$\mu\text{V}_{RMS}/V_{OUT}$
SVR	Supply voltage rejection	$V_{IN} = V_{OUT(NOM)} + 1\text{ V} \pm V_{RIPPLE}$ $V_{RIPPLE} = 0.5\text{ V}$, $f = 120\text{ Hz}$		87		dB
		$V_{IN} = V_{OUT(NOM)} + 1\text{ V} \pm V_{RIPPLE}$ $V_{RIPPLE} = 0.5\text{ V}$, $f = 1\text{ kHz}$		80		
		$V_{IN} = V_{OUT(NOM)} + 1\text{ V} \pm V_{RIPPLE}$ $V_{RIPPLE} = 0.5\text{ V}$, $f = 100\text{ kHz}$		65		
I_Q	Quiescent current	$I_{OUT} = 0\text{ mA}$ to 1.2 A , $-40\text{ °C} < T_J < 125\text{ °C}$		250	500	μA
I_{SC}	Output current		1.5	2		A
T_{SHDN}	Thermal shutdown			175		$^{\circ}\text{C}$
	Hysteresis			25		

1. $V_{IN} = V_{OUT} + 1\text{ V}$ or 2.6 V , whichever is greater.

2. Dropout voltage is the input-to-output voltage difference at which the output voltage is 100 mV below its nominal value; this specification does not apply for nominal output voltages below 2.5 V.

6 Application information

6.1 Thermal and short-circuit protections

The LDL1117 is self-protected from short-circuit conditions and overtemperature. When the output load is higher than the one supported by the device, the output current rises until the limit of typically 2 A is reached. The current limit value is dependent of the dissipated power, thanks to an additional SOA protection, so that the maximum power is limited.

The peak current available for a defined drop voltage ($V_{IN}-V_{OUT}$) is shown in [Section 7](#).

The thermal protection occurs when the junction temperature reaches typically 175 °C. The IC enters the shutdown status. As soon as the junction temperature falls again below 150 °C (typ.) the device starts working again.

In order to calculate the maximum power that the device can dissipate, keeping the junction temperature below T_{J-OP} , the following formula is used:

$$P_{DMAX} = (125 - T_{AMB}) / R_{THJ} - A \quad (1)$$

P_{DMAX} should be also derated according to the maximum current allowed by the SOA protection.

6.2 Input and output capacitor selection

The LDL1117 requires external capacitors to assure the regulator control loop stability.

Any good quality ceramic capacitor can be used but, the X5R and the X7R are suggested since they guarantee a very stable combination of capacitance and ESR over the temperature range. The input/output capacitors should be placed as close as possible to the relative pins. The LDL1117 requires an input capacitor with a minimum value of 1 μ F.

The device is also equipped with a differential thermal protection that avoid damage in case of fast thermal gradients inside the chip. When the differential thermal protection is activated both channel and the LDO are switched off. This protection works in auto-retry mode, the device restarts automatically when the thermal conditions go back into the normal operating region.

This capacitor must be placed as close as possible to the input pin of the device and returned to a clean analog ground. The control loop of the LDL1117 is designed to work with an output ceramic capacitor. Other type of capacitors may be used, as long as they meet the requirements of minimum capacitance and equivalent series resistance (ESR), as shown in [Figure 20](#) and [Figure 21](#).

To assure stability, the output capacitor must maintain its ESR and capacitance in the stable region, over the full operating temperature range.

The suggested combination of 1 μ F input and 4.7 μ F output capacitors offers a good compromise among the stability of the regulator, optimum transient response and total PCB area occupation.

7 Typical characteristics

The following plots are referred to the typical application circuit and, unless otherwise noted, at $T_A = 25\text{ }^\circ\text{C}$.

Figure 4. Output voltage vs. temperature ($V_{IN} = 2.6\text{ V}$, $V_{OUT} = 1.2\text{ V}$, no load)

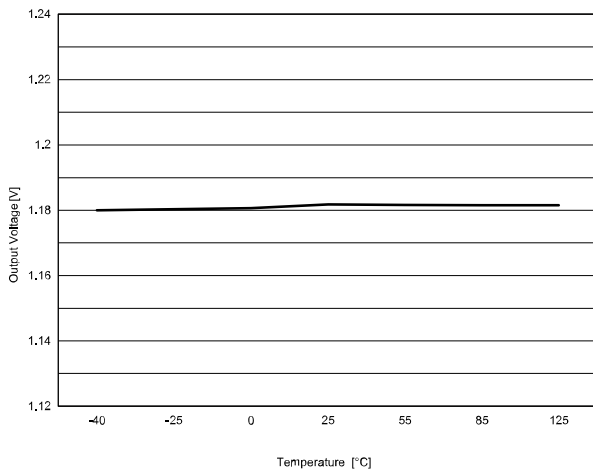


Figure 5. Output voltage vs. temperature ($V_{IN} = 2.6\text{ V}$, $V_{OUT} = 1.2\text{ V}$, 1200 mA)

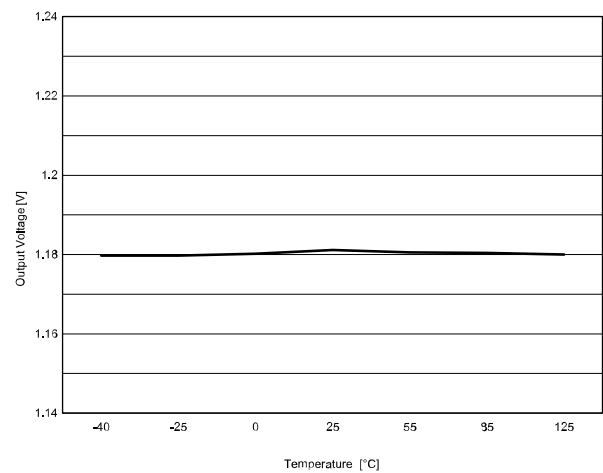


Figure 6. Output voltage vs. temperature ($V_{IN} = 6\text{ V}$, $V_{OUT} = 5\text{ V}$, no load)

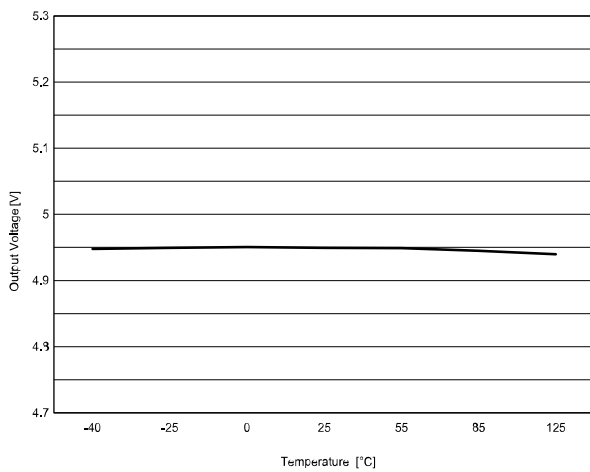


Figure 7. Output voltage vs. temperature ($V_{IN} = 6\text{ V}$, $V_{OUT} = 5\text{ V}$, 1200 mA)

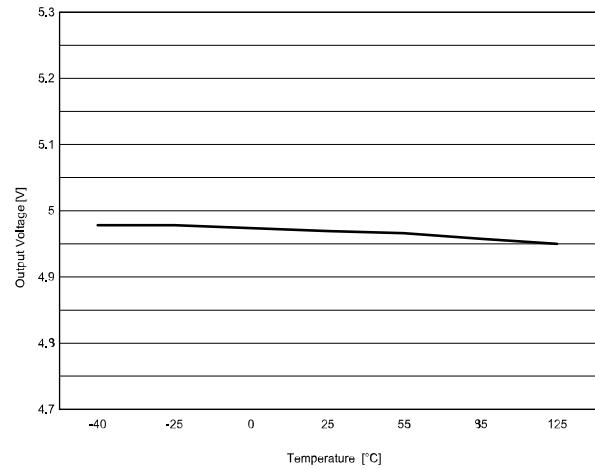


Figure 8. Line regulation vs. temperature ($V_{IN} = 6$ to 18 V, $V_{OUT} = 5$ V, $I_{OUT} = 10$ mA)

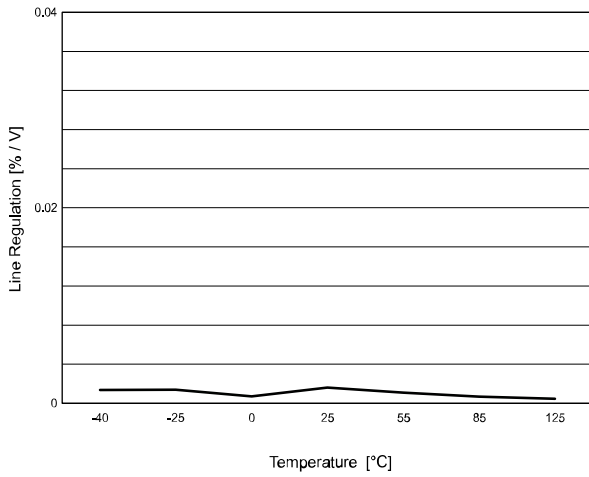


Figure 9. Line regulation vs. temperature ($V_{IN} = 2.5$ to 18 V, $V_{OUT} = 1.2$ V, $I_{OUT} = 10$ mA)

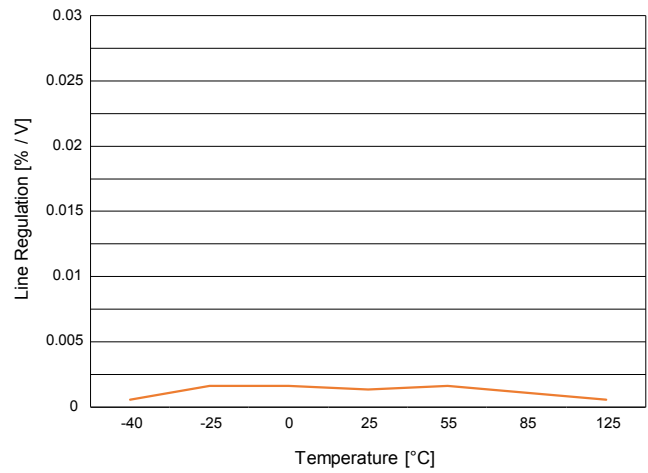


Figure 10. Load regulation vs. temperature ($V_{IN} = 6$ V, $V_{OUT} = 5$ V, $I_{OUT} = 10$ to 1200 mA)

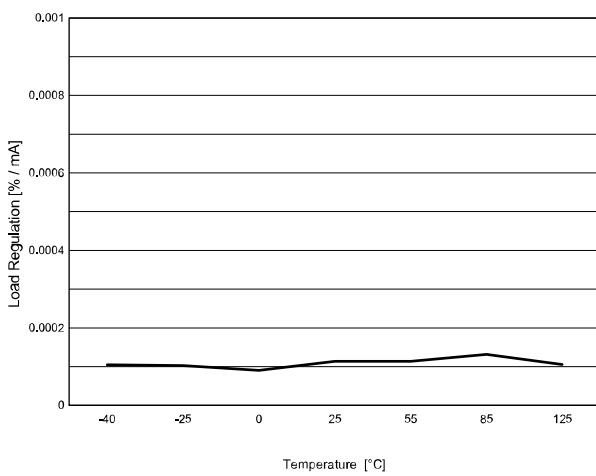


Figure 11. Load regulation vs. temperature ($V_{IN} = 2.6$ V, $V_{OUT} = 1.2$ V, $I_{OUT} = 10$ to 1200 mA)

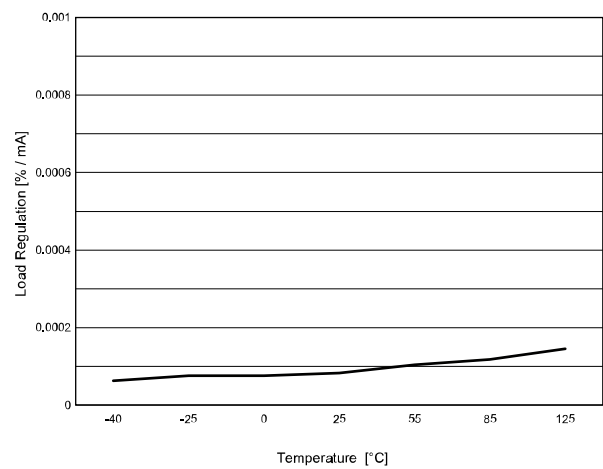


Figure 12. Dropout voltage vs. temperature

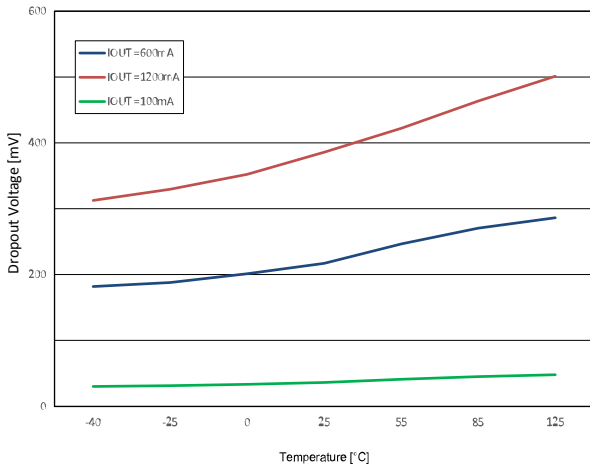


Figure 13. Quiescent current vs. temperature (no load)

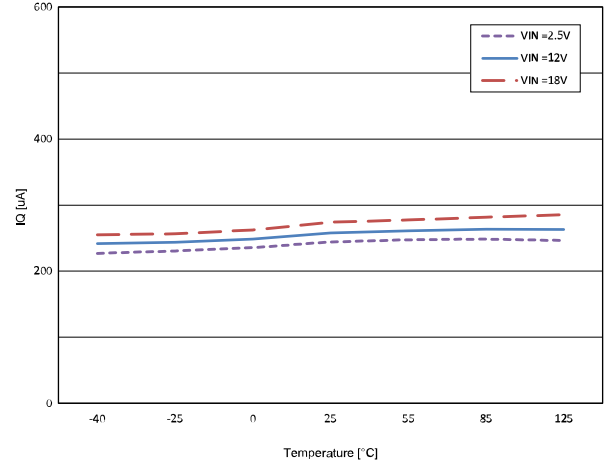


Figure 14. Quiescent current vs. temperature (600 mA)

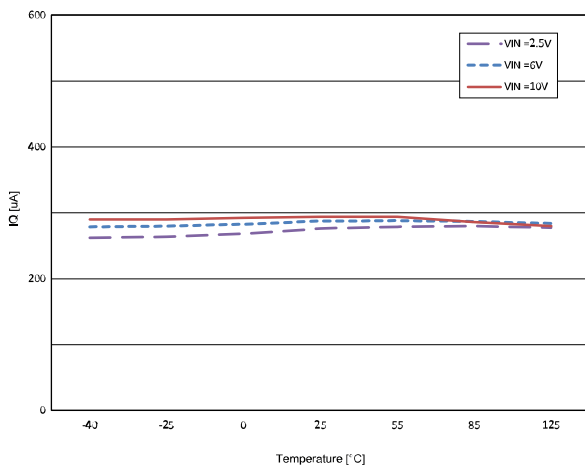


Figure 15. Quiescent current vs. temperature (1.2 A)

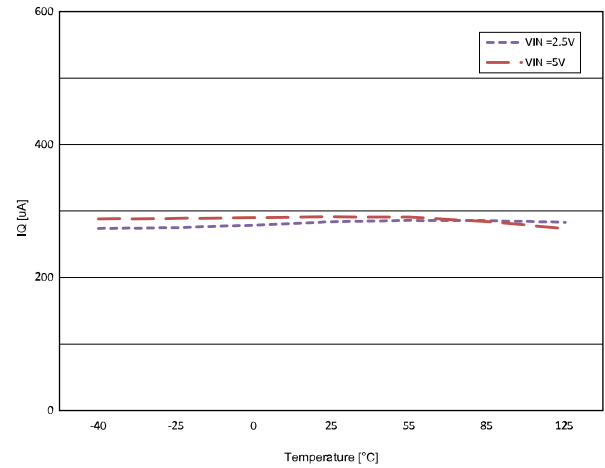


Figure 16. Short-circuit current vs. dropout voltage ($V_{OUT} = 5\text{ V}$)

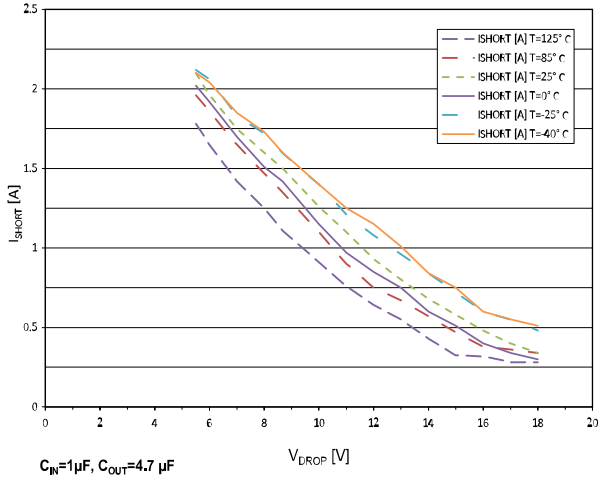


Figure 17. Short-circuit current vs. dropout voltage ($V_{OUT} = 1.2\text{ V}$)

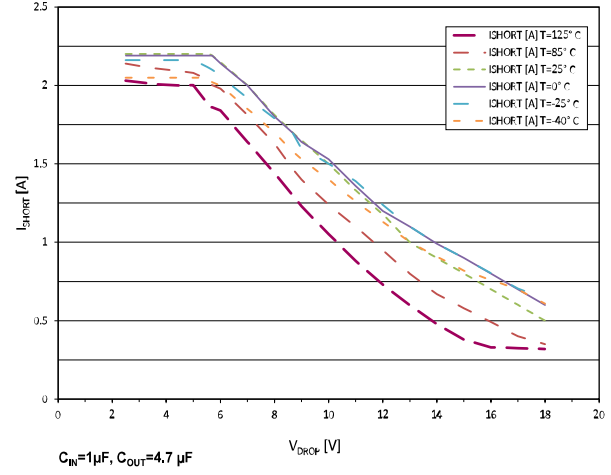


Figure 18. SVR vs. frequency

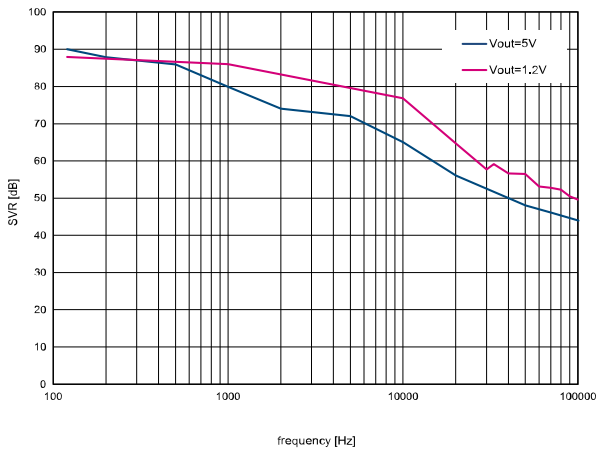


Figure 19. Output noise spectral density ($V_O = 1.2\text{ V}$)

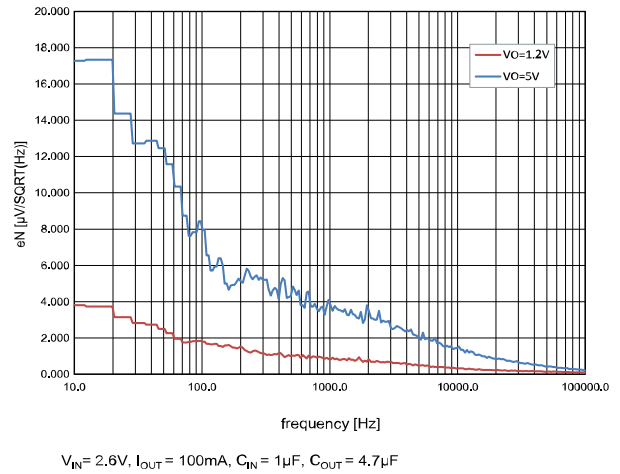


Figure 20. Stability plan ($V_{OUT} = 5\text{ V}$)

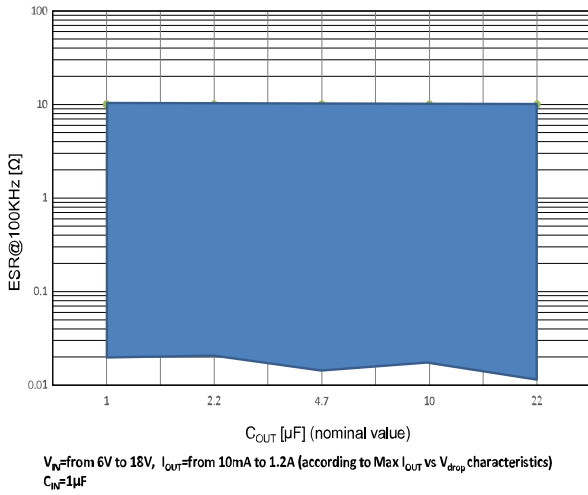


Figure 21. Stability plan ($V_{OUT} = 1.2\text{ V}$)

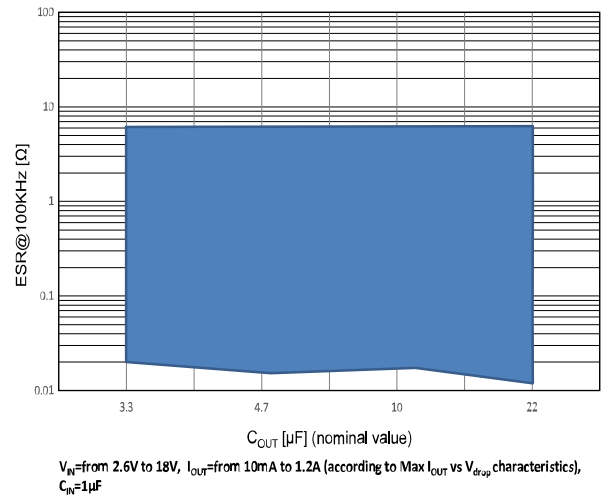


Figure 22. Turn-on time ($V_{OUT} = 5\text{ V}$)

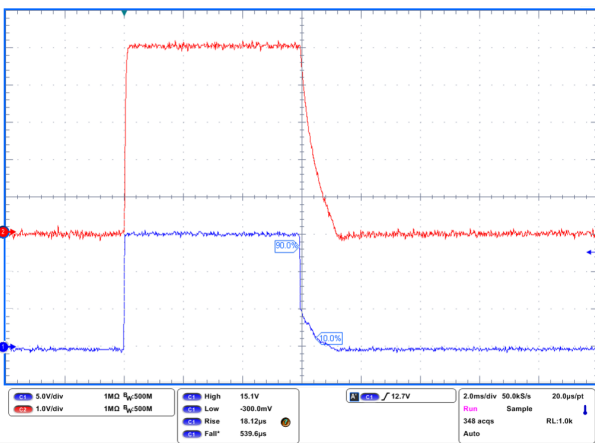


Figure 23. Turn-on time ($V_{OUT} = 1.2\text{ V}$)

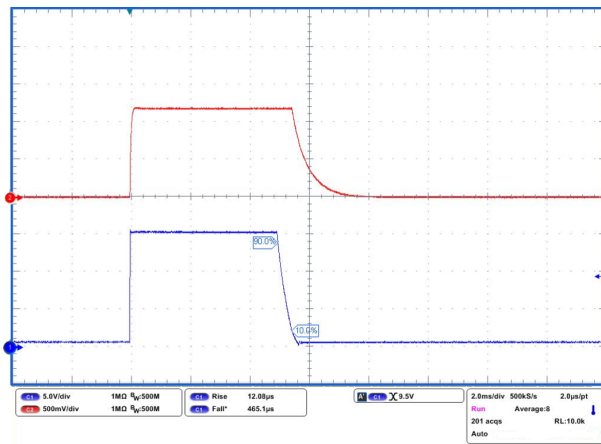


Figure 24. Line transient ($V_{OUT} = 5\text{ V}$)

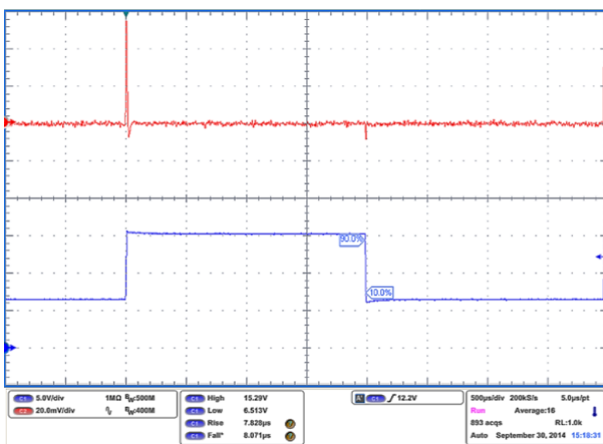


Figure 25. Line transient ($V_{OUT} = 1.2\text{ V}$)

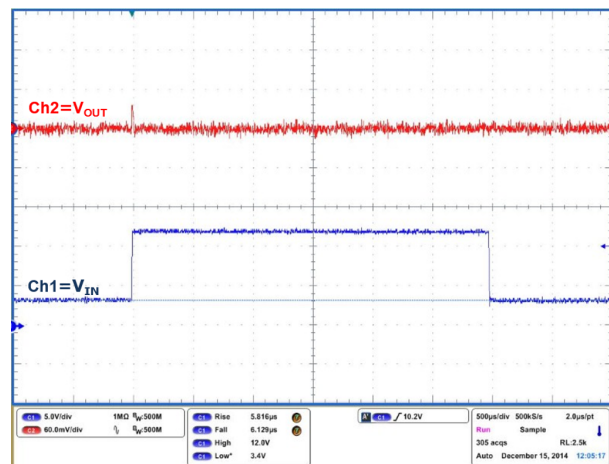
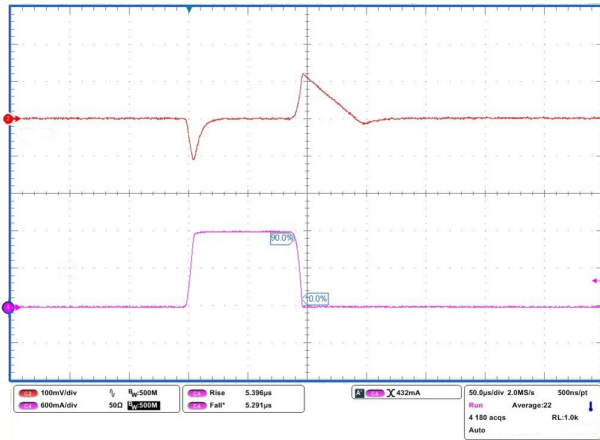
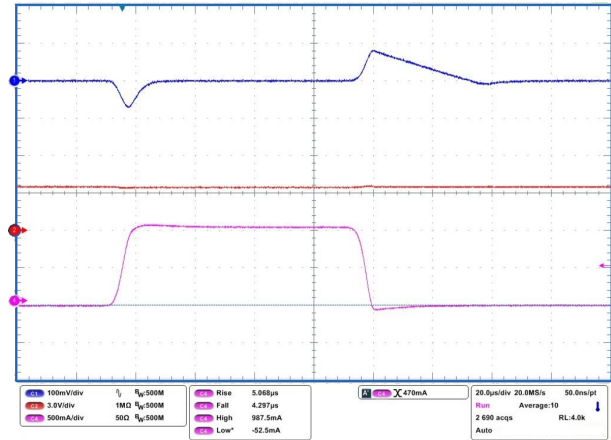


Figure 26. Load transient ($V_{OUT} = 5\text{ V}$)



$V_{IN} = 6\text{ V}$, $I_{OUT} = \text{from } 10\text{ mA to } 1.2\text{ A}$, NO C_{IN} , $C_{OUT} = 4.7\text{ }\mu\text{F}$, $t_{rise} = 5\text{ }\mu\text{s}$

Figure 27. Load transient ($V_{OUT} = 1.2\text{ V}$)



$V_{IN} = 3.5\text{ V}$, $I_{OUT} = \text{from } 10\text{ mA to } 1.2\text{ A}$, $C_{IN} = 1\text{ }\mu\text{F}$, $C_{OUT} = 4.7\text{ }\mu\text{F}$, $t_{rise} = 5\text{ }\mu\text{s}$

8 Package information

In order to meet environmental requirements, ST offers these devices in different grades of **ECOPACK** packages, depending on their level of environmental compliance. ECOPACK specifications, grade definitions and product status are available at: www.st.com. ECOPACK is an ST trademark.

8.1 SOT223 package information

Figure 28. SOT223 package outline

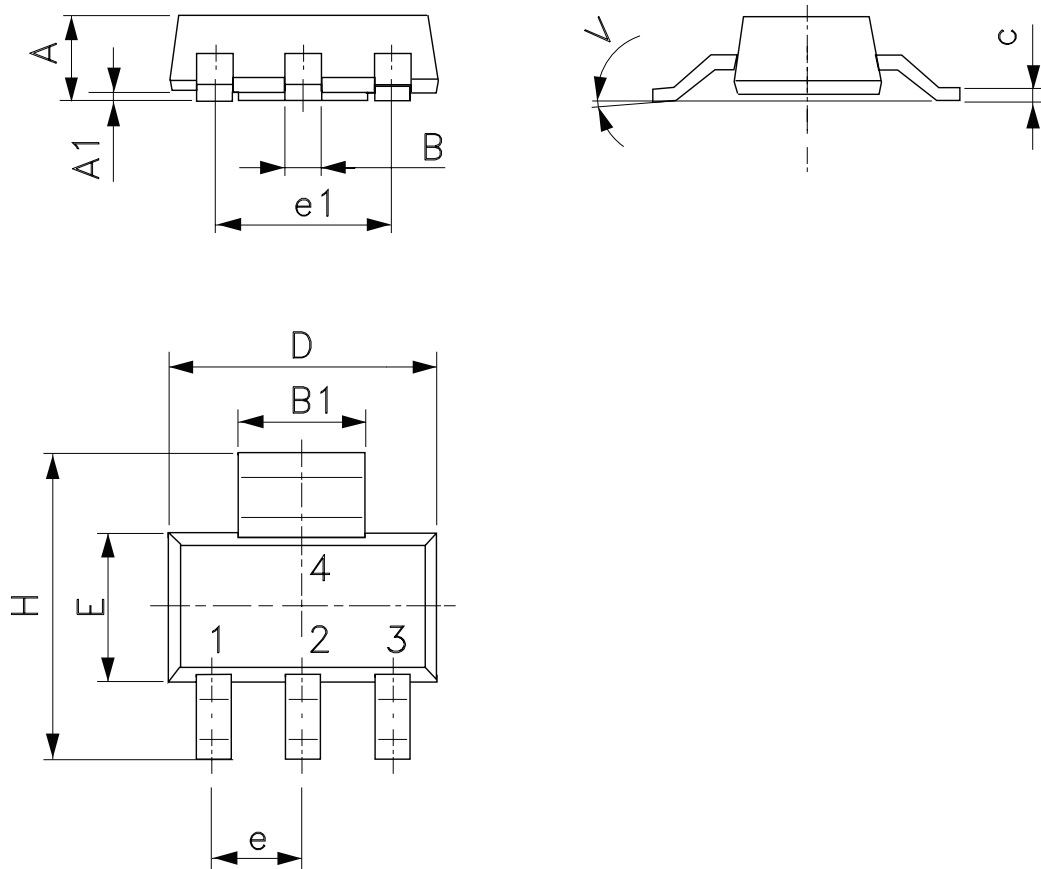


Table 5. SOT223 mechanical data

Dim.	mm		
	Min.	Typ.	Max.
A			1.8
A1	0.02		0.1
B	0.6	0.7	0.85
B1	2.9	3	3.15
c	0.24	0.26	0.35
D	6.3	6.5	6.7
e		2.3	
e1		4.6	
E	3.3	3.5	3.7
H	6.7	7.0	7.3
V			10°

8.2 SOT223 packing information

Table 6. SOT223 tape and reel mechanical data

Tape				Reel		
Dim.	mm			Dim.	mm	
	Min.	Typ.	Max.		Min.	Max.
A0	6.75	6.85	6.95	A		180
B0	7.30	7.40	7.50	N	60	
K0	1.80	1.90	2.00	W1		12.4
F	5.40	5.50	5.60	W2		18.4
E	1.65	1.75	1.85	W3	11.9	15.4
W	11.7	12	12.3			
P2	1.90	2	2.10	Base quantity pcs		1000
P0	3.90	4	4.10	Bulk quantity pcs		1000
P1	7.90	8	8.10			
T	0.25	0.30	0.35			
D	1.50	1.55	1.60			
D1	1.50	1.60	1.70			

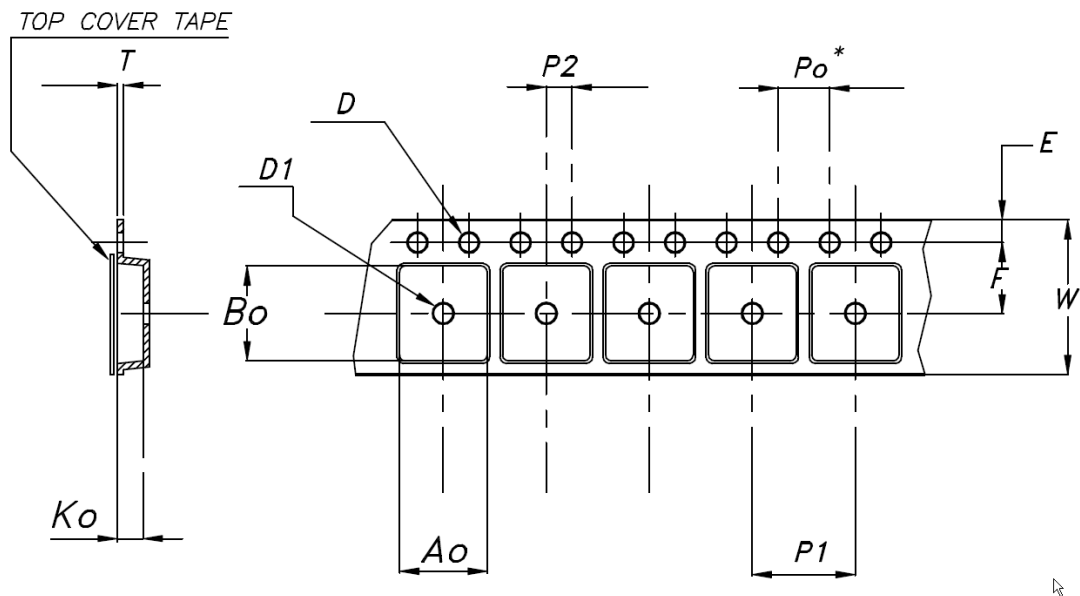
Figure 29. Tape for SOT223 (dimensions are in mm)


Figure 30. Reel for SOT223 (dimensions are in mm)

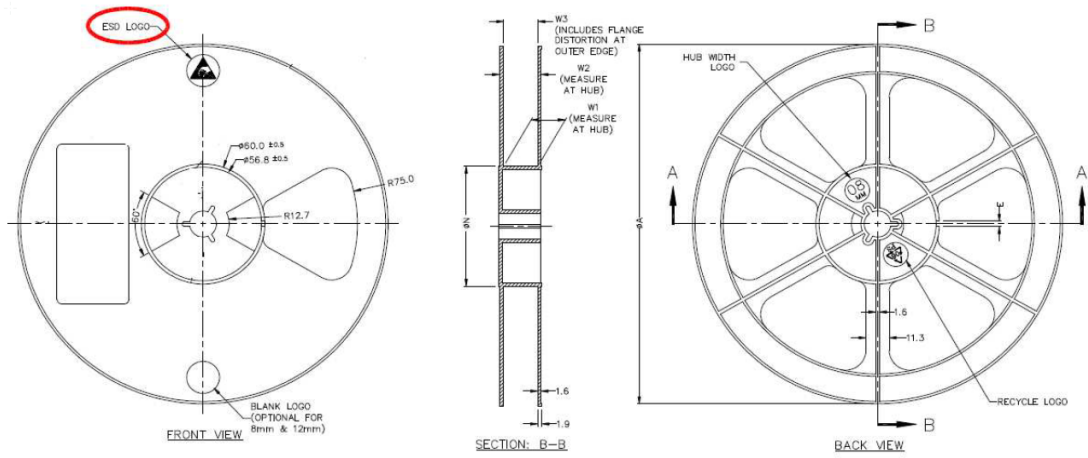
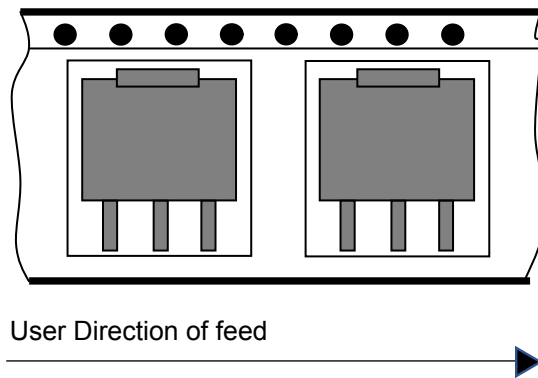


Figure 31. SOT223 reel oriented



9 Ordering information

Table 7. Order code

Part number	Marking	Order code	Output voltage (V)
LDL1117	LL12	LDL1117S12R	1.185
	LL15	LDL1117S15R	1.5
	LL18	LDL1117S18R	1.8
	LL25	LDL1117S25R	2.5
	LL30	LDL1117S30R	3.0
	LL33	LDL1117S33R	3.3
	LL50	LDL1117S50R	5.0

Revision history

Table 8. Document revision history

Date	Revision	Changes
27-Feb-2017	1	Initial release.
30-Mar-2017	2	Updated features in cover page and Section 9: "Ordering information". Minor text changes.
04-Jul-2017	3	In Table3: "Thermal data": - thermal data values changed. Minor textchanges.
04-Mar-2020	4	Updated Figure 28. SOT223 package outline.
24-Mar-2020	5	Updated Figure 12.
03-Apr-2020	6	Added Section 8.2 SOT223 packing information.
22-Jan-2021	7	Updated Figure 9 , Figure 22 , Figure 23 , Figure 24 , Figure 25 , Figure 26 and Figure 27 .

Contents

1	Diagram	2
2	Pin configuration	3
3	Typical application	4
4	Maximum ratings	5
5	Electrical characteristics	6
6	Application information	7
6.1	Thermal and short-circuit protections	7
6.2	Input and output capacitor selection	7
7	Typical characteristics	8
8	Package information	14
8.1	SOT223 package information	14
8.2	SOT223 packing information	16
9	Ordering information	18
	Revision history	19

List of tables

Table 1.	Pin description	3
Table 2.	Absolute maximum ratings	5
Table 3.	Thermal data	5
Table 4.	Electrical characteristics	6
Table 5.	SOT223 mechanical data	15
Table 6.	SOT223 tape and reel mechanical data	16
Table 7.	Order code	18
Table 8.	Document revision history	19

List of figures

Figure 1.	Block diagram	2
Figure 2.	Pin connection (top view)	3
Figure 3.	Typical application diagram	4
Figure 4.	Output voltage vs. temperature ($V_{IN} = 2.6\text{ V}$, $V_{OUT} = 1.2\text{ V}$, no load)	8
Figure 5.	Output voltage vs. temperature ($V_{IN} = 2.6\text{ V}$, $V_{OUT} = 1.2\text{ V}$, 1200 mA)	8
Figure 6.	Output voltage vs. temperature ($V_{IN} = 6\text{ V}$, $V_{OUT} = 5\text{ V}$, no load)	8
Figure 7.	Output voltage vs. temperature ($V_{IN} = 6\text{ V}$, $V_{OUT} = 5\text{ V}$, 1200 mA)	8
Figure 8.	Line regulation vs. temperature ($V_{IN} = 6\text{ to }18\text{ V}$, $V_{OUT} = 5\text{ V}$, $I_{OUT} = 10\text{ mA}$)	9
Figure 9.	Line regulation vs. temperature ($V_{IN} = 2.5\text{ to }18\text{ V}$, $V_{OUT} = 1.2\text{ V}$, $I_{OUT} = 10\text{ mA}$)	9
Figure 10.	Load regulation vs. temperature ($V_{IN} = 6\text{ V}$, $V_{OUT} = 5\text{ V}$, $I_{OUT} = 10\text{ to }1200\text{ mA}$)	9
Figure 11.	Load regulation vs. temperature ($V_{IN} = 2.6\text{ V}$, $V_{OUT} = 1.2\text{ V}$, $I_{OUT} = 10\text{ to }1200\text{ mA}$)	9
Figure 12.	Dropout voltage vs. temperature	10
Figure 13.	Quiescent current vs. temperature (no load)	10
Figure 14.	Quiescent current vs. temperature (600 mA)	10
Figure 15.	Quiescent current vs. temperature (1.2 A)	10
Figure 16.	Short-circuit current vs. dropout voltage ($V_{OUT} = 5\text{ V}$)	11
Figure 17.	Short-circuit current vs. dropout voltage ($V_{OUT} = 1.2\text{ V}$)	11
Figure 18.	SVR vs. frequency	11
Figure 19.	Output noise spectral density ($V_O = 1.2\text{ V}$)	11
Figure 20.	Stability plan ($V_{OUT} = 5\text{ V}$)	12
Figure 21.	Stability plan ($V_{OUT} = 1.2\text{ V}$)	12
Figure 22.	Turn-on time ($V_{OUT} = 5\text{ V}$)	12
Figure 23.	Turn-on time ($V_{OUT} = 1.2\text{ V}$)	12
Figure 24.	Line transient ($V_{OUT} = 5\text{ V}$)	12
Figure 25.	Line transient ($V_{OUT} = 1.2\text{ V}$)	12
Figure 26.	Load transient ($V_{OUT} = 5\text{ V}$)	13
Figure 27.	Load transient ($V_{OUT} = 1.2\text{ V}$)	13
Figure 28.	SOT223 package outline	14
Figure 29.	Tape for SOT223 (dimensions are in mm)	16
Figure 30.	Reel for SOT223 (dimensions are in mm)	17
Figure 31.	SOT223 reel oriented	17

IMPORTANT NOTICE – PLEASE READ CAREFULLY

STMicroelectronics NV and its subsidiaries (“ST”) reserve the right to make changes, corrections, enhancements, modifications, and improvements to ST products and/or to this document at any time without notice. Purchasers should obtain the latest relevant information on ST products before placing orders. ST products are sold pursuant to ST’s terms and conditions of sale in place at the time of order acknowledgement.

Purchasers are solely responsible for the choice, selection, and use of ST products and ST assumes no liability for application assistance or the design of Purchasers’ products.

No license, express or implied, to any intellectual property right is granted by ST herein.

Resale of ST products with provisions different from the information set forth herein shall void any warranty granted by ST for such product.

ST and the ST logo are trademarks of ST. For additional information about ST trademarks, please refer to www.st.com/trademarks. All other product or service names are the property of their respective owners.

Information in this document supersedes and replaces information previously supplied in any prior versions of this document.

© 2021 STMicroelectronics – All rights reserved

单击下面可查看定价，库存，交付和生命周期等信息

[>>STMicro\(意法半导体\)](#)