

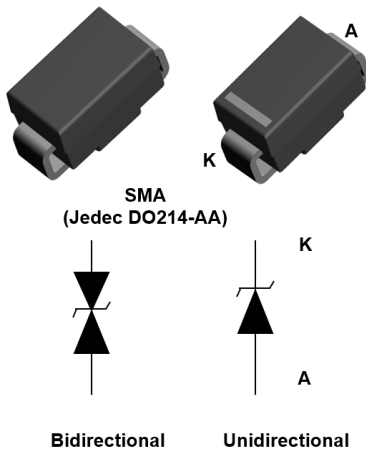

Automotive 400 W TVS in SMA



Features

- AEC-Q101 qualified 
- Peak pulse power:
 - 400 W (10/1000 μ s)
 - 2.3 kW (8/20 μ s)
- Stand-off voltage range from 5 V to 70 V
- Unidirectional and bidirectional types
- Low leakage current:
 - 0.2 μ A at 25 °C
 - 1 μ A at 85 °C
- Operating T_j max: 150 °C
- JEDEC registered package outline
- Resin meets UL94, V0

Product status link

[SM4T6V7AY](#), [SM4T6V7CAY](#),
[SM4T7V6AY](#), [SM4T7V6CAY](#),
[SM4T10AY](#), [SM4T10CAY](#),
[SM4T12AY](#), [SM4T12CAY](#),
[SM4T14AY](#), [SM4T14CAY](#),
[SM4T15AY](#), [SM4T15CAY](#),
[SM4T18AY](#), [SM4T18CAY](#),
[SM4T21AY](#), [SM4T21CAY](#),
[SM4T23AY](#), [SM4T23CAY](#),
[SM4T26AY](#), [SM4T26CAY](#),
[SM4T28AY](#), [SM4T28CAY](#),
[SM4T30AY](#), [SM4T30CAY](#),
[SM4T33AY](#), [SM4T33CAY](#),
[SM4T35AY](#), [SM4T35CAY](#),
[SM4T39AY](#), [SM4T39CAY](#),
[SM4T47AY](#), [SM4T47CAY](#),
[SM4T50AY](#), [SM4T50CAY](#),
[SM4T56AY](#), [SM4T56CAY](#),
[SM4T68AY](#), [SM4T68CAY](#),
[SM4T82AY](#), [SM4T82CAY](#)

Complies with the following standards

- ISO 10605, C = 150 pF, R = 330 Ω :
 - 30 kV (air discharge)
 - 30 kV (contact discharge)
- ISO 10605, C = 330 pF, R = 330 Ω :
 - 30 kV (air discharge)
 - 30 kV (contact discharge)
- ISO 7637-2 (not applicable to parts with V_{RM} lower than battery voltage 13.5 V):
 - Pulse 1: $V_S = -150$ V
 - Pulse 2a: $V_S = +112$ V
 - Pulse 3a: $V_S = -200$ V
 - Pulse 3b: $V_S = +150$ V

Description

The SM4TY series are designed to protect sensitive automotive circuits against surges defined in ISO 7637-2 and against electrostatic discharges according to ISO 10605.

The Planar technology makes it compatible with high-end circuits where low leakage current and high junction temperature are required to provide long term reliability and stability. SM4TY devices are packaged in SMA (SMA footprint in accordance with IPC 7531 standard).

1 Characteristics

Table 1. Absolute maximum ratings ($T_{amb} = 25\text{ }^{\circ}\text{C}$)

Symbol	Parameter	Value	Unit	
V_{PP}	Peak pulse voltage	IEC 61000-4-2 (C = 150 pF, R = 330 Ω)	kV	
		Contact discharge		30
		Air discharge		30
		ISO10605 (C = 330 pF, R = 330 Ω)		
P_{PP}	Peak pulse power dissipation	T_j initial = T_{amb}	400	W
T_{stg}	Storage temperature range	-65 to +150	$^{\circ}\text{C}$	
T_j	Operating junction temperature range	-55 to +150	$^{\circ}\text{C}$	
T_L	Maximum lead temperature for soldering during 10 s	260	$^{\circ}\text{C}$	

Figure 1. Electrical characteristics - parameter definitions

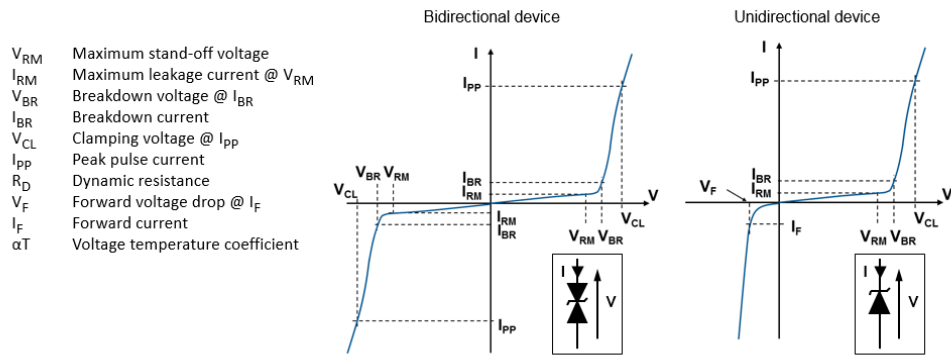

Figure 2. Pulse definition for electrical characteristics

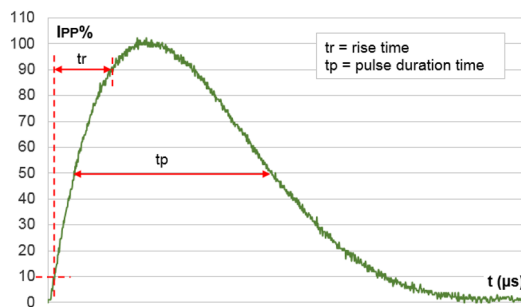

Table 2. Electrical characteristics - parameter values ($T_{amb} = 25\text{ °C}$, unless otherwise specified)

Type	I_{RM} max at V_{RM}			V_{BR} at I_R ⁽¹⁾				10 / 1000 μ s			8 / 20 μ s			αT
								V_{CL} ⁽²⁾⁽³⁾	I_{PP} ⁽⁴⁾	R_D	V_{CL} ⁽²⁾⁽³⁾	I_{PP} ⁽⁴⁾	R_D	
	25 °C	85 °C		Min.	Typ.	Max.		Max.		Max.	Max.		Max.	
	μ A	μ A	V	V	V	V	mA	V	A	Ω	V	A	Ω	$10^{-4}/\text{°C}$
SM4T6V7AY/CAY	20	50	5	6.4	6.74	7.1	10	9.2	43.5	0.049	13.4	174	0.036	5.7
SM4T7V6AY/CAY	20	50	6.5	7.2	7.58	8	10	11.2	35.7	0.091	14.5	160	0.041	6.1
SM4T10AY/CAY	20	50	8.5	9.4	9.9	10.4	1	14.4	27.7	0.145	19.5	124	0.073	7.3
SM4T12AY/CAY	0.2	1	10	11.1	11.7	12.3	1	17	23.5	0.201	21.7	106	0.089	7.8
SM4T14AY/CAY	0.2	1	12	13.3	14	14.7	1	19.9	20.1	0.259	25.3	91	0.116	8.3
SM4T15AY/CAY	0.2	1	13	14.4	15.2	16	1	21.5	18.6	0.298	27.2	85	0.132	8.4
SM4T18AY/CAY	0.2	1	15	16.7	17.6	18.5	1	24.4	16.4	0.361	32.5	71	0.197	8.8
SM4T21AY/CAY	0.2	1	18	20.0	21.1	22.2	1	29.2	13.7	0.514	39.3	59	0.291	9.2
SM4T23AY/CAY	0.2	1	20	22.2	23.4	24.6	1	32.4	12.3	0.637	42.8	54	0.338	9.4
SM4T26AY/CAY	0.2	1	22	24.4	25.7	27	1	35.5	11.2	0.760	48.3	48	0.444	9.6
SM4T28AY/CAY	0.2	1	24	26.7	28.1	29.5	1	38.9	10.3	0.912	50	46	0.446	9.6
SM4T30AY/CAY	0.2	1	26	28.9	30.4	31.9	1	42.1	9.5	1.07	53.5	43	0.502	9.7
SM4T33AY/CAY	0.2	1	28	31.1	32.7	34.3	1	45.4	8.8	1.26	59	39	0.632	9.8
SM4T35AY/CAY	0.2	1	30	33.3	35.1	36.9	1	48.4	8.3	1.39	64.3	36	0.762	9.9
SM4T39AY/CAY	0.2	1	33	36.7	38.6	40.5	1	53.3	7.5	1.70	69.7	33	0.884	10
SM4T47AY/CAY	0.2	1	40	44.4	46.7	49	1	64.5	6.2	2.49	84	27	1.30	10.1
SM4T50AY/CAY	0.2	1	43	47.8	50.3	52.8	1	69.4	5.7	2.91	91	25	1.53	10.2
SM4T56AY/CAY	0.2	1	48	53.3	56.1	58.9	1	77.4	5.2	3.56	100	23	1.79	10.3
SM4T68AY/CAY	0.2	1	58	64.4	67.8	71.2	1	93.6	4.3	5.21	121	19	2.62	10.4
SM4T82AY/CAY	0.2	1	70	77.8	81.9	86	1	113	3.5	7.72	146	16	3.75	10.5

1. To calculate V_{BR} versus T_j : V_{BR} at $T_j = V_{BR}$ at $25\text{ °C} \times (1 + \alpha T \times (T_j - 25))$
2. To calculate V_{CL} versus T_j : V_{CL} at $T_j = V_{CL}$ at $25\text{ °C} \times (1 + \alpha T \times (T_j - 25))$
3. To calculate V_{CL} max versus $I_{PP\text{appli}}$: $V_{CL\text{max}} = V_{CL} - R_D \times (I_{PP} - I_{PP\text{appli}})$ where $I_{PP\text{appli}}$ is the surge current in the application
4. Surge capability given for both directions for unidirectional and bidirectional devices

1.1 Characteristics (curves)

Figure 3. Maximum peak power dissipation versus initial junction temperature

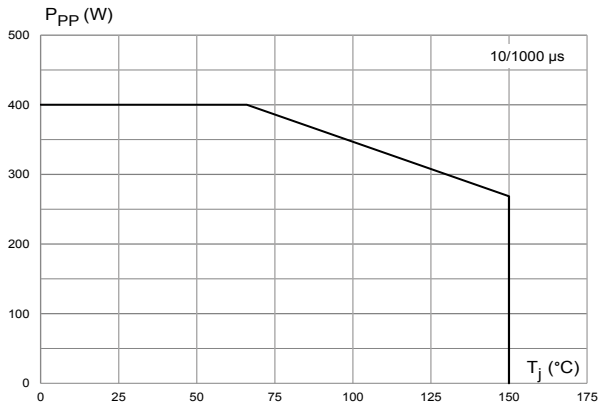

Figure 4. Maximum peak pulse power versus exponential pulse duration

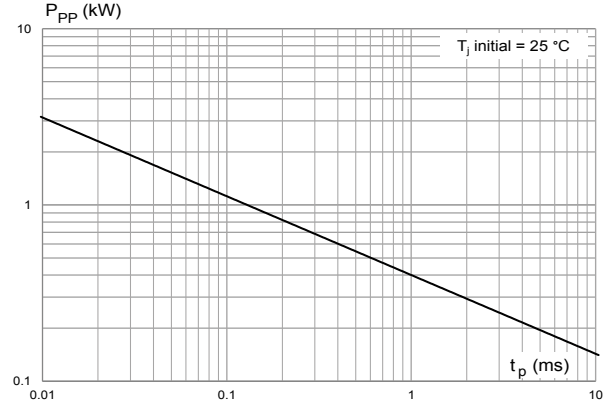

Figure 5. Maximum peak pulse current versus clamping voltage

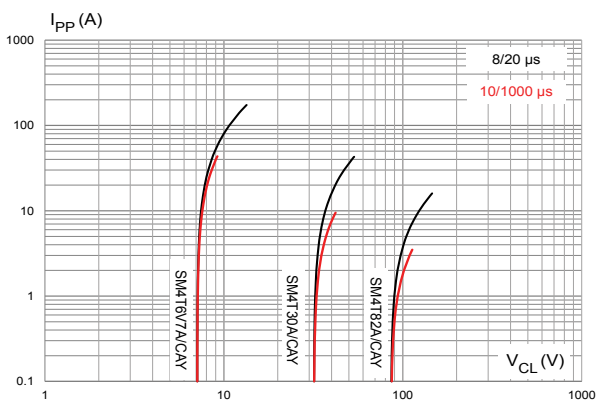

Figure 6. Dynamic resistance versus pulse duration

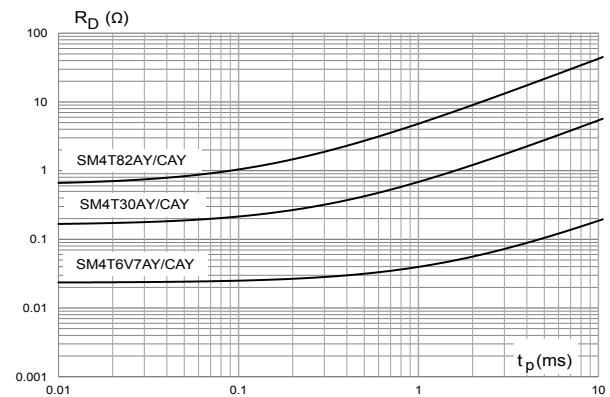

Figure 7. Junction capacitance versus reverse applied voltage (unidirectional type)

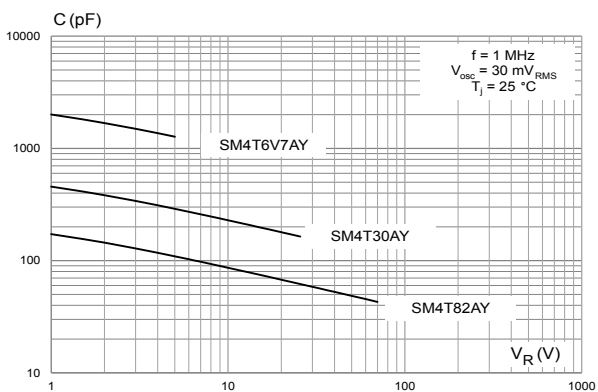

Figure 8. Junction capacitance versus applied voltage (bidirectional type)

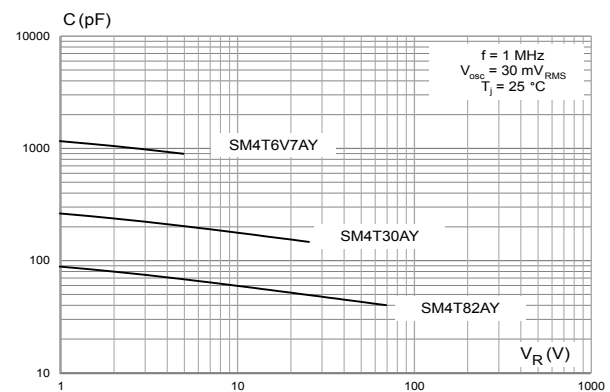

Figure 9. Leakage current versus junction temperature

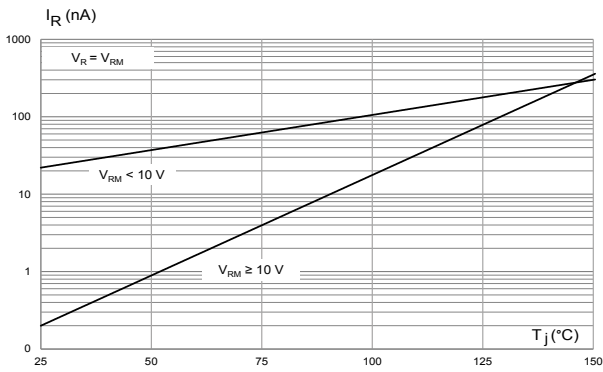

Figure 10. Peak forward voltage drop versus peak forward current

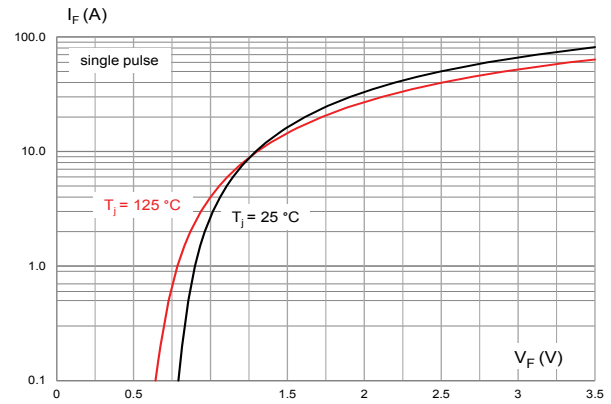

Figure 11. Thermal impedance junction to ambient versus pulse duration

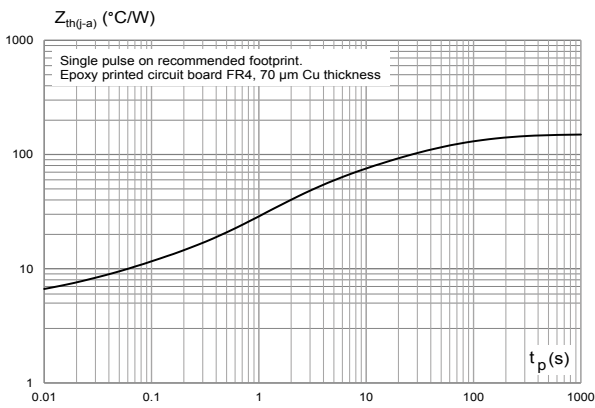

Figure 12. Thermal resistance junction to ambient versus copper area under each lead

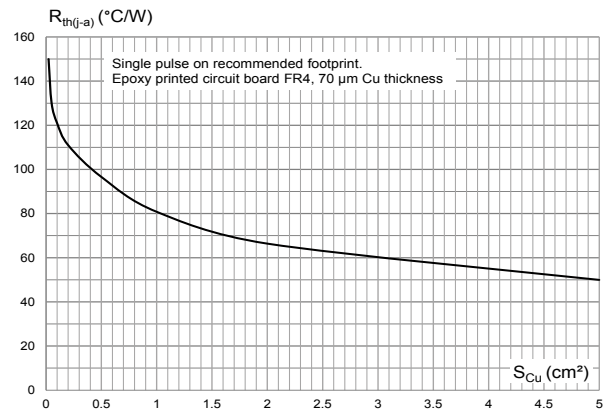

Figure 13. ISO7637-2 pulse 1: $V_s = -150\text{ V}$ with 12 V battery

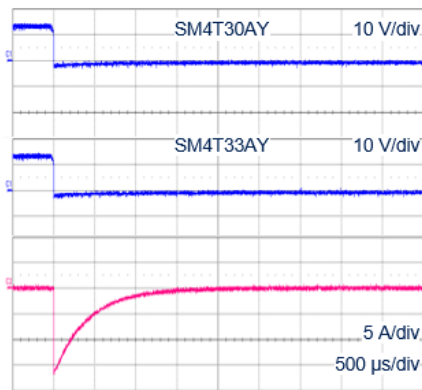

Figure 14. ISO7637-2 pulse 2a: $V_s = +112\text{ V}$ with 12 V battery

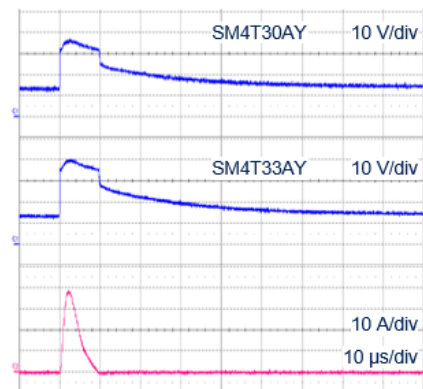

Figure 15. ISO7637-2 pulse 3a: $V_s = -220\text{ V}$ with 12 V battery

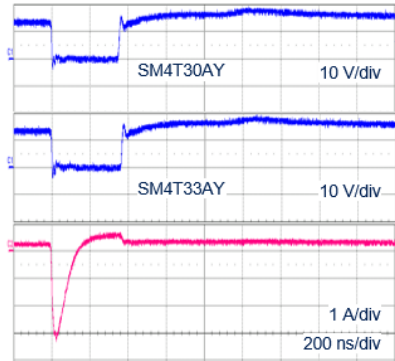
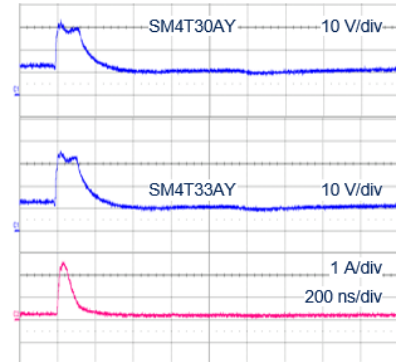

Figure 16. ISO7637-2 pulse 3b: $V_s = +150\text{ V}$ with 12 V battery



2 Package information

In order to meet environmental requirements, ST offers these devices in different grades of **ECOPACK** packages, depending on their level of environmental compliance. ECOPACK specifications, grade definitions and product status are available at: www.st.com. ECOPACK is an ST trademark.

2.1 SMA package information

Figure 17. SMA package outline

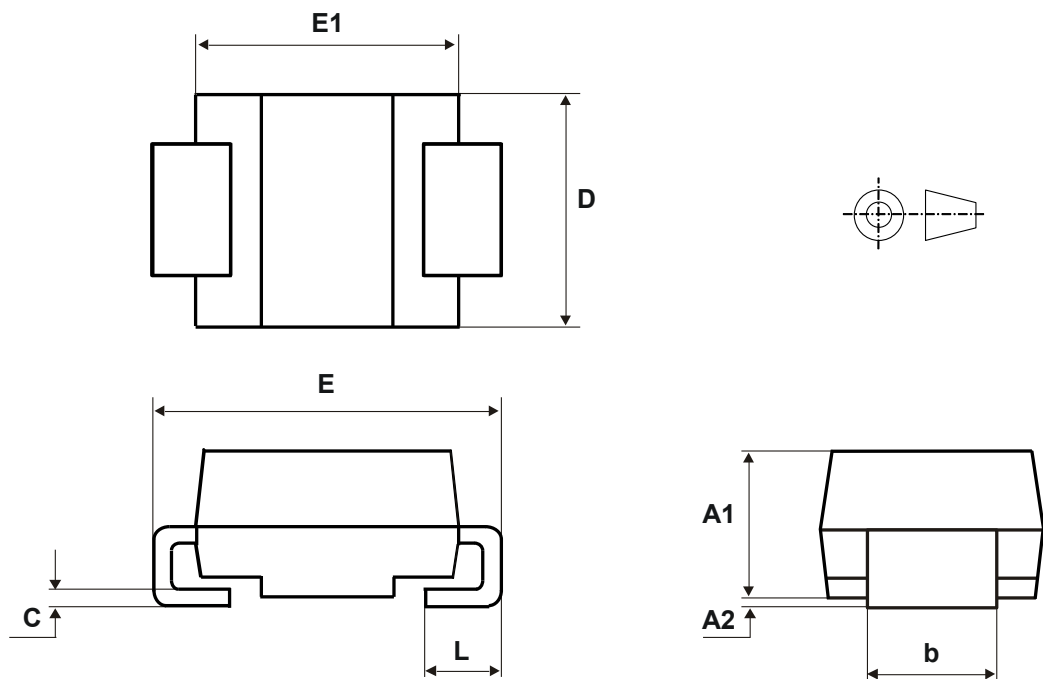

Table 3. SMA package mechanical data

Ref.	Dimensions			
	Millimeters		Inches	
	Min.	Max.	Min.	Max.
A1	1.90	2.45	0.074	0.097
A2	0.05	0.20	0.001	0.008
b	1.25	1.65	0.049	0.065
c	0.15	0.40	0.005	0.016
D	2.25	2.90	0.088	0.115
E	4.80	5.35	0.188	0.211
E1	3.95	4.60	0.155	0.182
L	0.75	1.50	0.029	0.060

Figure 18. SMA recommended footprint in mm (inches)

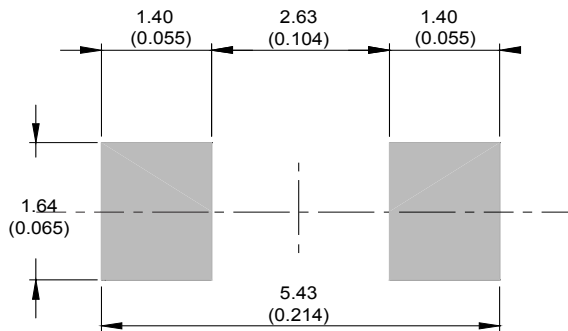

Figure 19. SMA marking

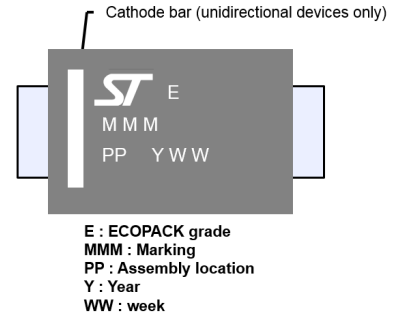
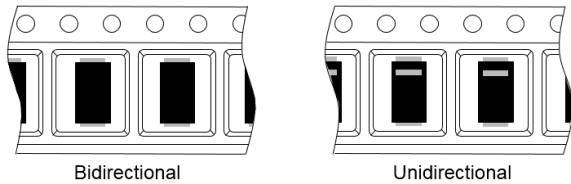

Figure 20. Package orientation in reel



Taped according to EIA-481
Pocket dimensions are not on scale.
Pocket shape may vary depending on package
On bidirectional devices, marking and logo may not be always in the same direction.

Figure 21. Tape and reel orientation

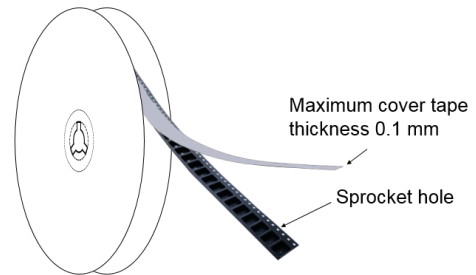

Figure 22. 13" reel dimension values

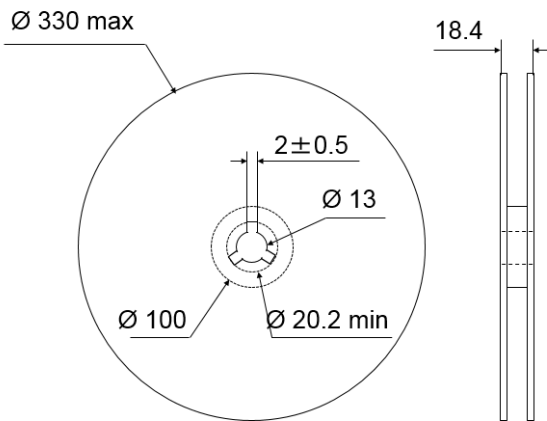

Figure 23. Inner box dimension values

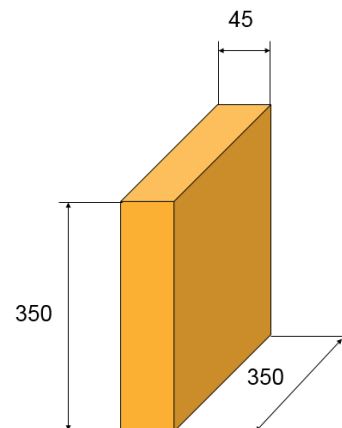
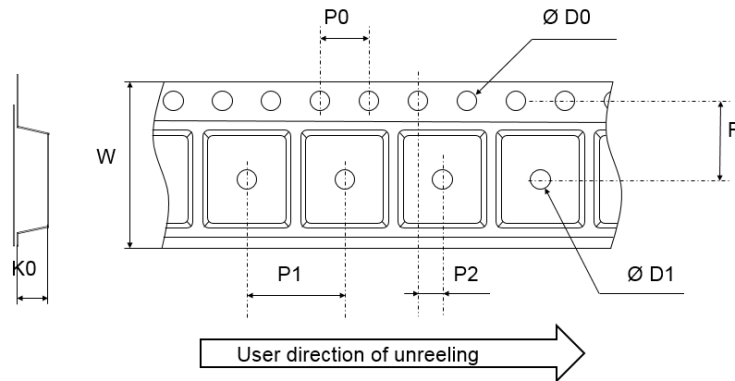

Figure 24. Tape outline



Note: Pocket dimensions are not on scale
Pocket shape may vary depending on package

Table 4. Tape dimension values

Ref.	Dimensions		
	Millimeters		
	Min.	Typ.	Max.
D0	1.40	1.50	1.60
D1	1.50		
F	5.40	5.50	5.60
K0	2.26	2.36	2.46
P0	3.90	4.00	4.10
P1	3.90	4.00	4.10
P2	1.95	2.00	2.05
W	11.70	12.00	12.30

2.2 Reflow profile

Figure 25. ST ECOPACK recommended soldering reflow profile for PCB mounting

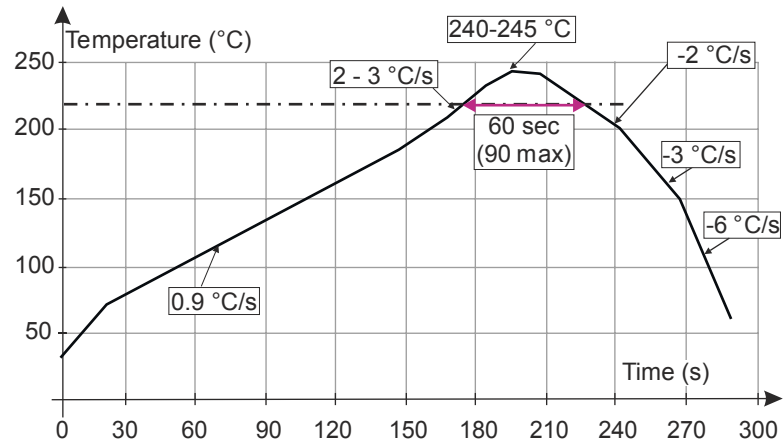

Note: Minimize air convection currents in the reflow oven to avoid component movement. Maximum soldering profile corresponds to the latest IPC/JEDEC J-STD-020.

3 Application and design guidelines

More information is available in the application note AN2689 “Protection of automotive electronics from electrical hazards, guidelines for design and component selection”.

4 Ordering information

Table 5. Ordering information

Order code	Marking	Package	Weight	Base qty.	Delivery mode
SM4TxxAY/CAY ⁽¹⁾	See Table 6. Marking.	SMA	72 mg	5000	Tape and reel

1. Where xx is nominal value of V_{BR} and A or CA indicates unidirectional or bidirectional version.

Table 6. Marking

Order code	Marking	Order code	Marking
SM4T6V7AY	AEY	SM4T6V7CAY	AA \bar{Y}
SM4T7V6AY	DUCY	SM4T7V6CAY	DBC \bar{Y}
SM4T10AY	DUHY	SM4T10CAY	DBH \bar{Y}
SM4T12AY	AXY	SM4T12CAY	AC \bar{Y}
SM4T14AY	DUKY	SM4T14CAY	DBK \bar{Y}
SM4T15AY	BGY	SM4T15CAY	BH \bar{Y}
SM4T18AY	BM \bar{Y}	SM4T18CAY	AJ \bar{Y}
SM4T21AY	DUQY	SM4T21CAY	DBQ \bar{Y}
SM4T23AY	DURY	SM4T23CAY	DBR \bar{Y}
SM4T26AY	DUSY	SM4T26CAY	DBS \bar{Y}
SM4T28AY	DUTY	SM4T28CAY	DBT \bar{Y}
SM4T30AY	DUUY	SM4T30CAY	DBU \bar{Y}
SM4T33AY	CGY	SM4T33CAY	CH \bar{Y}
SM4T35AY	CKY	SM4T35CAY	CL \bar{Y}
SM4T39AY	CMY	SM4T39CAY	CN \bar{Y}
SM4T47AY	DUZY	SM4T47CAY	DBZ \bar{Y}
SM4T50AY	EUAY	SM4T50CAY	EB \bar{A} \bar{Y}
SM4T56AY	CXY	SM4T56CAY	C \bar{Y}
SM4T68AY	EUFY	SM4T68CAY	EBF \bar{Y}
SM4T82AY	EUIY	SM4T82CAY	EBI \bar{Y}

Note: Marking differentiation between unidirectional and bidirectional devices is done with cathode bar.

Revision history

Table 7. Document revision history

Date	Version	Changes
08-Sep-2010	1	Initial release.
09-Nov-2011	2	Added order codes in Table 2 and Table 4. Updated Figure 5, 6 and 7.
27-Mar-2012	3	Added footnote on page 1.
05-Oct-2015	4	Updated Table 1.
26-Jan-2022	5	Minor text changes.

IMPORTANT NOTICE – PLEASE READ CAREFULLY

STMicroelectronics NV and its subsidiaries (“ST”) reserve the right to make changes, corrections, enhancements, modifications, and improvements to ST products and/or to this document at any time without notice. Purchasers should obtain the latest relevant information on ST products before placing orders. ST products are sold pursuant to ST’s terms and conditions of sale in place at the time of order acknowledgement.

Purchasers are solely responsible for the choice, selection, and use of ST products and ST assumes no liability for application assistance or the design of Purchasers’ products.

No license, express or implied, to any intellectual property right is granted by ST herein.

Resale of ST products with provisions different from the information set forth herein shall void any warranty granted by ST for such product.

ST and the ST logo are trademarks of ST. For additional information about ST trademarks, please refer to www.st.com/trademarks. All other product or service names are the property of their respective owners.

Information in this document supersedes and replaces information previously supplied in any prior versions of this document.

© 2022 STMicroelectronics – All rights reserved

单击下面可查看定价，库存，交付和生命周期等信息

[>>STMicro\(意法半导体\)](#)