

## 60 V, 3 A low drop Schottky rectifier

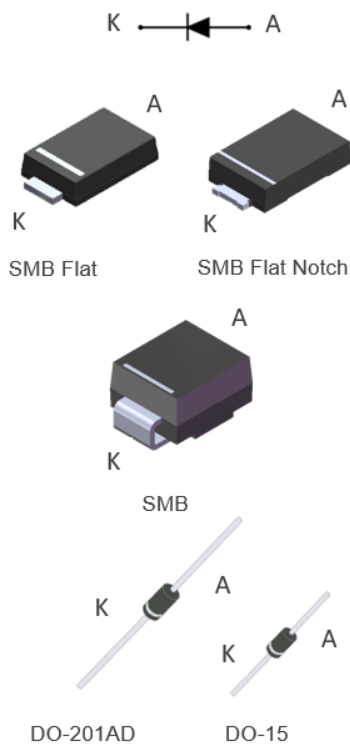

## Features

- Negligible switching losses
- Low forward voltage drop
- Avalanche rated
- ECOPACK2 component

## Applications

- Switching diode
- SMPS
- DC/DC converter
- LED lighting

## Description

Axial and surface mount power Schottky rectifier suited for switch mode power supplies and high frequency dc to dc converters.

Packaged in DO-201AD, DO-15, SMB, SMBflat and SMBflat Notch, this device is intended for use in low voltage, high frequency inverters and small battery chargers and for applications where there are space constraints, for example telecom battery charger.

Product status	
STPS3L60	
Product summary	
Symbol	Value
$I_{F(AV)}$	3 A
$V_{RRM}$	60 V
$T_{j(max.)}$	150 °C
$V_F(typ.)$	0.53 V

# 1 Characteristics

**Table 1. Absolute ratings (limiting values at 25 °C, unless otherwise specified)**

Symbol	Parameter		Value	Unit	
$V_{RRM}$	Repetitive peak reverse voltage		60	V	
$I_{F(RMS)}$	Forward rms current		10	A	
$I_{F(AV)}$	Average forward current, $\delta = 0.5$ , square wave	SMB Flat Notch, SMB Flat	$T_L = 115\text{ °C}$	3	A
		SMB, DO-201AD	$T_L = 105\text{ °C}$		
		DO-15	$T_L = 72\text{ °C}$		
$I_{FSM}$	Surge non repetitive forward current		$t_p = 10\text{ ms}$ sinusoidal	100	A
$P_{ARM}$	Repetitive peak avalanche power		$t_p = 10\text{ }\mu\text{s}$ , $T_j = 125\text{ °C}$	144	W
$T_{stg}$	Storage temperature range		-65 to +150	°C	
$T_j$	Maximum operating junction temperature <sup>(1)</sup>		+150	°C	

1.  $(dP_{tot}/dT_j) < (1/R_{th(j-a)})$  condition to avoid thermal runaway for a diode on its own heatsink.

**Table 2. Thermal resistance parameter**

Symbol	Parameter		Max. value	Unit
$R_{th(j-l)}$	Junction to leads	SMB Flat Notch, SMB Flat	15	°C/W
		SMB	20	
	Junction to leads, lead length = 10 mm	DO-201AD	20	
		DO-15	35	

For more information, please refer to the following application note :

- AN5088 : Rectifiers thermal management, handling and mounting recommendations

**Table 3. Static electrical characteristics**

Symbol	Parameter	Test conditions		Min.	Typ.	Max.	Unit
$I_R^{(1)}$	Reverse leakage current	$T_j = 25\text{ °C}$	$V_R = V_{RRM}$	-		150	$\mu\text{A}$
		$T_j = 100\text{ °C}$		4	15	mA	
		$T_j = 125\text{ °C}$		-	14		30
$V_F^{(1)}$	Forward voltage drop	$T_j = 25\text{ °C}$	$I_F = 3\text{ A}$	-		0.62	V
		$T_j = 100\text{ °C}$		0.53	0.61		
		$T_j = 125\text{ °C}$		-	0.51	0.59	
		$T_j = 25\text{ °C}$	$I_F = 6\text{ A}$	-		0.79	
		$T_j = 100\text{ °C}$		0.62	0.71		
		$T_j = 125\text{ °C}$		-	0.6	0.69	

1. Pulse test:  $t_p = 380\text{ }\mu\text{s}$ ,  $\delta < 2\%$

To evaluate the conduction losses, use the following equation:

$$P = 0.44 \times I_{F(AV)} + 0.05 \times I_{F(RMS)}^2$$

For more information, please refer to the following application notes related to the power losses :

- AN604: Calculation of conduction losses in a power rectifier
- AN4021: Calculation of reverse losses on a power diode

## 1.1 Characteristics (curves)

**Figure 1. Average forward power dissipation versus average forward current**

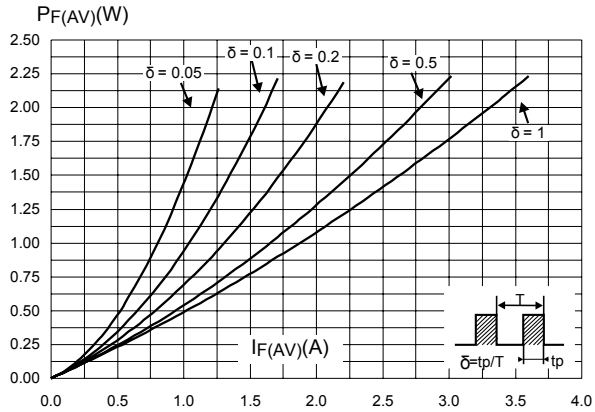

**Figure 2. Average forward current versus ambient temperature ( $\delta = 0.5$ ) (SMB Flat, SMB Flat Notch)**

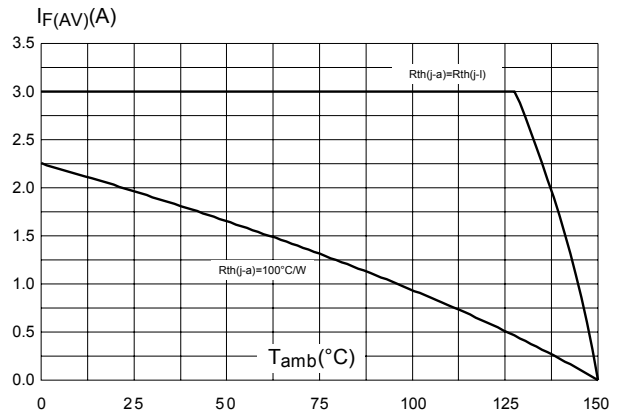

**Figure 3. Average forward current versus ambient temperature ( $\delta = 0.5$ ) (DO-201AD, SMB)**

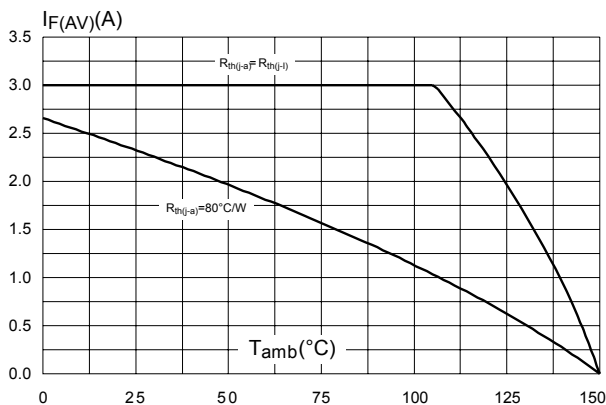

**Figure 4. Average forward current versus ambient temperature ( $\delta = 0.5$ ) (DO-15)**

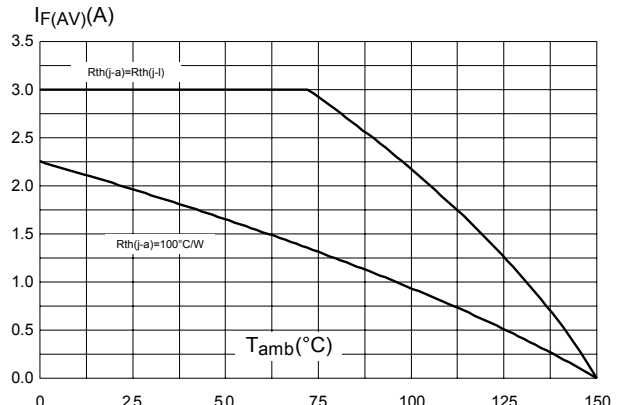

**Figure 5. Normalized avalanche power derating versus pulse duration ( $T_j = 125^{\circ}C$ )**

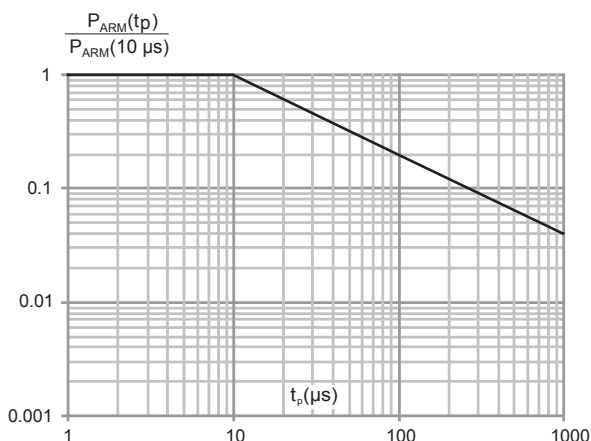

**Figure 6. Relative variation of thermal impedance junction to lead versus pulse duration (SMB Flat, SMB Flat Notch)**

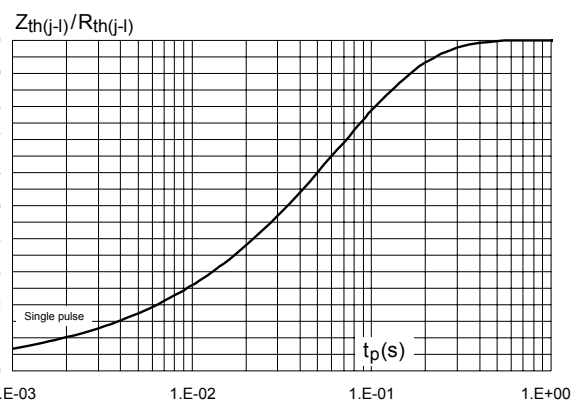

**Figure 7. Relative variation of thermal impedance junction to ambient versus pulse duration (SMB)**

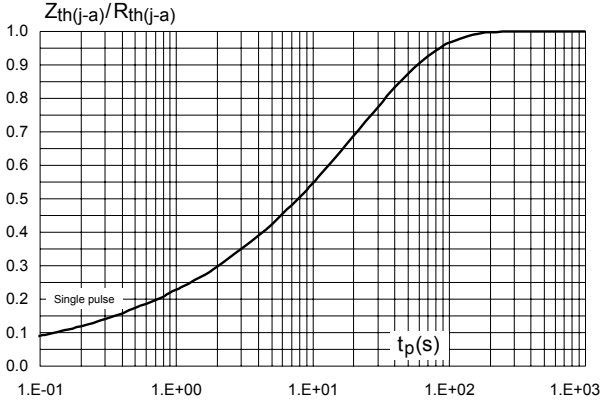

**Figure 8. Relative variation of thermal impedance junction to ambient versus pulse duration (DO-201AD)**

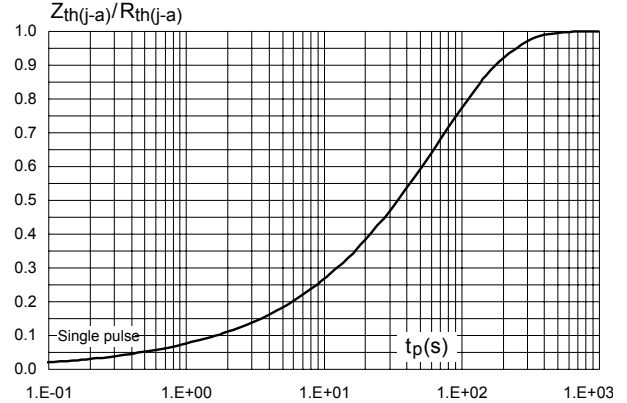

**Figure 9. Relative variation of thermal impedance junction to ambient versus pulse duration (DO-15)**

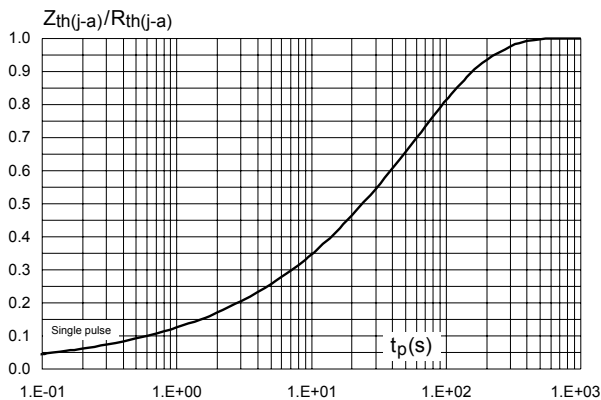

**Figure 10. Reverse leakage current versus reverse voltage applied (typical values)**

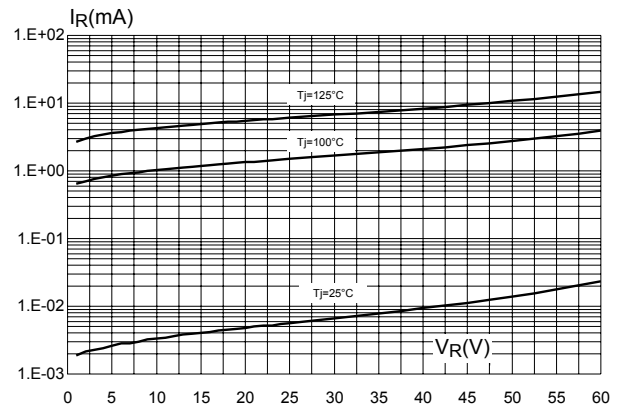

**Figure 11. Junction capacitance versus reverse voltage applied (typical values)**

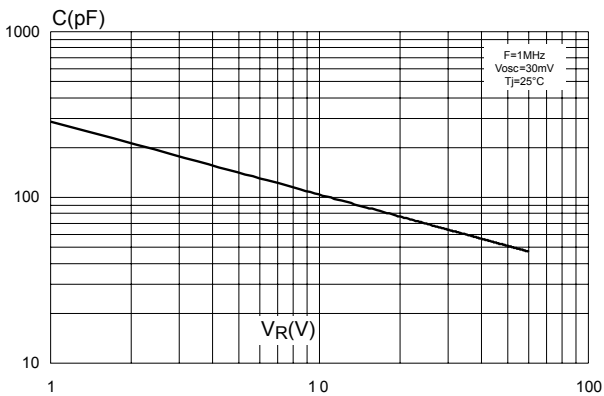

**Figure 12. Forward voltage drop versus forward current (high level)**

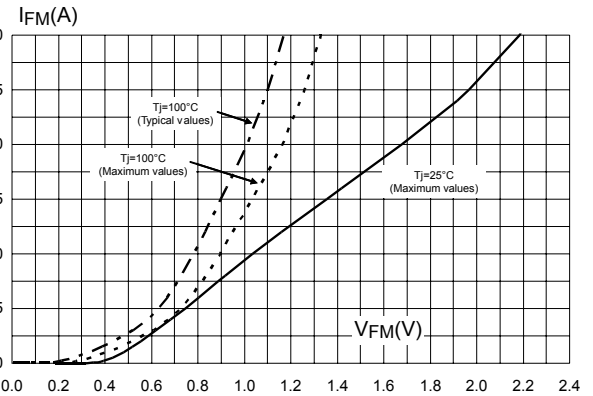

**Figure 13. Forward voltage drop versus forward current (low level)**

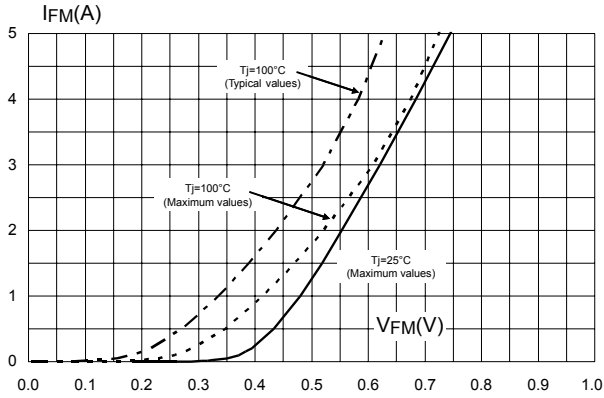

**Figure 14. Thermal resistance junction to ambient versus copper surface under each lead (SMB flat, SMB flat Notch)**

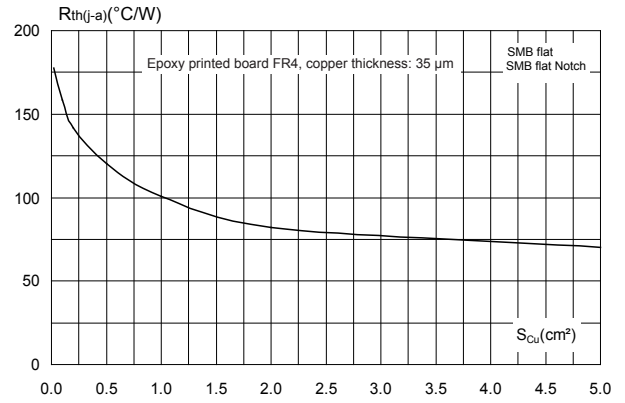

**Figure 15. Thermal resistance junction to ambient versus copper surface under each lead (SMB)**

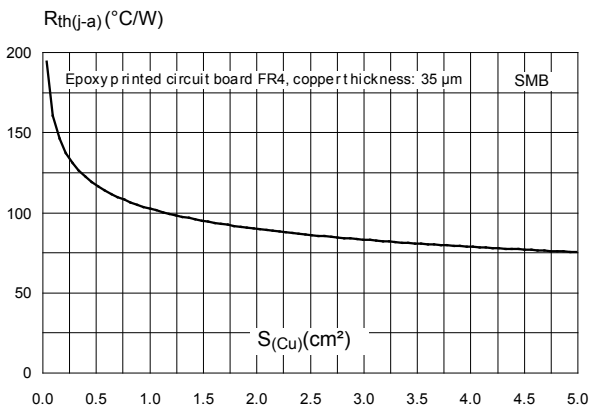

**Figure 16. Thermal resistance versus lead length (DO-15)**

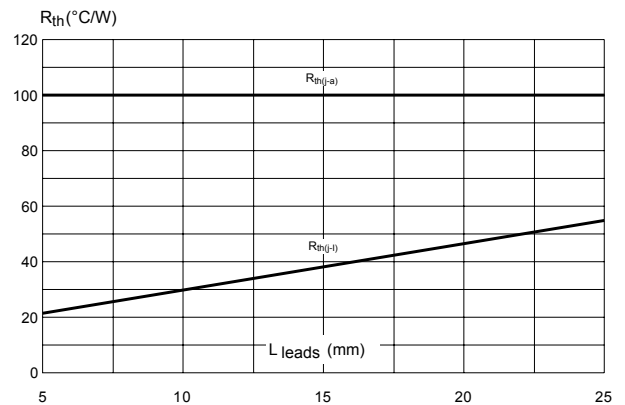

**Figure 17. Thermal resistance versus lead length**

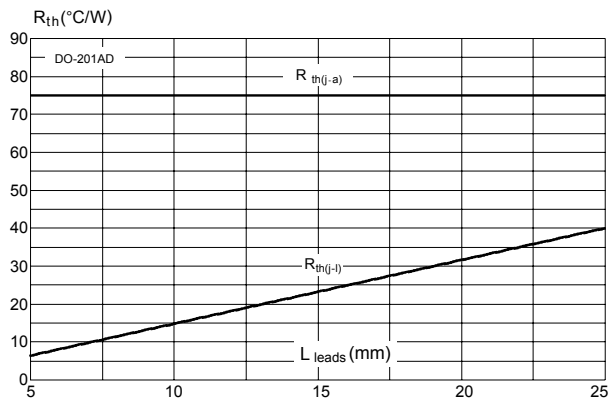

## 2 Package information

In order to meet environmental requirements, ST offers these devices in different grades of **ECOPACK** packages, depending on their level of environmental compliance. ECOPACK specifications, grade definitions and product status are available at: [www.st.com](http://www.st.com). ECOPACK is an ST trademark.

### 2.1 SMB Flat Notch package information

- Epoxy meets UL94, V0
- Lead-free package

Figure 18. SMB Flat Notch package outline

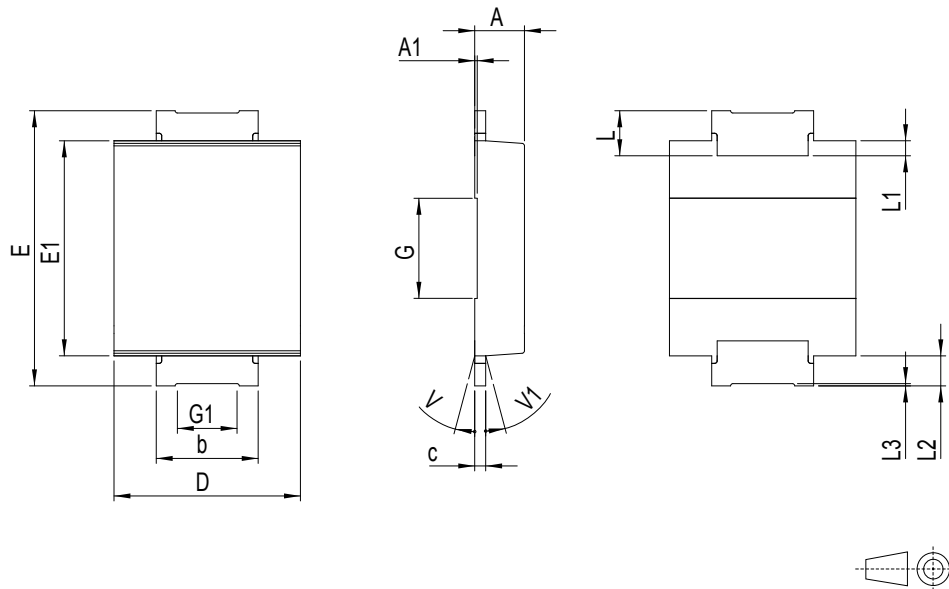

**Table 4. SMB Flat Notch mechanical data**

Ref.	Dimensions					
	Millimeters			Inches		
	Min.	Typ.	Max.	Min.	Typ.	Max.
A	0.90		1.10	0.035		0.043
A1		0.05			0.002	
b	1.95		2.20	0.077		0.087
c	0.15		0.40	0.006		0.016
D	3.30		3.95	0.130		0.156
E	5.20		5.60	0.205		0.220
E1	4.05		4.60	0.159		0.181
G		2.00			0.079	
G1		1.20			0.047	
L	0.75		1.20	0.030		0.047
L1		0.30			0.012	
L2		0.60			0.024	
L3	0.02			0.001		
V			8°			8°
V1			8°			8°

**Figure 19. Footprint recommendations, dimensions in mm (inches)**

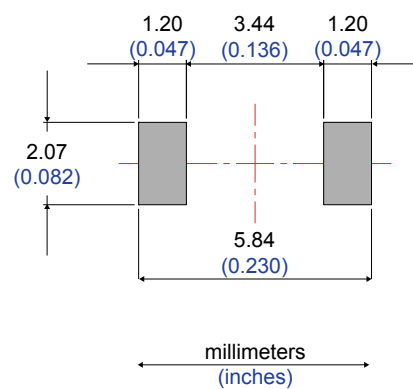



## 2.2 SMB package information

- Epoxy meets UL94, V0
- Lead-free package

Figure 20. SMB package outline

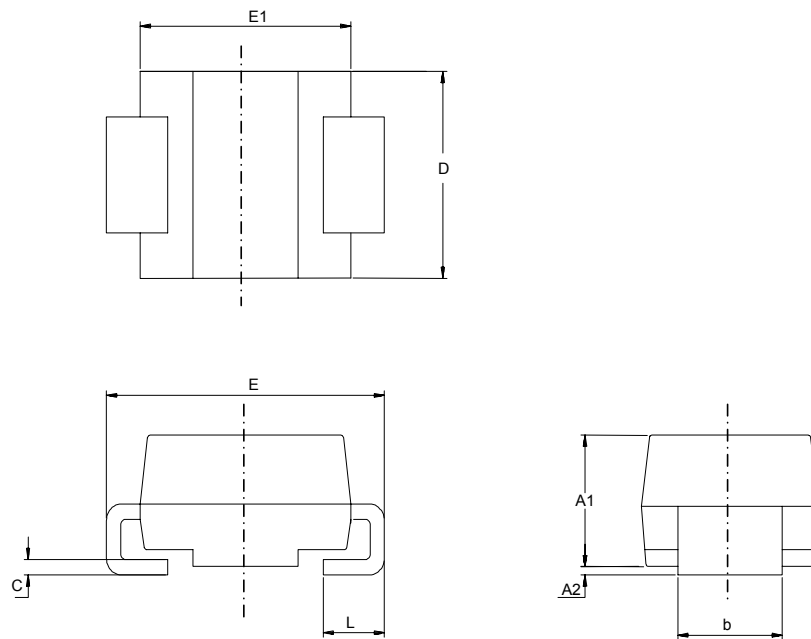
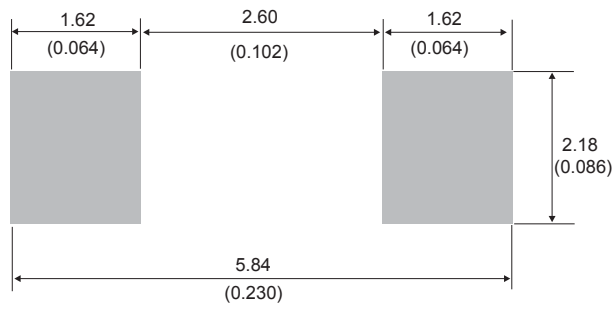

Table 5. SMB package mechanical data

Ref.	Dimensions			
	Millimeters		Inches (for reference only)	
	Min.	Max.	Min.	Max.
A1	1.90	2.45	0.074	0.097
A2	0.05	0.20	0.001	0.008
b	1.95	2.20	0.076	0.087
c	0.15	0.40	0.005	0.016
D	3.30	3.95	0.129	0.156
E	5.10	5.60	0.200	0.221
E1	4.05	4.60	0.159	0.182
L	0.75	1.50	0.029	0.060

**Figure 21. SMB recommended footprint**



### 2.3 SMB Flat package information

- Epoxy meets UL94, V0
- Lead-free package

Figure 22. SMB Flat package outline

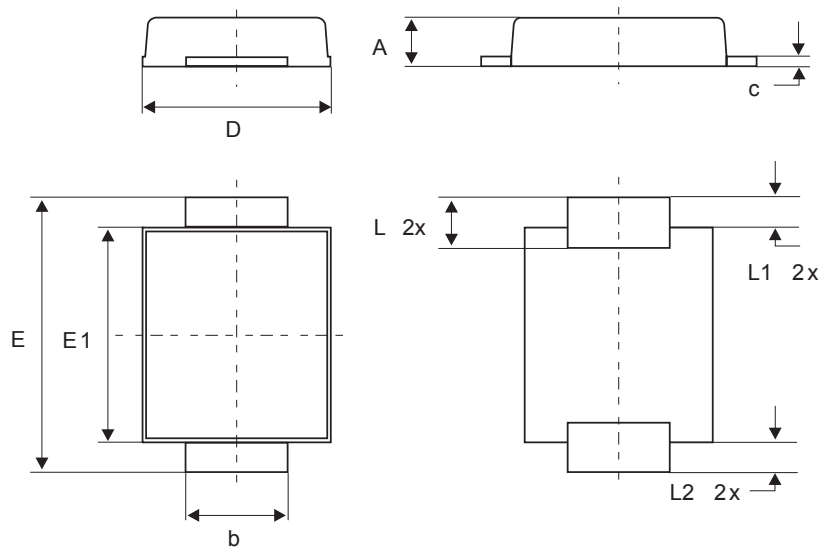
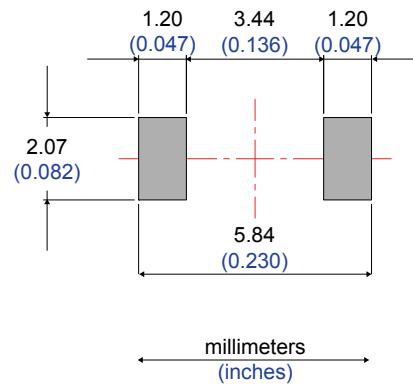

Table 6. SMB Flat mechanical data

Ref.	Dimensions					
	Millimeters			Inches		
	Min.	Typ.	Max.	Min.	Typ.	Max.
A	0.90		1.10	0.035		0.044
b	1.95		2.20	0.076		0.087
c	0.15		0.40	0.005		0.016
D	3.30		3.95	0.129		0.156
E	5.10		5.60	0.200		0.221
E1	4.05		4.60	0.159		0.182
L	0.75		1.50	0.029		0.060
L1		0.40			0.016	
L2		0.60			0.024	

**Figure 23. Footprint recommendations, dimensions in mm (inches)**



## 2.4 DO-201AD package information

- Epoxy meets UL 94, V0

Figure 24. DO-201AD package outline

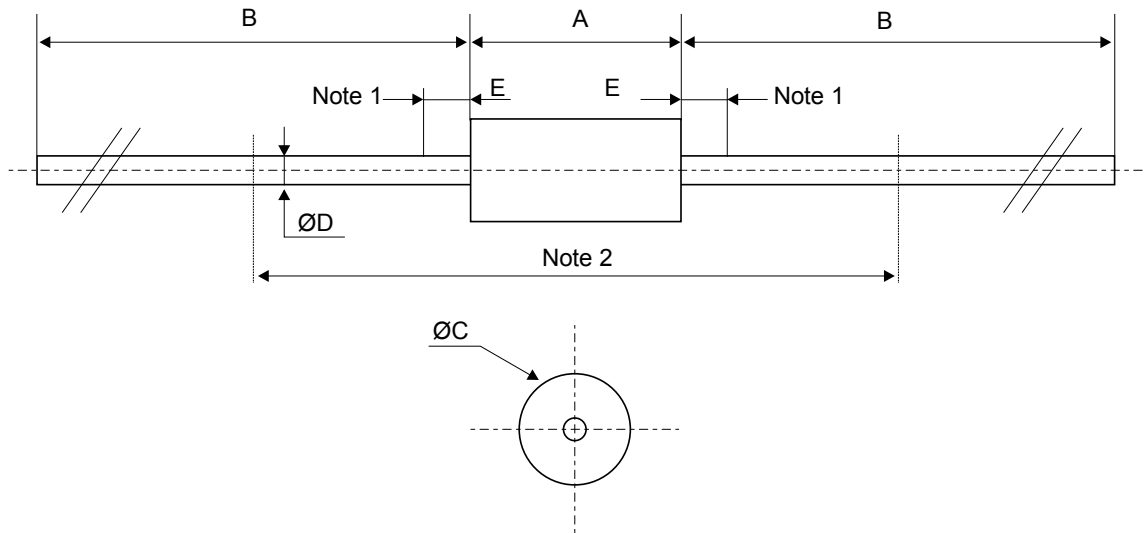

Table 7. DO-201AD package mechanical data

Ref.	Dimensions					
	Millimeters			Inches (for reference only)		
	Min.	Typ.	Max.	Min.	Typ.	Max.
A		-	9.50		-	0.374
B	25.40	-		1.000	-	
C		-	5.30		-	0.209
D <sup>(1)</sup>		-	1.30		-	0.051
E		-	1.25		-	0.049
Note 2 <sup>(2)</sup>	15.00			0.590		

- The lead diameter  $D$  is not controlled over zone  $E$
- The minimum length, which must stay straight between the right angles after bending, is 15 mm (0.59")

## 2.5 DO-15 package information

- Epoxy meets UL 94, V0

Figure 25. DO-15 package outline

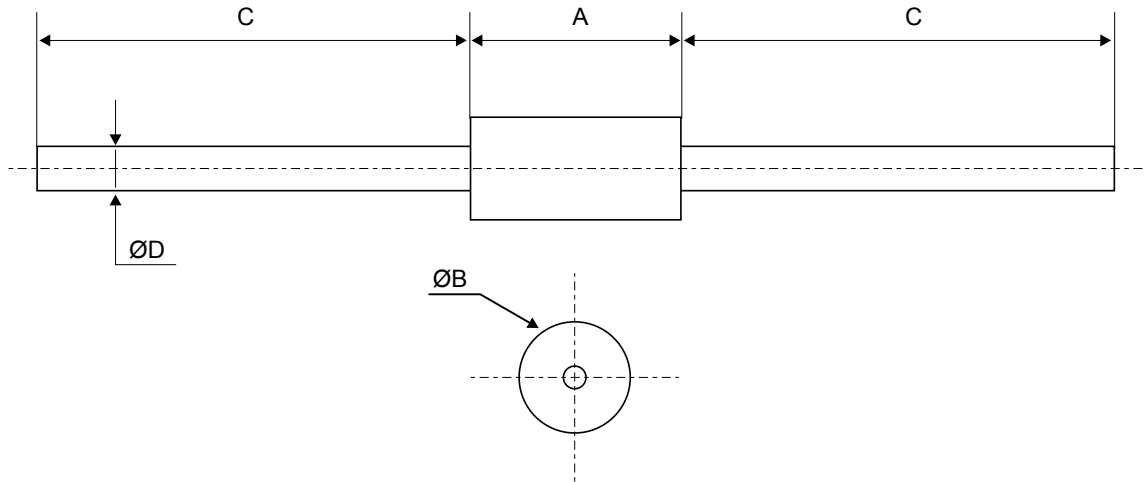

Table 8. DO-15 package mechanical data

Ref.	Dimensions					
	Millimeters			Inches (for reference only)		
	Min.	Typ.	Max.	Min.	Typ.	Max.
A	6.05	-	6.75	0.238	-	0.266
B	2.95	-	3.53	0.116	-	0.139
C	26.00	-	31.00	1.024	-	1.220
D	0.71	-	0.88	0.028	-	0.0035

### 3 Ordering information

**Table 9. Ordering information**

Order code	Marking	Package	Weight	Base qty.	Delivery mode
STPS3L60UFN	B36	SMB Flat Notch	0.056 g	5000	Tape and reel
STPS3L60U	G36	SMB	0.107 g	2500	Tape and reel
STPS3L60UF	FG36	SMB Flat	0.050 g	5000	Tape and reel
STPS3L60RL	STPS3L60	DO-201AD	1.12 g	1900	Tape and reel
STPS3L60Q	STPS3L60	DO-15	0.04 g	1000	Ammopack
STPS3L60QRL	STPS3L60	DO-15		6000	Tape and reel

## Revision history

**Table 10. Document revision history**

Date	Version	Changes
July-2003	5A	Previous issue.
12-Jun-2009	6	Reformatted to current standards. Added SMBflat package. Added ECOPACK statement. Added cathode band graphics.
31-Jan-2020	7	Added <a href="#">Section 2.1 SMB Flat Notch package information</a> .



**IMPORTANT NOTICE – PLEASE READ CAREFULLY**

STMicroelectronics NV and its subsidiaries (“ST”) reserve the right to make changes, corrections, enhancements, modifications, and improvements to ST products and/or to this document at any time without notice. Purchasers should obtain the latest relevant information on ST products before placing orders. ST products are sold pursuant to ST’s terms and conditions of sale in place at the time of order acknowledgement.

Purchasers are solely responsible for the choice, selection, and use of ST products and ST assumes no liability for application assistance or the design of Purchasers’ products.

No license, express or implied, to any intellectual property right is granted by ST herein.

Resale of ST products with provisions different from the information set forth herein shall void any warranty granted by ST for such product.

ST and the ST logo are trademarks of ST. For additional information about ST trademarks, please refer to [www.st.com/trademarks](http://www.st.com/trademarks). All other product or service names are the property of their respective owners.

Information in this document supersedes and replaces information previously supplied in any prior versions of this document.

© 2020 STMicroelectronics – All rights reserved

单击下面可查看定价，库存，交付和生命周期等信息

[>>STMicro\(意法半导体\)](#)