

800 V and 600 V, 25 A standard and Snubberless Triacs

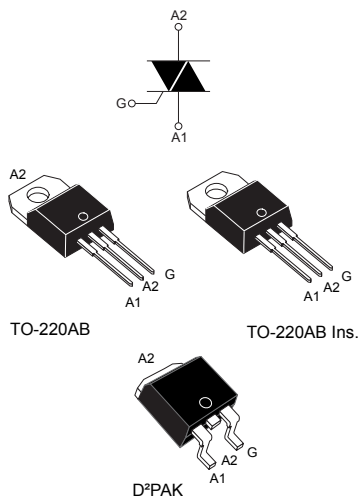

Features

- High current 25 A RMS current Triac
- Low thermal resistance
- High commutation (4 quadrants) or very high commutation (3 quadrants) capability
- BTA series UL1557 recognized components (file ref: 81734)
- RoHS (2002/95/EC) compliant packages
- UL-94, V0 flammability package resin compliance

Applications

- On/off function in static relays, heating regulation, induction motor starting circuits
- Phase control operations in light dimmers and motor speed controllers

Description

Available either in through-hole or surface-mount packages, the BTA24, BTB24 and T25 are suitable for general purpose AC switching.



Product status link	
BTA24	TO-220AB insulated package
BTB24	TO-220AB un-insulated package
T25	D ² PAK package

Product summary			
	BTA24	BTB24	T25
$I_{T(RMS)}$	25 A		
V_{DRM}/V_{RRM}	600 V and 800 V		
I_{GT} Snubberless	35 / 50 mA	35 mA	
I_{GT} standard		50 mA	

1 Characteristics

Table 1. Absolute maximum ratings

Symbol	Parameters		Value	Unit		
$I_{T(RMS)}$	RMS on-state current (full sine wave)	D ² PAK / TO-220AB	$T_c = 100\text{ }^\circ\text{C}$	25	A	
		TO-220AB Ins.	$T_c = 75\text{ }^\circ\text{C}$			
I_{TSM}	Non repetitive surge peak on-state current (full cycle, T_j initial = 25 °C)	f = 60 Hz	$t_p = 16,7\text{ ms}$	260	A	
		f = 50 Hz	$t_p = 20\text{ ms}$	250		
I^2t	I^2t value for fusing	$t_p = 10\text{ ms}$		340	A ² s	
di/dt	Critical rate of rise of on-state current $I_G = 2 \times I_{GT}$, $t_r \leq 100\text{ ns}$	f = 120 Hz	$T_j = 125\text{ }^\circ\text{C}$	50	A/ μ s	
V_{DSM} , V_{RSM}	Non repetitive surge peak off-state voltage	$t_p = 10\text{ ms}$	$T_j = 25\text{ }^\circ\text{C}$	V_{DRM} , $V_{RRM} + 100$	V	
V_{DRM} , V_{RRM}	Repetitive peak off-state voltage	$T_j = 25\text{ }^\circ\text{C}$		600 or 800	V	
I_{GM}	Peak gate current	$t_p = 20\text{ }\mu\text{s}$	$T_j = 125\text{ }^\circ\text{C}$	4	A	
$P_{G(AV)}$	Average gate power dissipation	$T_j = 125\text{ }^\circ\text{C}$		1	W	
T_{stg}	Storage junction temperature range				-40 to +150	°C
T_j	Operating junction temperature range				-40 to +125	°C
T_L	Maximum lead temperature for soldering during 10 s				260	°C
V_{INS}	Insulation RMS voltage, 1 minute				2.5	kV

Table 2. Electrical characteristics ($T_j = 25\text{ }^\circ\text{C}$, unless otherwise specified) - Snubberless (3 quadrants) T25, BTA24-XXXXW, BTB24-XXXXW

Symbol	Parameters	Quadrant		T25	BTA/BTB		Unit
				T2535	CW	BW	
$I_{GT}^{(1)}$	$V_D = 12\text{ V}$, $R_L = 33\text{ }\Omega$	I - II - III	Max.	35	35	50	mA
V_{GT}		I - II - III	Max.	1.3			V
V_{GD}	$V_D = V_{DRM}$, $R_L = 3.3\text{ k}\Omega$, $T_j = 125\text{ }^\circ\text{C}$	I - II - III	Min.	0.2			V
$I_H^{(2)}$	$I_T = 500\text{ mA}$		Max.	50	50	75	mA
I_L	$I_G = 1.2 I_{GT}$	I - III	Max.	70	70	80	mA
		II	Max.	80	80	100	
dV/dt ⁽²⁾	$V_D = 67\% V_{DRM}$ gate open, $T_j = 125\text{ }^\circ\text{C}$		Min.	500	500	1000	V/ μ s
(di/dt) ⁽²⁾	Without snubber		Min.	13	13	22	A/ms

1. Minimum I_{GT} is guaranteed at 5 % of I_{GT} max.

2. For both polarities of A2 referenced to A1

Table 3. Electrical characteristics ($T_j = 25\text{ }^\circ\text{C}$, unless otherwise specified) - standard (4 quadrants) BTB24-800B, BTB24-600B

Symbol	Parameters	Quadrant		Value	Unit
$I_{GT}^{(1)}$	$V_D = 12\text{ V}, R_L = 33\ \Omega$	I - II - III	Max.	50	mA
		IV		100	
V_{GT}		All	Max.	1.3	V
V_{GD}	$V_D = V_{DRM}, R_L = 3.3\text{ k}\Omega, T_j = 125\text{ }^\circ\text{C}$	All	Min.	0.2	V
$I_H^{(2)}$	$I_T = 500\text{ mA}$		Max.	80	mA
I_L	$I_G = 1.2\ I_{GT}$	I - III - IV	Max.	70	mA
		II	Max.	160	
$dV/dt^{(2)}$	$V_D = 67\% V_{DRM}$ gate open, $T_j = 125\text{ }^\circ\text{C}$		Min.	500	V/ μs
$(dI/dt)_c^{(2)}$	$(dI/dt)_c = 13.3\text{ A/ms}, T_j = 125\text{ }^\circ\text{C}$		Min.	10	V/ μs

1. Minimum I_{GT} is guaranteed at 5 % of I_{GT} max.
2. For both polarities of A2 referenced to A1

Table 4. Static electrical characteristics

Symbol	Test conditions	T_j		Value	Unit
$V_{TM}^{(1)}$	$I_{TM} = 35\text{ A}, t_p = 380\ \mu\text{s}$	$25\text{ }^\circ\text{C}$	Max.	1.55	V
$V_{TO}^{(1)}$	threshold on-state voltage	$125\text{ }^\circ\text{C}$	Max.	0.85	V
$R_D^{(1)}$	Dynamic resistance	$125\text{ }^\circ\text{C}$	Max.	16	m Ω
I_{DRM}/I_{RRM}	$V_T = V_{DRM}, V_T = V_{RRM}$	$25\text{ }^\circ\text{C}$	Max.	5	μA
		$125\text{ }^\circ\text{C}$		3	mA

1. For both polarities of A2 referenced to A1

Table 5. Thermal resistance

Symbol	Parameters			Value	Unit
$R_{th(j-c)}$	Junction to case (AC)	D ² PAK / TO-220AB	Max.	0.8	$^\circ\text{C/W}$
		TO-220AB insulated		1.7	
$R_{th(j-a)}$	Junction to ambient, $S^{(1)} = 2.5\text{ cm}^2$	D ² PAK	Typ.	45	
	Junction to ambient	TO-220AB / TO-220AB insulated		60	

1. S = Copper surface under tab.

1.1 Characteristics (curves)

Figure 1. Maximum power dissipation versus on-state RMS current (full cycle)

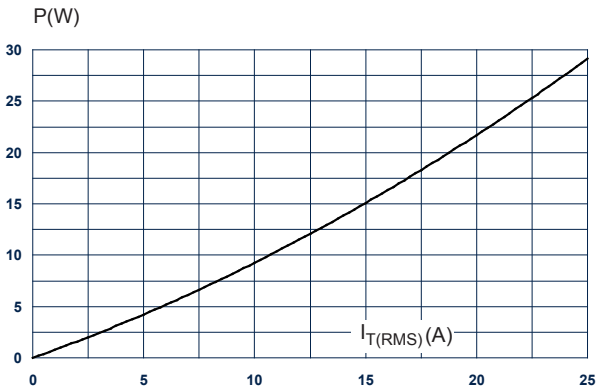

Figure 2. RMS on-state current versus case temperature (full cycle)

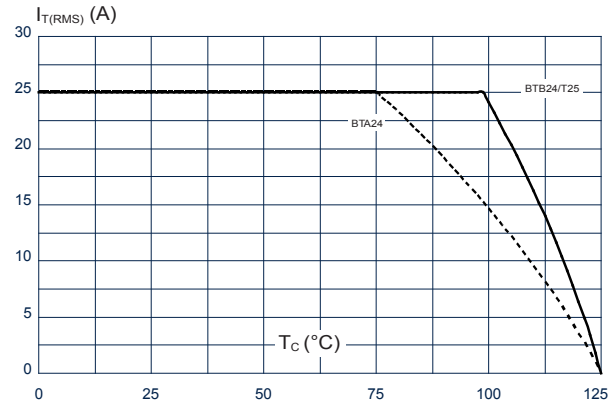

Figure 3. RMS on-state current versus ambient temperature (full cycle) D²PAK

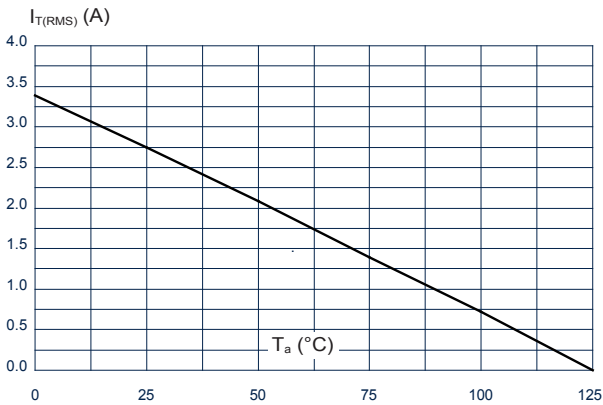

Figure 4. Relative variation of thermal impedance versus pulse duration

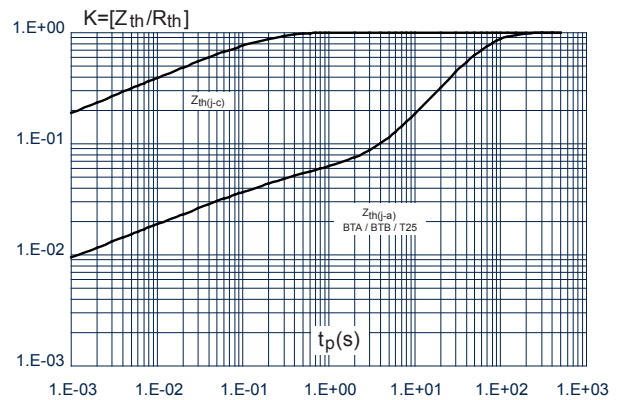

Figure 5. On-state characteristics (maximum values)

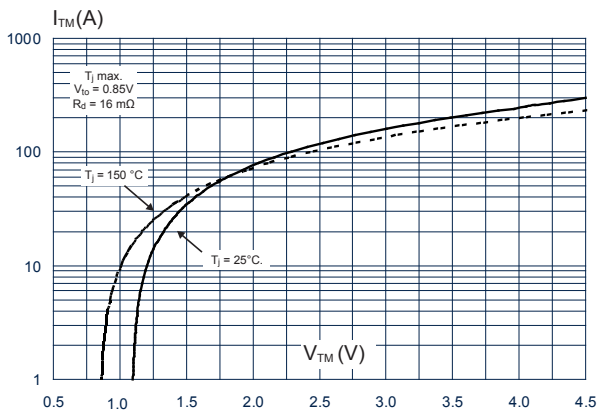

Figure 6. Surge peak on-state current versus number of cycles

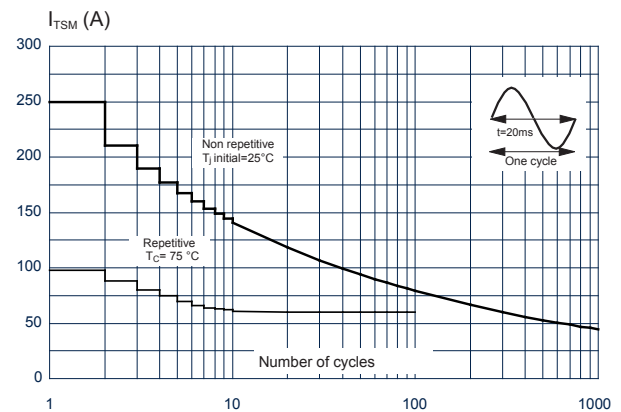

Figure 7. Non-repetitive surge peak on-state current for a sinusoidal pulse with width $t_p < 10$ ms

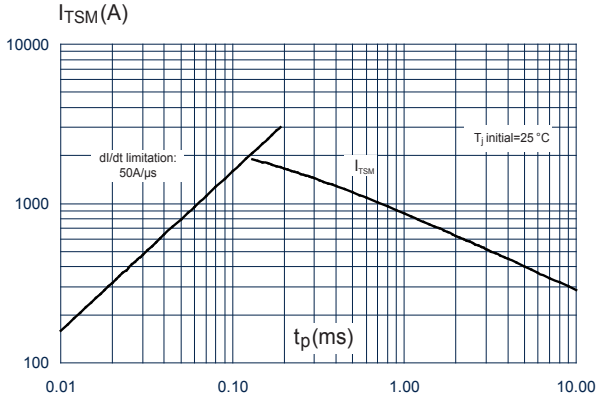

Figure 8. Relative variation of gate trigger current, holding and latching current versus junction temperature

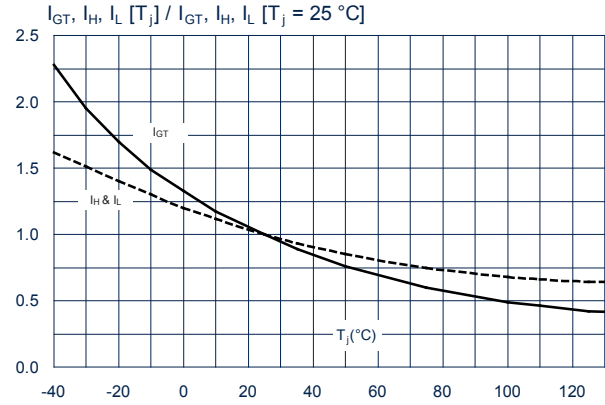

Figure 9. Relative variation of critical rate of decrease of main current versus (dV/dt)c (typical values)

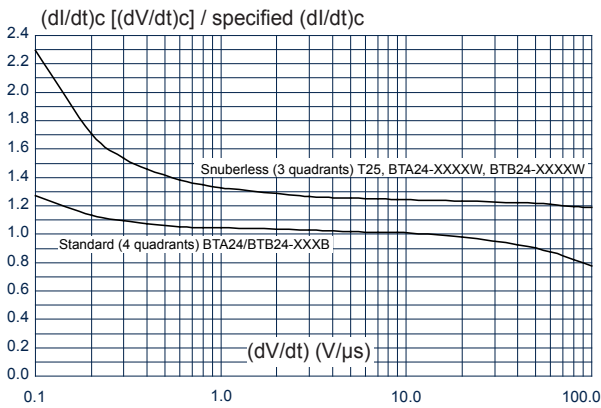

Figure 10. Relative variation of critical rate of decrease of main current versus junction temperature (typical values)

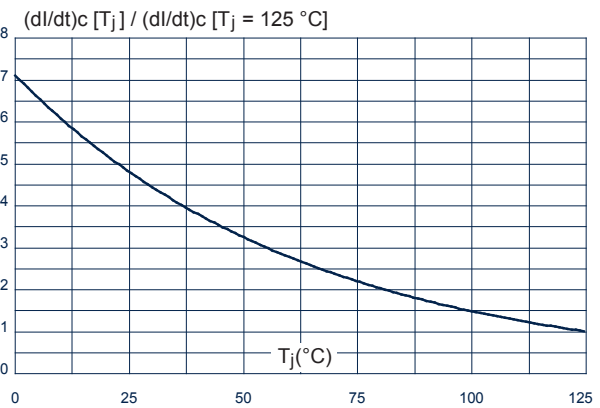
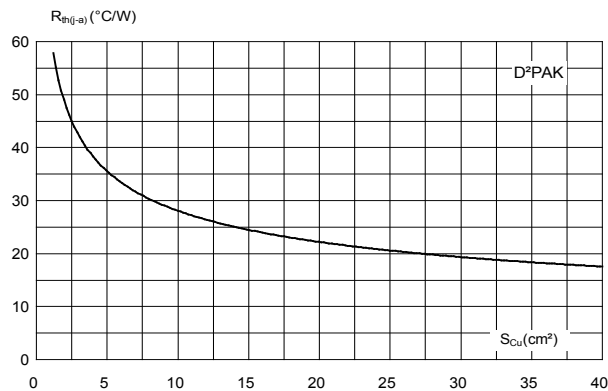

Figure 11. D²PAK thermal resistance junction to ambient versus copper surface under tab



2 Package information

In order to meet environmental requirements, ST offers these devices in different grades of **ECOPACK** packages, depending on their level of environmental compliance. ECOPACK specifications, grade definitions and product status are available at: www.st.com. ECOPACK is an ST trademark.

2.1 TO-220AB package information

- Molding compound resin is halogen free and meets UL94 flammability standard, level V0
- Lead-free plating package leads
- Recommended torque: 0.4 to 0.6 N·m

Figure 12. TO-220AB package outline

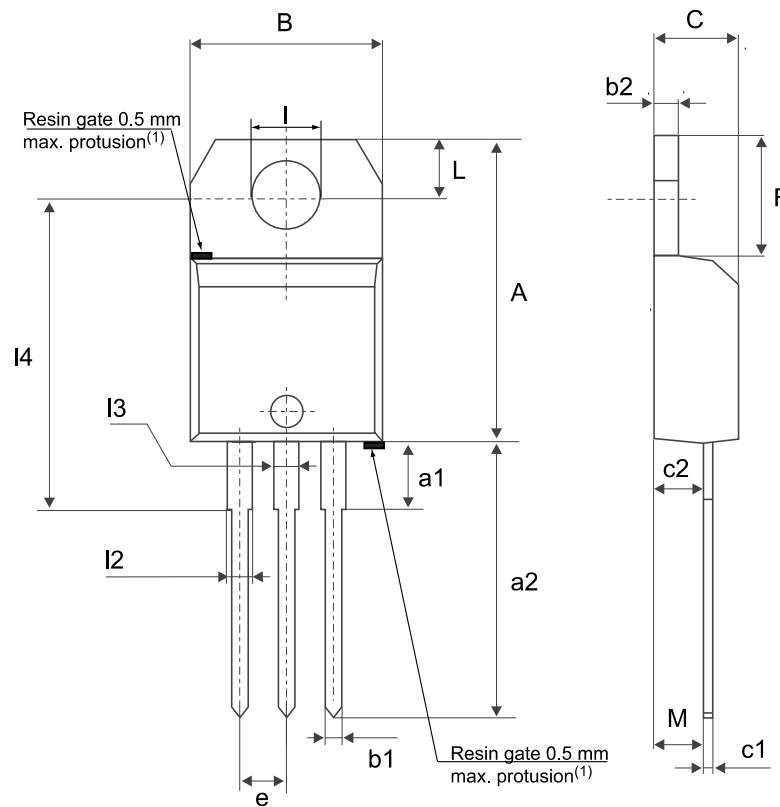

(1) Resin gate position accepted in one of the two positions or in the symmetrical opposites.

Table 6. TO-220AB package mechanical data

Ref.	Dimensions					
	Millimeters			Inches ⁽¹⁾		
	Min.	Typ.	Max.	Min.	Typ.	Max.
A	15.20		15.90	0.5984		0.6260
a1		3.75			0.1476	
a2	13.00		14.00	0.5118		0.5512
B	10.00		10.40	0.3937		0.4094
b1	0.61		0.88	0.0240		0.0346
b2	1.23		1.32	0.0484		0.0520
C	4.40		4.60	0.1732		0.1811
c1	0.49		0.70	0.0193		0.0276
c2	2.40		2.72	0.0945		0.1071
e	2.40		2.70	0.0945		0.1063
F	6.20		6.60	0.2441		0.2598
I	3.73		3.88	0.1469		0.1528
L	2.65		2.95	0.1043		0.1161
I2	1.14		1.70	0.0449		0.0669
I3	1.14		1.70	0.0449		0.0669
I4	15.80	16.40	16.80	0.6220	0.6457	0.6614
M		2.6			0.1024	

1. Inch dimensions are for reference only.

2.2 D²PAK package information

- ECOPACK2 compliant
- Lead-free package leads finishing
- Molding compound resin is halogen-free and meets UL94 flammability standard level V0

Figure 13. D²PAK package outline

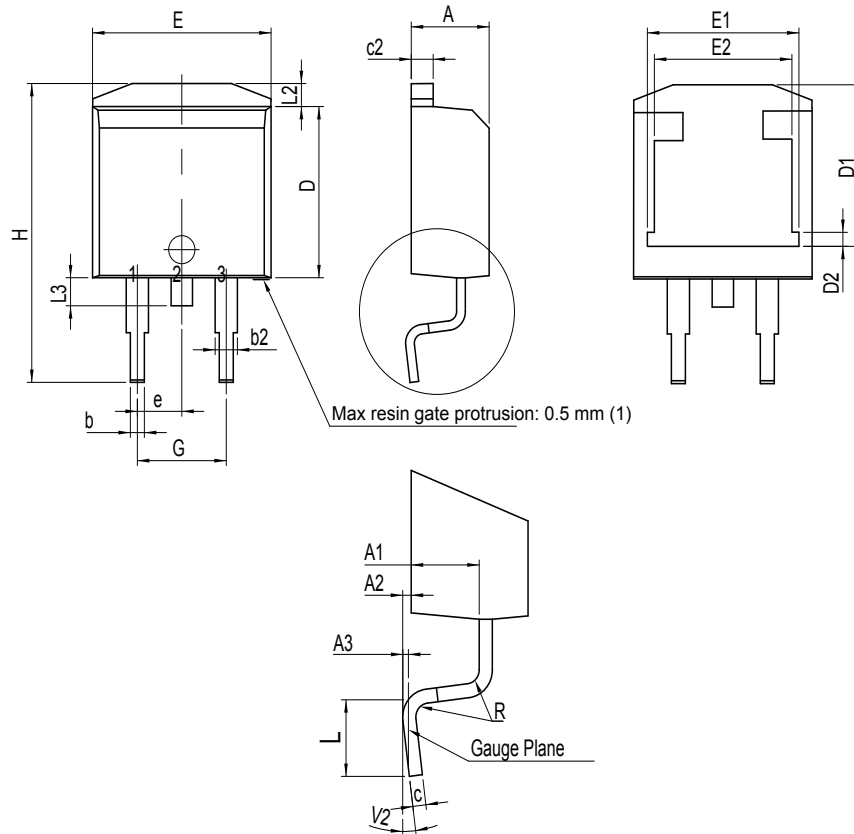

(1) Resin gate is accepted in each of position shown on the drawing, or their symmetrical.

Table 7. D²PAK package mechanical data

Ref.	Dimensions					
	Millimeters			Inches ⁽¹⁾		
	Min.	Typ.	Max.	Min.	Typ.	Max.
A	4.30		4.60	0.1693		0.1811
A1	2.49		2.69	0.0980		0.1059
A2	0.03		0.23	0.0012		0.0091
A3		0.25			0.0098	
b	0.70		0.93	0.0276		0.0366
b2	1.25		1.7	0.0492		0.0669
c	0.45		0.60	0.0177		0.0236
c2	1.21		1.36	0.0476		0.0535
D	8.95		9.35	0.3524		0.3681
D1	7.50		8.00	0.2953		0.3150
D2	1.30		1.70	0.0512		0.0669
e	2.54			0.10000		
E	10.00		10.28	0.3937		0.4047
E1	8.30		8.70	0.3268		0.3425
E2	6.85		7.25	0.2697		0.2854
G	4.88		5.28	0.1921		0.2079
H	15		15.85	0.5906		0.6240
L	1.78		2.28	0.0701		0.0898
L2	1.19		1.40	0.0468		0.0551
L3	1.40		1.75	0.0551		0.0689
R		0.40			0.0157	
V2 ⁽²⁾	0°		8°	0°		8°

1. Dimensions in inches are given for reference only

2. Degrees

Figure 14. D²PAK recommended footprint (dimensions are in mm)

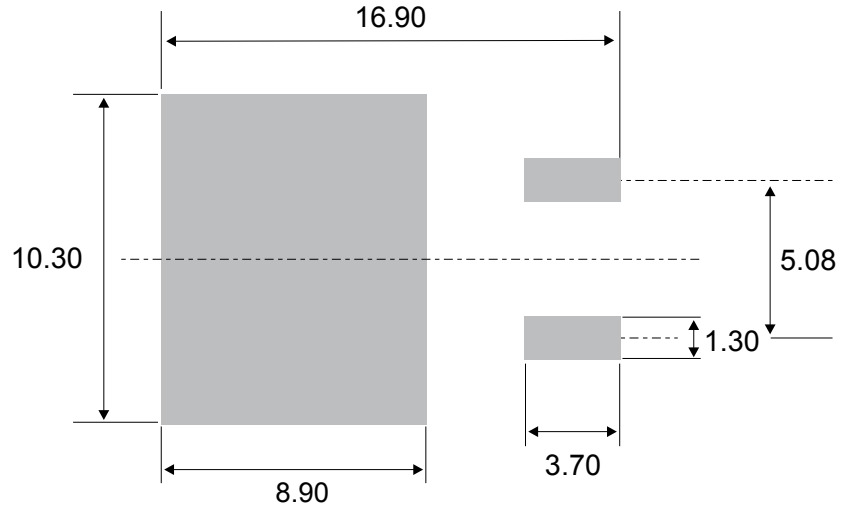
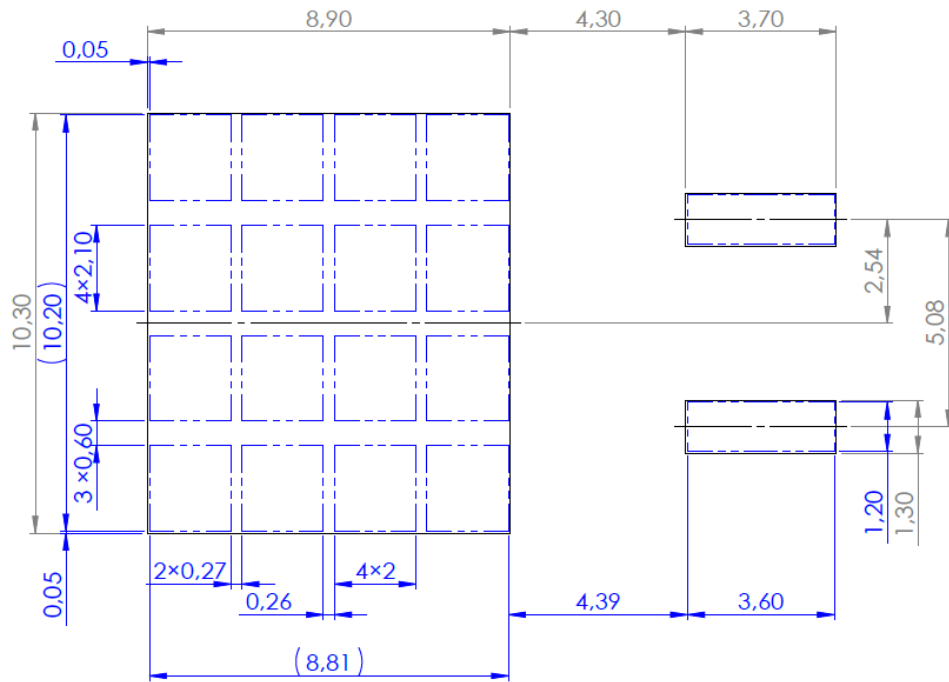

Figure 15. D²PAK stencil definitions (dimensions are in mm)



3 Ordering information

Figure 16. Ordering information scheme (BTA24 and BTB24 series)

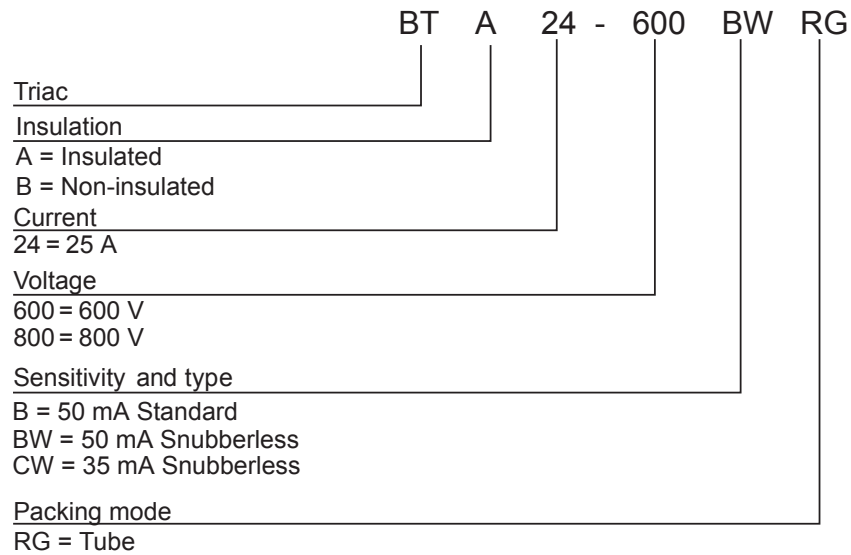

Figure 17. Ordering information scheme (T25 series)

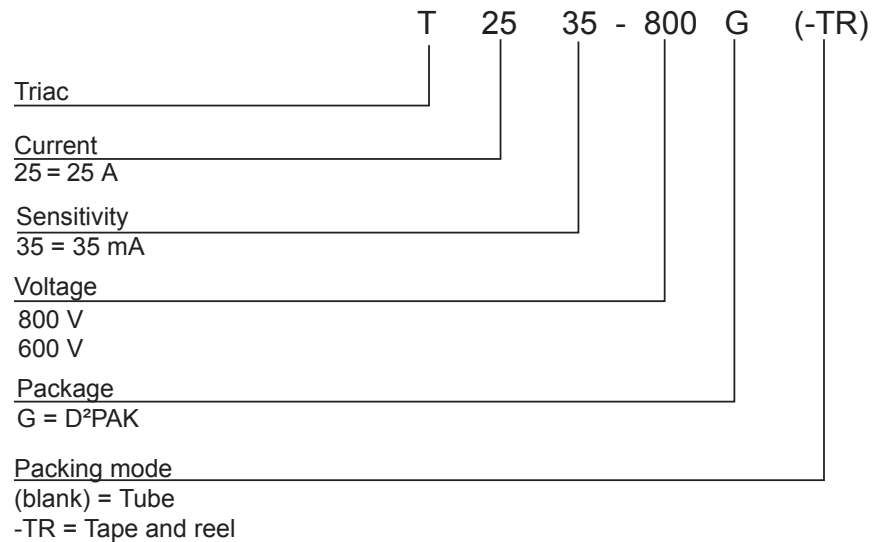

Table 8. Ordering information

Order code	Marking	Package	Weight	Base qty.	Delivery mode
BTA24-600BWRG	BTA24 600BW	TO-220AB insulated	2.3 g	50	Tube
BTA24-600CWRG	BTA24 600CW				
BTA24-800BWRG	BTA24 800BW				
BTA24-800CWRG	BTA24 800CW				
BTB24-600BRG	BTB24 600B	TO-220AB			
BTB24-600BWRG	BTB24 600BW				
BTB24-600CWRG	BTB24 600CW				
BTB24-800BRG	BTB24 800B				
BTB24-800BWRG	BTB24 800BW				
BTB24-800CWRG	BTB24 800CW				
T2535-600G	T2535 600G	D ² PAK	1.5 g	50	Tube
T2535-600G-TR	T2535 600G			2500	Tape and reel
T2535-800G	T2535 800G			50	Tube
T2535-800G-TR	T2535 800G			2500	Tape and reel

Revision history

Table 9. Document revision history

Date	Revision	Changes
Oct-2002	6A	Previous update.
13-Feb-2006	7	TO-220AB delivery mode changed from bulk to tube. ECOPACK statement added.
31-May-2006	8	Reformatted to current standard. Tc in figure 3 changed to Tamb
31-Jul-2006	9	Typing error corrected on page 1 (BTB124 instead of BTB24)
05-Jul-2007	10	Added BTB26-600BRG. Restructured cover page and section 2: Ordering information scheme on page 6 to simplify product selection. Thermal resistance values updated in Table 6 and Figure 2. Graphic for I2t updated in Figure 7.
28-Jul-2021	11	Removed RD91, TOP3 insulated and TOP3 package information. Put in separate specification. Minor text changes.
29-Sep-2021	12	Updated Table 2 .

IMPORTANT NOTICE – PLEASE READ CAREFULLY

STMicroelectronics NV and its subsidiaries (“ST”) reserve the right to make changes, corrections, enhancements, modifications, and improvements to ST products and/or to this document at any time without notice. Purchasers should obtain the latest relevant information on ST products before placing orders. ST products are sold pursuant to ST’s terms and conditions of sale in place at the time of order acknowledgement.

Purchasers are solely responsible for the choice, selection, and use of ST products and ST assumes no liability for application assistance or the design of Purchasers’ products.

No license, express or implied, to any intellectual property right is granted by ST herein.

Resale of ST products with provisions different from the information set forth herein shall void any warranty granted by ST for such product.

ST and the ST logo are trademarks of ST. For additional information about ST trademarks, please refer to www.st.com/trademarks. All other product or service names are the property of their respective owners.

Information in this document supersedes and replaces information previously supplied in any prior versions of this document.

© 2021 STMicroelectronics – All rights reserved

单击下面可查看定价，库存，交付和生命周期等信息

[>>STMicro\(意法半导体\)](#)