

Low drop power Schottky rectifier

Datasheet - production data

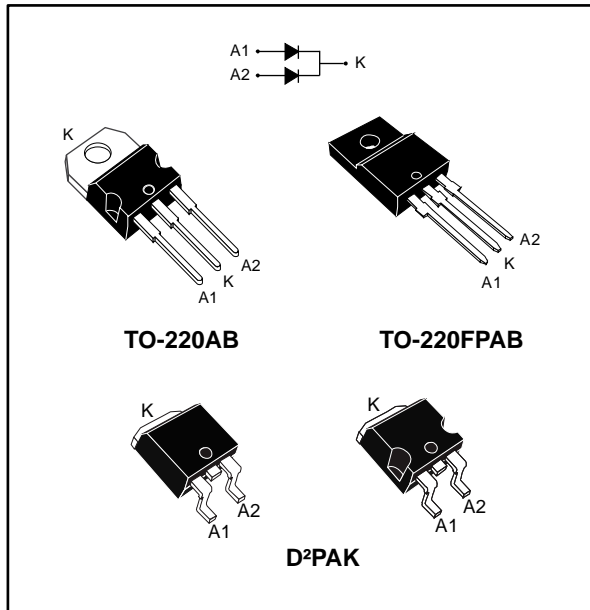

Description

Dual center tap Schottky rectifiers designed for high frequency switched mode power supplies and DC to DC converters.

These devices are intended for use in low voltage, high frequency inverters, free-wheeling and polarity protection applications.

Table 1: Device summary

Symbol	Value
$I_{F(AV)}$	2 x 10 A
V_{RRM}	45 V
V_F (typ.)	0.44 V
T_j (max.)	150 °C

Features

- Low forward voltage drop meaning very small conduction losses
- Low switching losses allowing high frequency operation
- Insulated package: TO-220FPAB
 - Insulating voltage = 2000 V_{RMS} sine
- Avalanche capability specified
- ECOPACK[®]2 compliant component for D²PAK on demand

1 Characteristics

Table 2: Absolute ratings (limiting values, per diode, at 25 °C, unless otherwise specified)

Symbol	Parameter			Value	Unit	
V _{RRM}	Repetitive peak reverse voltage			45	V	
I _{F(RMS)}	Forward rms current			30	A	
I _{F(AV)}	Average forward current δ = 0.5, square wave	TO-220AB / D ² PAK	T _C = 135 °C	Per diode	10	A
			T _C = 130 °C	Per device	20	
		TO-220FPAB	T _C = 115 °C	Per diode	10	
			T _C = 100 °C	Per device	20	
I _{FSM}	Surge non repetitive forward current		t _p = 10 ms sinusoidal	180	A	
P _{ARM}	Repetitive peak avalanche power		t _p = 10 μs, T _j = 125 °C	285	W	
T _{stg}	Storage temperature range			-65 to +150	°C	
T _j	Maximum operating junction temperature ⁽¹⁾			150		

Notes:

⁽¹⁾(dP_{tot}/dT_j) < (1/R_{th(j-a)}) condition to avoid thermal runaway for a diode on its own heatsink.

Table 3: Thermal parameters

Symbol	Parameter		Max. value	Unit	
R _{th(j-c)}	Junction to case	TO-220FPAB	Per diode	4.5	°C/W
			Total	3.5	
		TO-220AB D ² PAK	Per diode	2.2	
			Total	1.3	
R _{th(c)}	Coupling	TO-220FPAB	2.5		
		TO-220AB D ² PAK	0.3		

When the diodes 1 and 2 are used simultaneously:

$$\Delta T_j (\text{diode1}) = P_{(\text{diode1})} \times R_{\text{th(j-c)}} (\text{per diode}) + P_{(\text{diode2})} \times R_{\text{th(c)}}$$



Table 4: Static electrical characteristics (per diode)

Symbol	Parameter	Test conditions		Min.	Typ.	Max.	Unit
$I_R^{(1)}$	Reverse leakage current	$T_j = 25\text{ °C}$	$V_R = V_{RRM}$	-		0.2	mA
		$T_j = 125\text{ °C}$		-	65	130	
$V_F^{(1)}$	Forward voltage drop	$T_j = 25\text{ °C}$	$I_F = 10\text{ A}$	-		0.55	V
		$T_j = 125\text{ °C}$			0.44	0.5	
		$T_j = 25\text{ °C}$	$I_F = 20\text{ A}$	-		0.73	
		$T_j = 125\text{ °C}$		-	0.62	0.72	

Notes:

⁽¹⁾Pulse test: $t_p = 380\text{ }\mu\text{s}$, $\delta < 2\%$

To evaluate the conduction losses, use the following equation:

$$P = 0.28 \times I_{F(AV)} + 0.022 \times I_{F(RMS)}^2$$

1.1 Characteristics (curves)

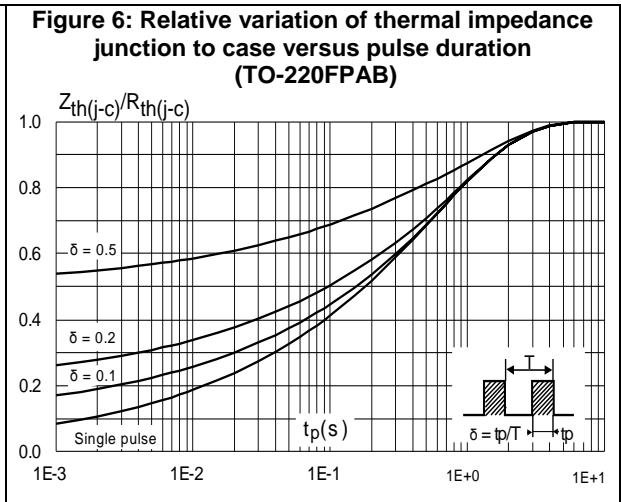
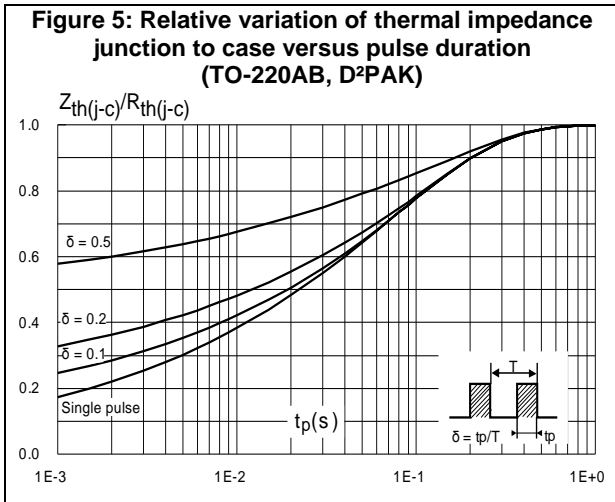
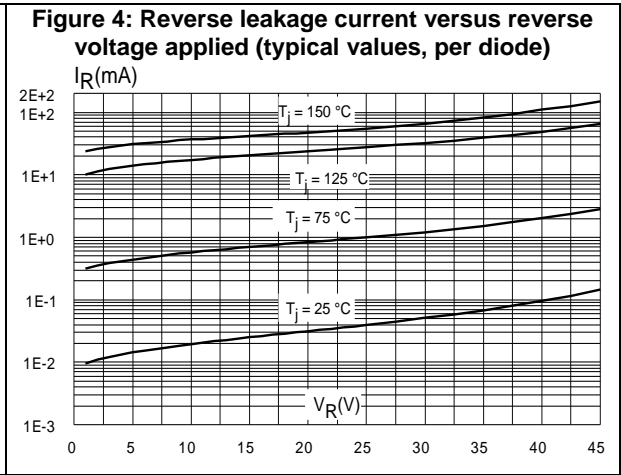
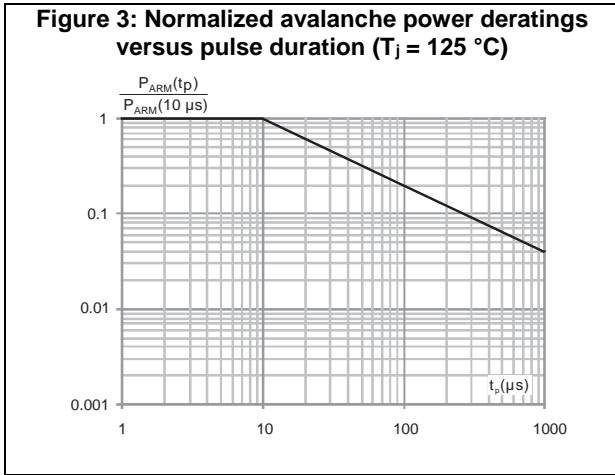
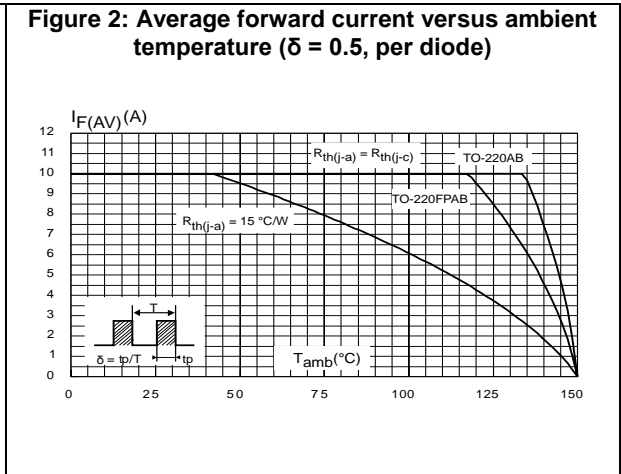
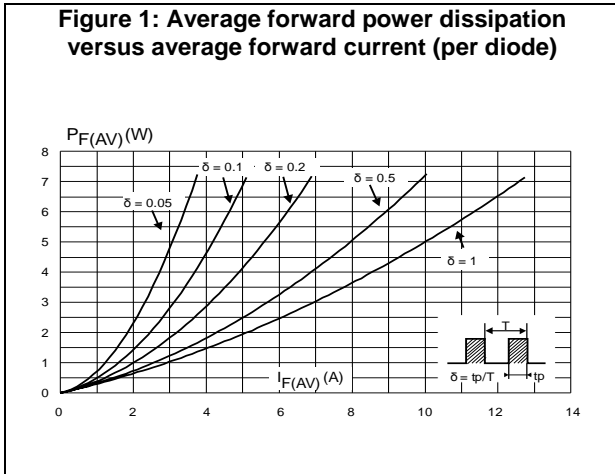

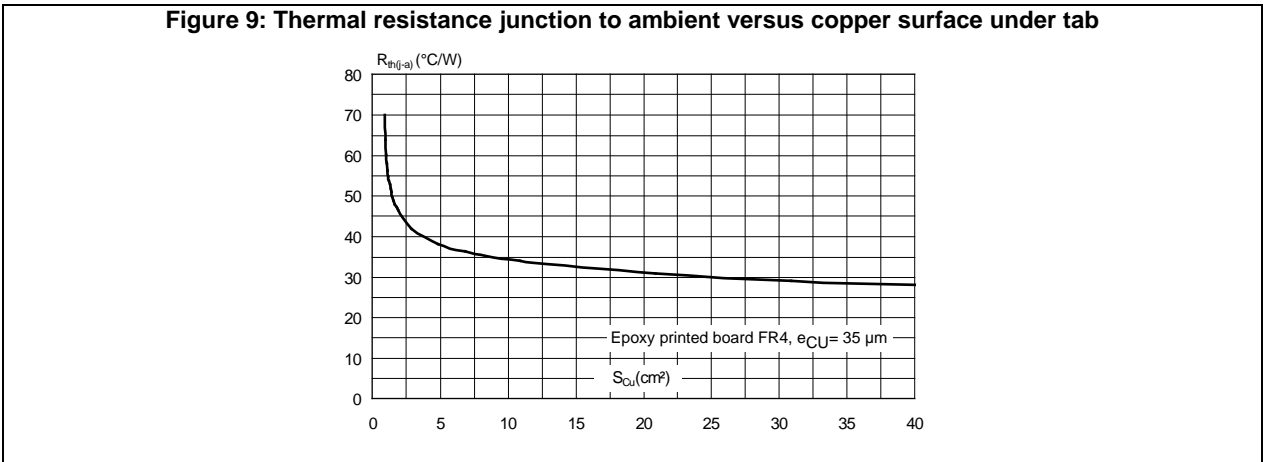
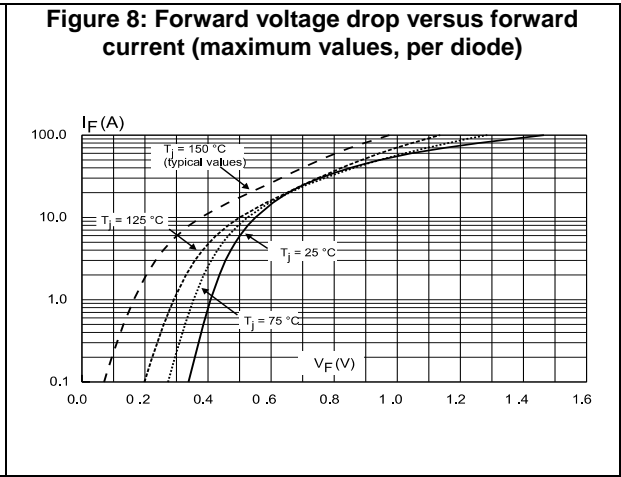
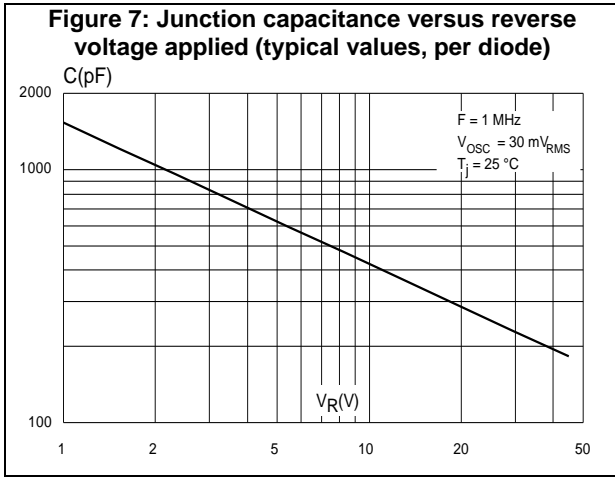

2 Package information

In order to meet environmental requirements, ST offers these devices in different grades of ECOPACK® packages, depending on their level of environmental compliance. ECOPACK® specifications, grade definitions and product status are available at: www.st.com. ECOPACK® is an ST trademark.

- Cooling method: by conduction (C)
- Epoxy meets UL 94, V0
- Recommended torque value: 0.55 N·m for TO-220AB
- Maximum torque value: 0.7 N·m for TO-220AB

2.1 TO-220AB package information

Figure 10: TO-220AB package outline

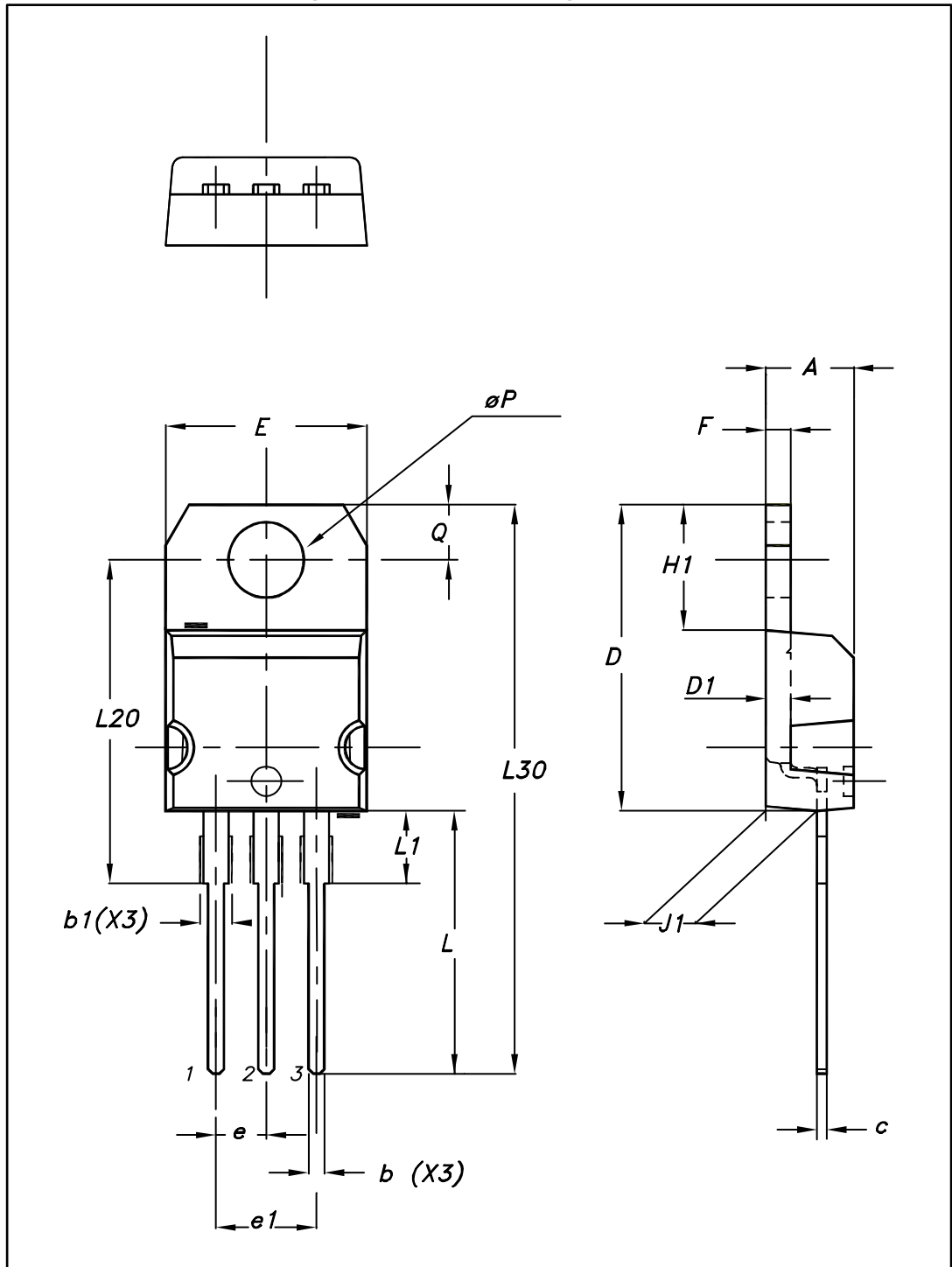

Table 5: TO-220AB package mechanical data

Ref.	Dimensions			
	Millimeters		Inches	
	Min.	Max.	Min.	Max.
A	4.40	4.60	0.173	0.181
b	0.61	0.88	0.240	0.035
b1	1.14	1.70	0.045	0.067
c	0.48	0.70	0.019	0.028
D	15.25	15.75	0.600	0.620
D1	1.27 typ.		0.050 typ.	
E	10.00	10.40	0.394	0.409
e	2.40	2.70	0.094	0.106
e1	4.95	5.15	0.195	0.203
F	1.23	1.32	0.048	0.052
H1	6.20	6.60	0.244	0.260
J1	2.40	2.72	0.094	0.107
L	13.00	14.00	0.512	0.551
L1	3.50	3.93	0.138	0.155
L20	16.40 typ.		0.646 typ.	
L30	28.90 typ.		1.138 typ.	
θP	3.75	3.85	0.148	0.152
Q	2.65	2.95	0.104	0.116

2.2 TO-220FPAB package information

Figure 11: TO-220FPAB package outline

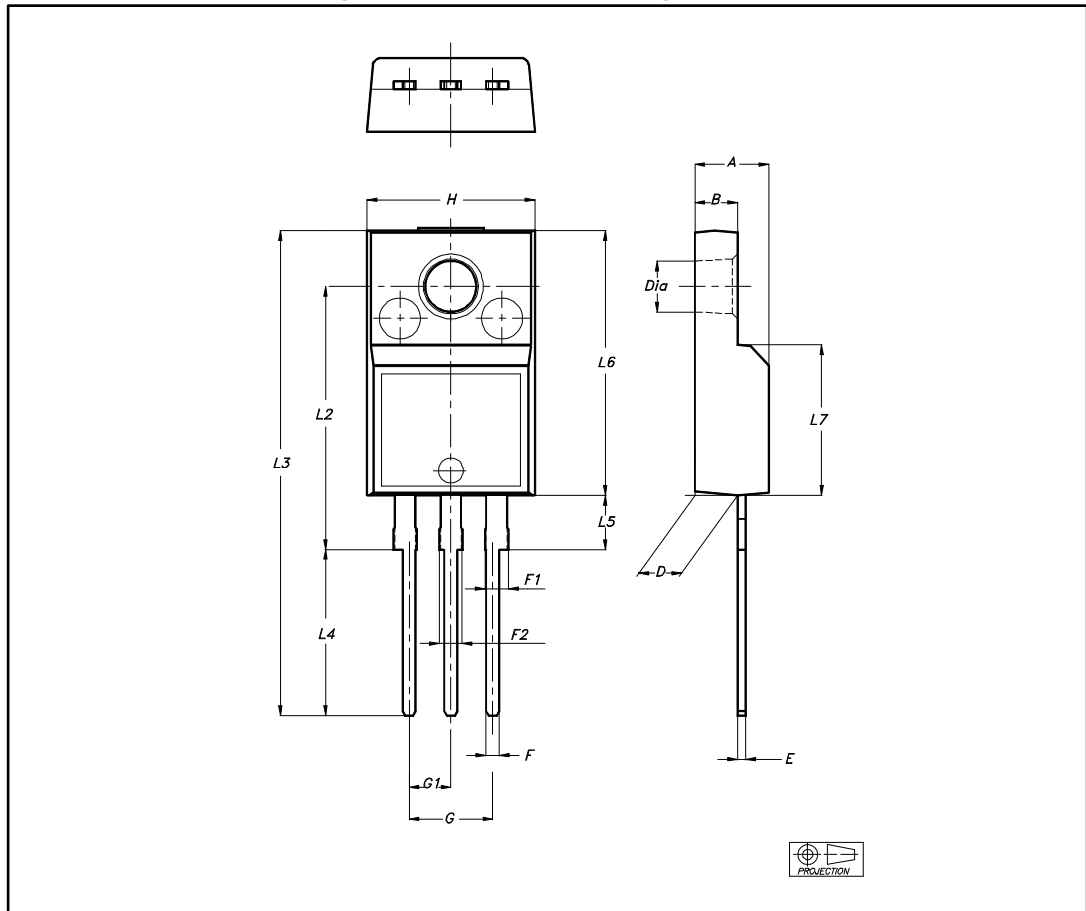
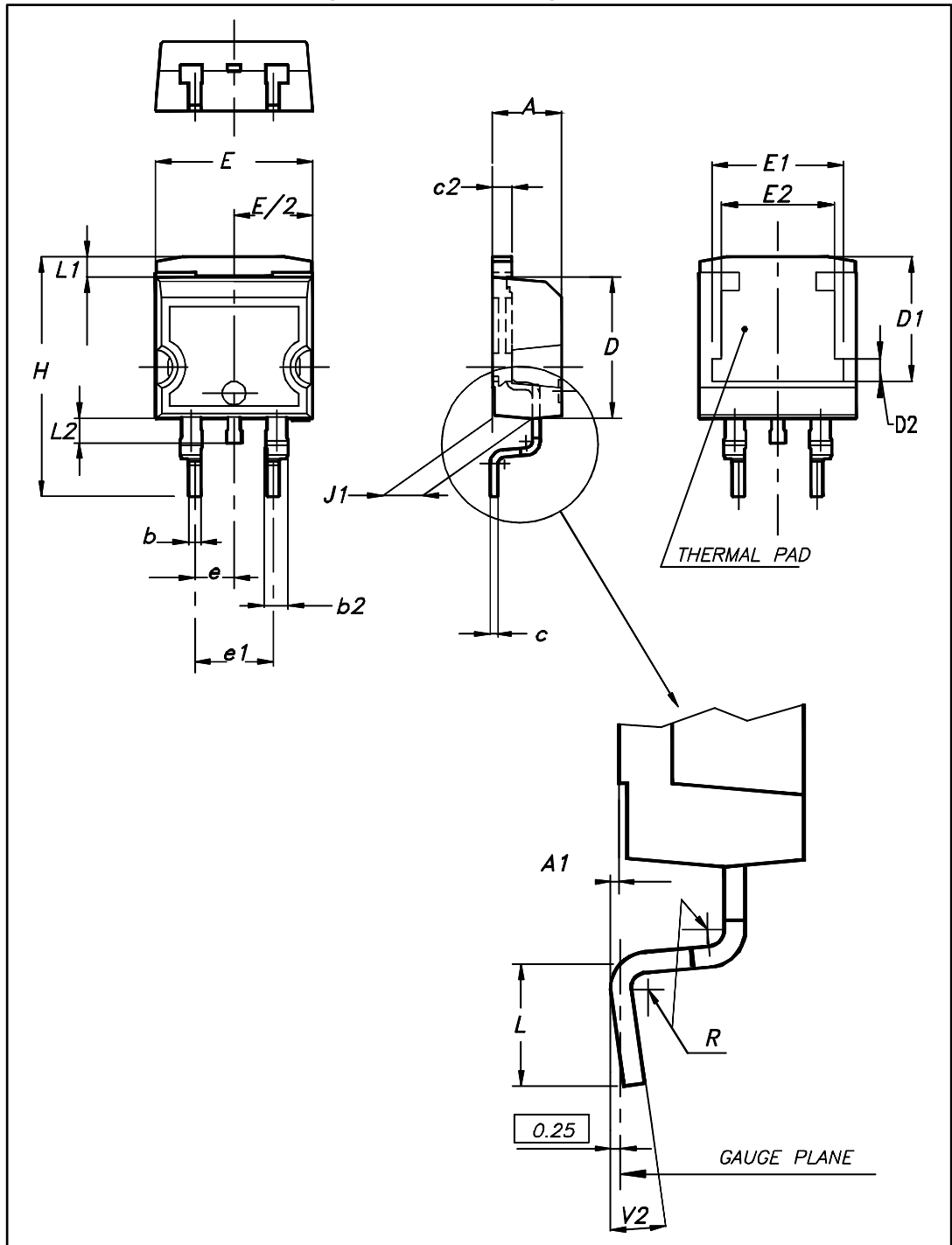

Table 6: TO-220FPAB package mechanical data

Ref.	Dimensions			
	Millimeters		Inches	
	Min.	Max.	Min.	Max.
A	4.40	4.60	0.173	0.181
B	2.5	2.7	0.098	0.106
D	2.5	2.75	0.098	0.108
E	0.45	0.70	0.018	0.028
F	0.75	1	0.030	0.039
F1	1.15	1.70	0.045	0.067
F2	1.15	1.70	0.045	0.067
G	4.95	5.2	0.195	0.205
G1	2.4	2.7	0.094	0.106
H	10	10.4	0.394	0.409
L2	16 typ.		0.63 typ.	
L3	28.60	30.6	1.126	1.205
L4	9.8	10.6	0.386	0.417
L5	2.9	3.6	0.114	0.142
L6	15.9	16.4	0.626	0.646
L7	9	9.3	0.354	0.366
Dia	3	3.2	0.118	0.126

2.3 D²PAK package information

Figure 12: D²PAK package outline



This package drawing may slightly differ from the physical package. However, all the specified dimensions are guaranteed.

Table 7: D²PAK package mechanical data

Ref.	Dimensions			
	Millimeters		Inches	
	Min.	Max.	Min.	Max.
A	4.36	4.60	0.172	0.181
A1	0.00	0.25	0.000	0.010
b	0.70	0.93	0.028	0.037
b2	1.14	1.70	0.045	0.067
c	0.38	0.69	0.015	0.027
c2	1.19	1.36	0.047	0.053
D	8.60	9.35	0.339	0.368
D1	6.90	8.00	0.272	0.311
D2	1.10	1.50	0.043	0.060
E	10.00	10.55	0.394	0.415
E1	8.10	8.90	0.319	0.346
E2	6.85	7.25	0.266	0.282
e	2.54 typ.		0.100	
e1	4.88	5.28	0.190	0.205
H	15.00	15.85	0.591	0.624
J1	2.49	2.90	0.097	0.112
L	1.90	2.79	0.075	0.110
L1	1.27	1.65	0.049	0.065
L2	1.30	1.78	0.050	0.070
R	0.4 typ.		0.015	
V2	0°	8°	0°	8°

Figure 13: D²PAK recommended footprint (dimensions in mm)

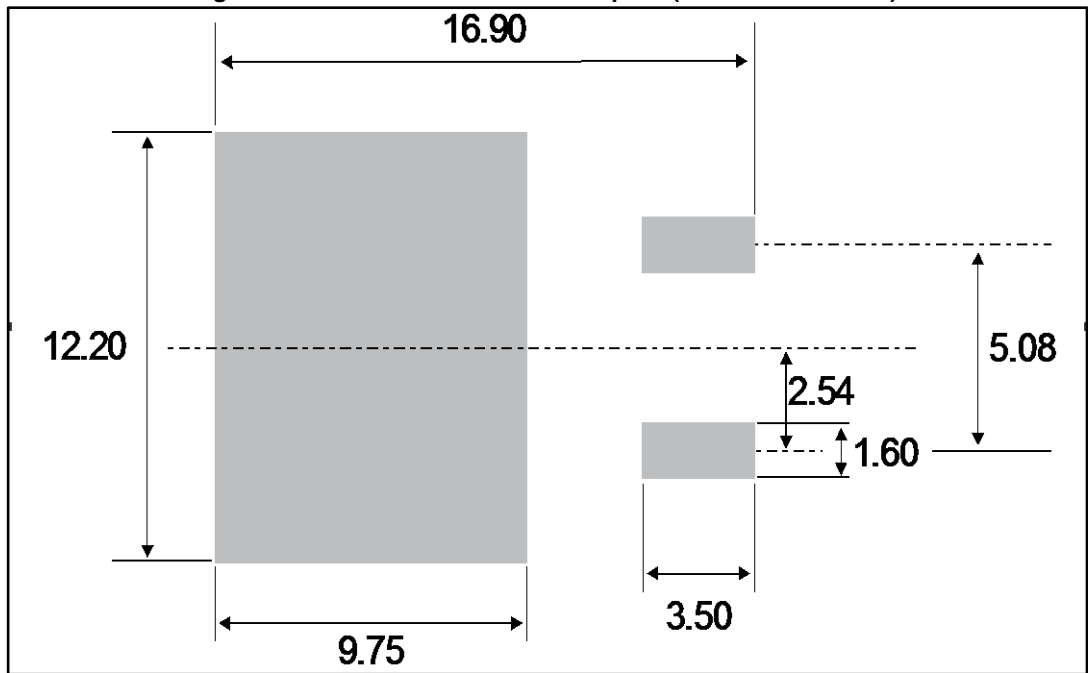

3 Ordering information

Table 8: Ordering information

Order code	Marking	Package	Weight	Base qty.	Delivery mode
STPS20L45CT	STPS20L45CT	TO-220AB	1.95 g	50	Tube
STPS20L45CFP	STPS20L45CFP	TO-220FPAB	1.7 g	50	Tube
STPS20L45CG-TR	STPS20L45CG	D ² PAK	1.38 g	1000	Tape and reel

4 Revision history

Table 9: Document revision history

Date	Revision	Changes
Jul-2003	3C	Last release.
22-Mar-2007	4	Removed ISOWATT and TO-247 packages.
06-Oct-2016	5	Updated cover page. Updated Section 3: "Characteristics" and Section 3.1: "Characteristics (curves)" and Section 5: "Ordering information" and Section 4.4: "D²PAK package information" .

IMPORTANT NOTICE – PLEASE READ CAREFULLY

STMicroelectronics NV and its subsidiaries ("ST") reserve the right to make changes, corrections, enhancements, modifications, and improvements to ST products and/or to this document at any time without notice. Purchasers should obtain the latest relevant information on ST products before placing orders. ST products are sold pursuant to ST's terms and conditions of sale in place at the time of order acknowledgement.

Purchasers are solely responsible for the choice, selection, and use of ST products and ST assumes no liability for application assistance or the design of Purchasers' products.

No license, express or implied, to any intellectual property right is granted by ST herein.

Resale of ST products with provisions different from the information set forth herein shall void any warranty granted by ST for such product.

ST and the ST logo are trademarks of ST. All other product or service names are the property of their respective owners.

Information in this document supersedes and replaces information previously supplied in any prior versions of this document.

© 2016 STMicroelectronics – All rights reserved

单击下面可查看定价，库存，交付和生命周期等信息

[>>STMicro\(意法半导体\)](#)