

30 V, 1 A low drop power Schottky rectifier

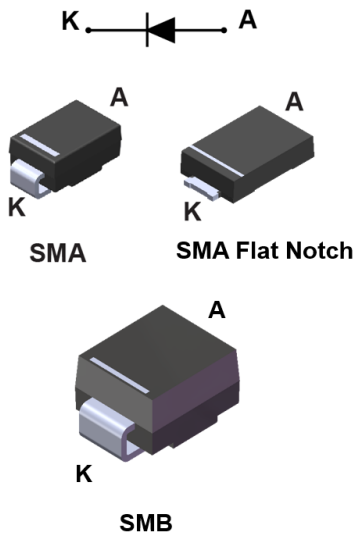

Features

- Very low forward voltage drop for less power dissipation
- Surface mount miniature packages
- Avalanche rated
- ECOPACK2 compliant

Applications

- Cordless appliance
- SSD
- Battery charger
- Telecom power
- DC / DC converter

Description

Schottky rectifiers designed for high frequency miniature switched mode power supplies such as adaptors and on board DC/DC converters.

Packaged in SMA, SMA Flat Notch or SMB, the STPS1L30 is ideal for use in parallel with MOSFETs in synchronous rectification.

| Product status | |
|-----------------|--------|
| STPS1L30 | |
| Product summary | |
| Symbol | Value |
| $I_{F(AV)}$ | 1 A |
| V_{RRM} | 30 V |
| $T_{j(max.)}$ | 150 °C |
| $V_{F(typ.)}$ | 0.26 V |

1 Characteristics

Table 1. Absolute ratings (limiting values at 25 °C, unless otherwise specified)

| Symbol | Parameter | Value | Unit | | |
|--------------|---|--|---------------------------------|----|---|
| V_{RRM} | Repetitive peak reverse voltage | 30 | V | | |
| $I_{F(RMS)}$ | Forward rms current | 10 | A | | |
| $I_{F(AV)}$ | Average forward current, $\delta = 0.5$, square wave | SMA | $T_L = 135\text{ °C}$ | 1 | A |
| | | SMA Flat Notch | $T_L = 140\text{ °C}$ | | |
| | | SMB | $T_L = 140\text{ °C}$ | | |
| I_{FSM} | Surge non repetitive forward current | SMA | $t_p = 10\text{ ms sinusoidal}$ | 75 | A |
| | | SMA Flat Notch | | 90 | |
| | | SMB | | 75 | |
| P_{ARM} | Repetitive peak avalanche power | $t_p = 10\text{ }\mu\text{s}, T_j = 125\text{ °C}$ | 110 | W | |
| T_{stg} | Storage temperature range | -65 to +150 | °C | | |
| T_j | Maximum operating junction temperature ⁽¹⁾ | +150 | °C | | |

1. $(dP_{tot}/dT_j) < (1/R_{th(j-a)})$ condition to avoid thermal runaway for a diode on its own heatsink.

Table 2. Thermal resistance parameter

| Symbol | Parameter | Max. value | Unit | |
|---------------|------------------|----------------|------|------|
| $R_{th(j-l)}$ | Junction to lead | SMA | 30 | °C/W |
| | | SMA Flat Notch | 20 | |
| | | SMB | 25 | |

For more information, please refer to the following application note :

- AN5088 : Rectifiers thermal management, handling and mounting recommendations

Table 3. Static electrical characteristics

| Symbol | Parameter | Test conditions | Min. | Typ. | Max. | Unit |
|-------------|-------------------------|-----------------------|------|-------|-------|---------------|
| $I_R^{(1)}$ | Reverse leakage current | $T_j = 25\text{ °C}$ | - | | 200 | μA |
| | | $T_j = 100\text{ °C}$ | - | 6 | 15 | mA |
| $V_F^{(1)}$ | Forward voltage drop | $T_j = 25\text{ °C}$ | - | | 0.395 | V |
| | | $T_j = 125\text{ °C}$ | - | 0.260 | 0.300 | |
| | | $T_j = 25\text{ °C}$ | - | | 0.445 | |
| | | $T_j = 125\text{ °C}$ | - | 0.325 | 0.375 | |

1. Pulse test: $t_p = 380\text{ }\mu\text{s}$, $\delta < 2\%$

To evaluate the conduction losses, use the following equation:

$$P = 0.225 \times I_{F(AV)} + 0.075 \times I_{F(RMS)}^2$$

For more information, please refer to the following application notes related to the power losses :

- AN604: Calculation of conduction losses in a power rectifier
- AN4021: Calculation of reverse losses on a power diode

1.1 Characteristics (curves)

Figure 1. Average forward power dissipation versus average forward current

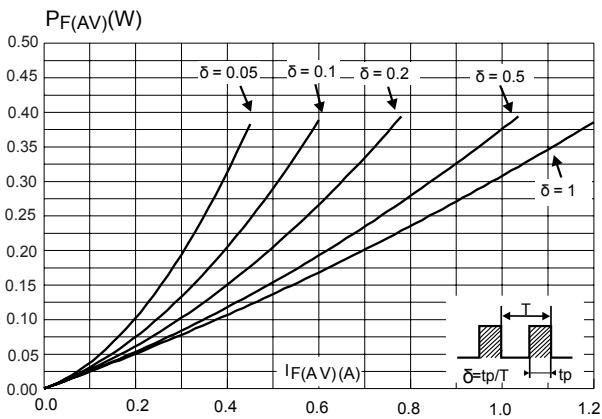

Figure 2. Average forward current versus ambient temperature ($\delta = 0.5$)

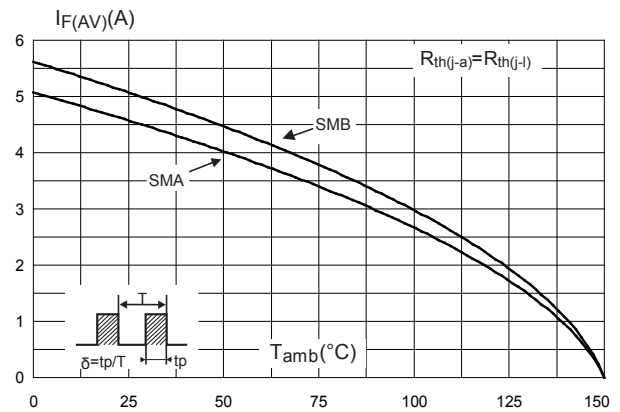

Figure 3. Normalized avalanche power derating versus junction temperature ($T_j = 125\text{ °C}$)

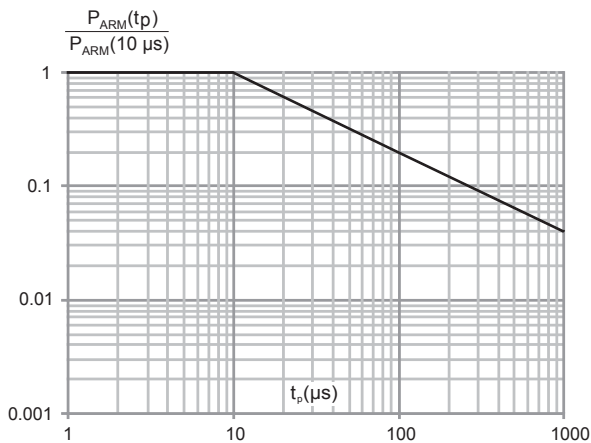

Figure 4. Relative variation of thermal impedance junction to ambient versus pulse duration (SMB)

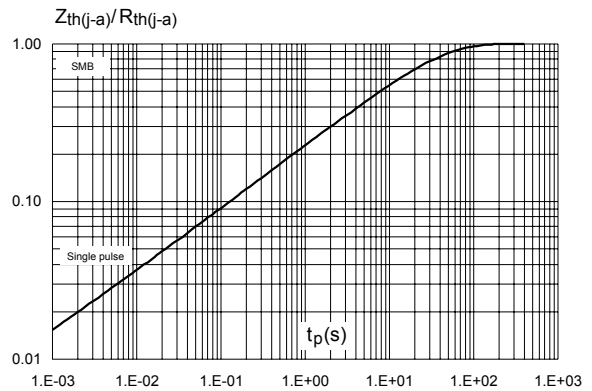

Figure 5. Relative variation of thermal impedance junction to ambient versus pulse duration (SMA)

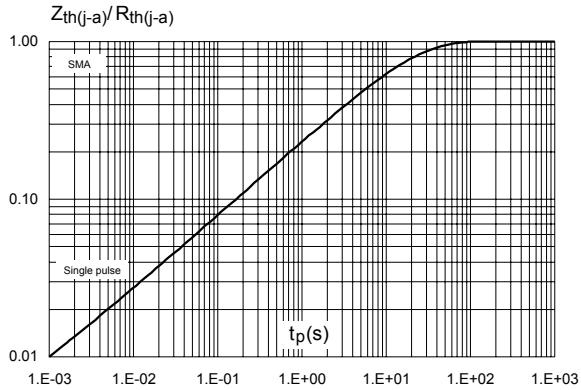

Figure 6. Reverse leakage current versus reverse voltage applied (typical values)

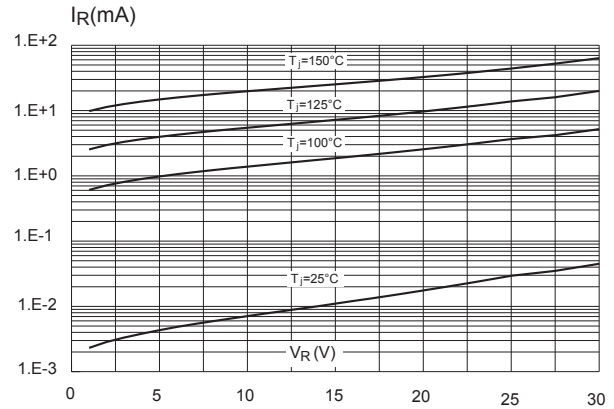

Figure 7. Junction capacitance versus reverse voltage applied (typical values)

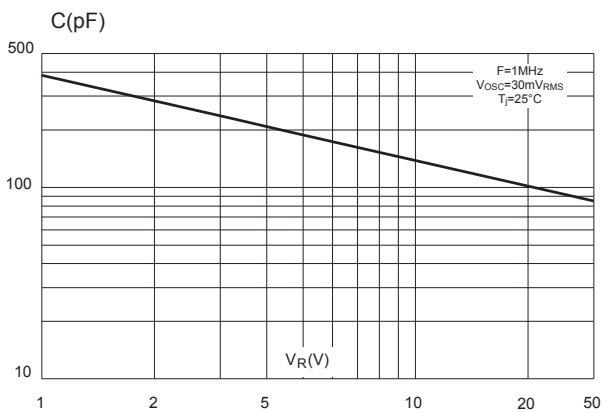

Figure 8. Forward voltage drop versus forward current (typical values, high level)

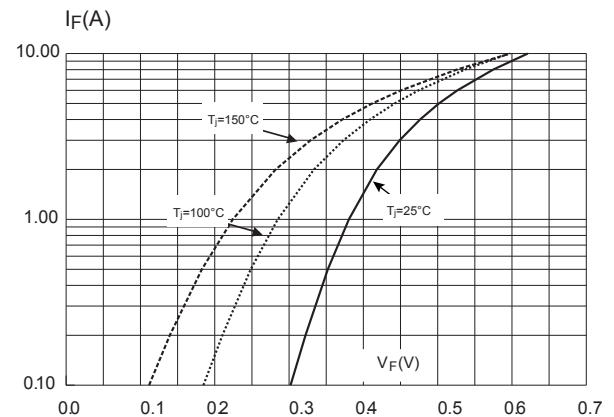

Figure 9. Forward voltage drop versus forward current (maximum values, low level)

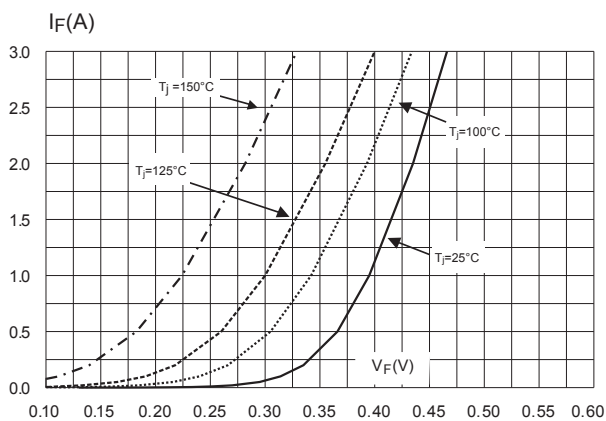

Figure 10. Thermal resistance junction to ambient versus copper surface under each lead (SMB)

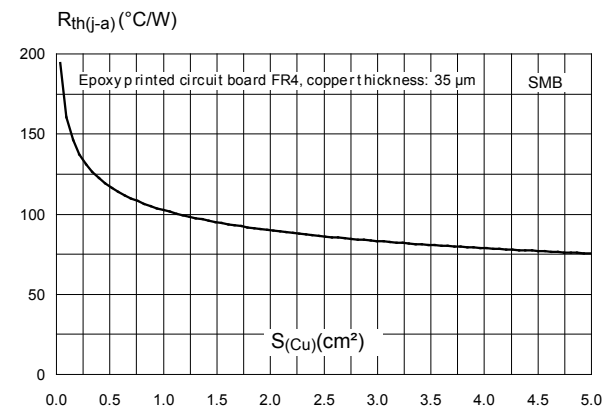

Figure 11. Thermal resistance junction to ambient versus copper surface under each lead (SMA)

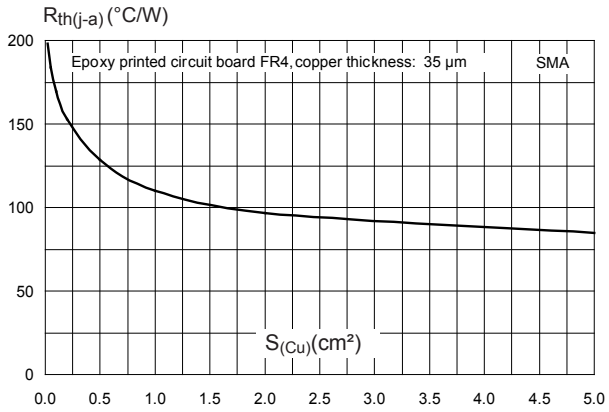
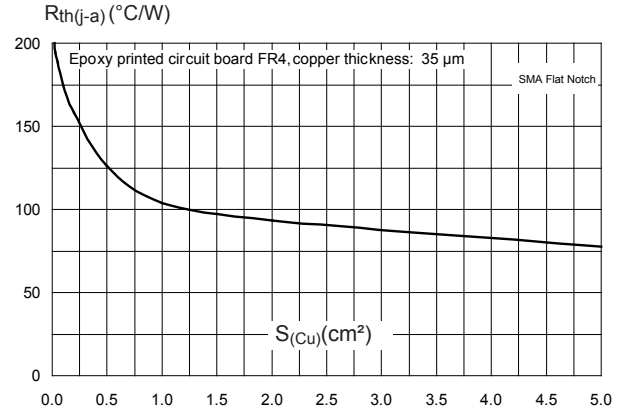

Figure 12. Thermal resistance junction to ambient versus copper surface under each lead (SMA Flat Notch)



2 Package information

In order to meet environmental requirements, ST offers these devices in different grades of **ECOPACK** packages, depending on their level of environmental compliance. ECOPACK specifications, grade definitions and product status are available at: www.st.com. ECOPACK is an ST trademark.

2.1 SMA package information

- Epoxy meets UL94, V0
- Cooling method : by conduction (C)

Figure 13. SMA package outline

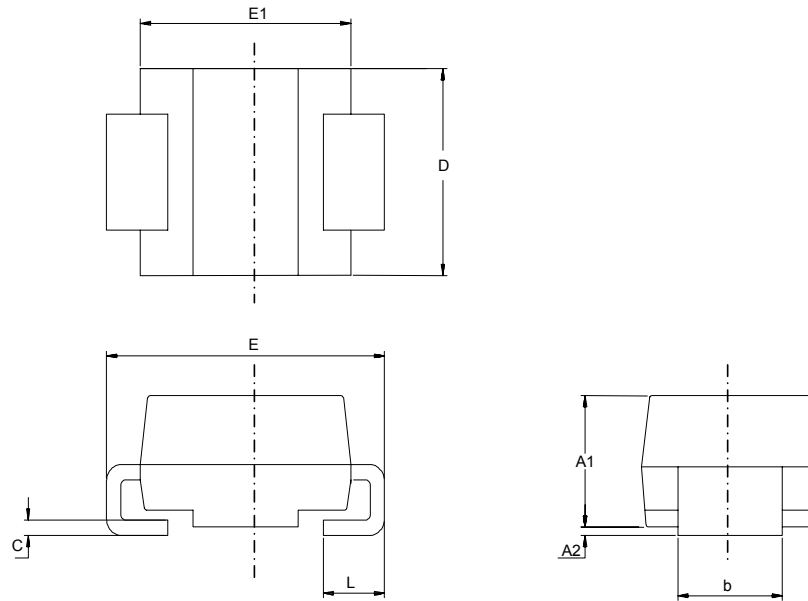
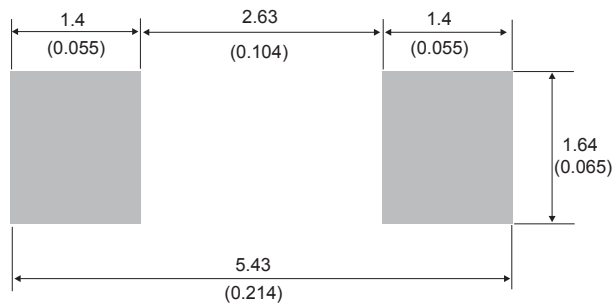

Table 4. SMA package mechanical data

| Ref. | Dimensions | | | |
|------|-------------|------|-----------------------------|-------|
| | Millimeters | | Inches (for reference only) | |
| | Min. | Max. | Min. | Max. |
| A1 | 1.90 | 2.45 | 0.074 | 0.097 |
| A2 | 0.05 | 0.20 | 0.001 | 0.008 |
| b | 1.25 | 1.65 | 0.049 | 0.065 |
| c | 0.15 | 0.40 | 0.005 | 0.016 |
| D | 2.25 | 2.90 | 0.088 | 0.115 |
| E | 4.80 | 5.35 | 0.188 | 0.211 |
| E1 | 3.95 | 4.60 | 0.155 | 0.182 |
| L | 0.75 | 1.50 | 0.029 | 0.060 |

Figure 14. SMA recommended footprint in mm (inches)



2.2 SMA Flat Notch package information

- Epoxy meets UL94, V0
- Cooling method: by conduction (C)
- Band indicates cathode

Figure 15. SMA Flat Notch package outline

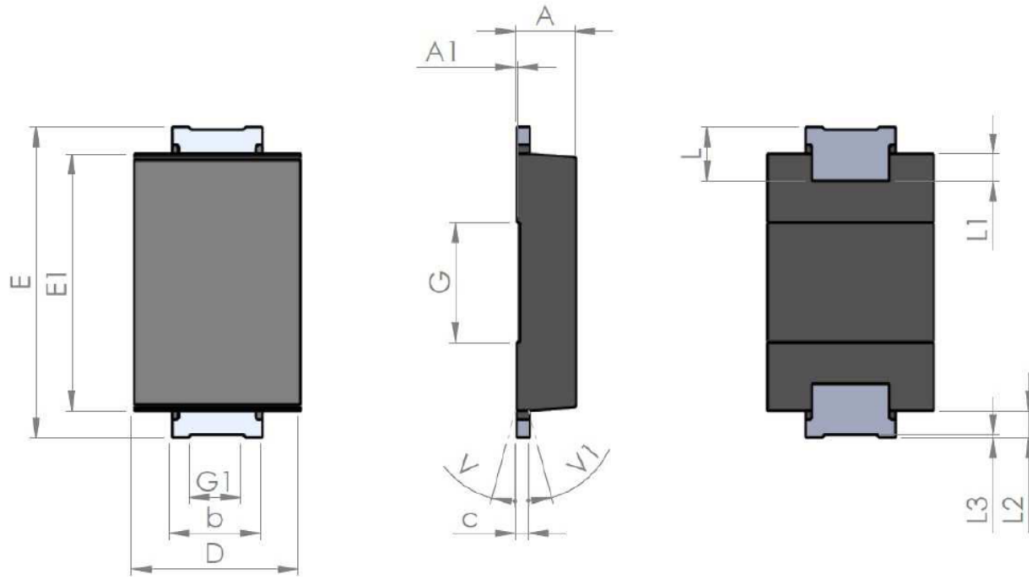
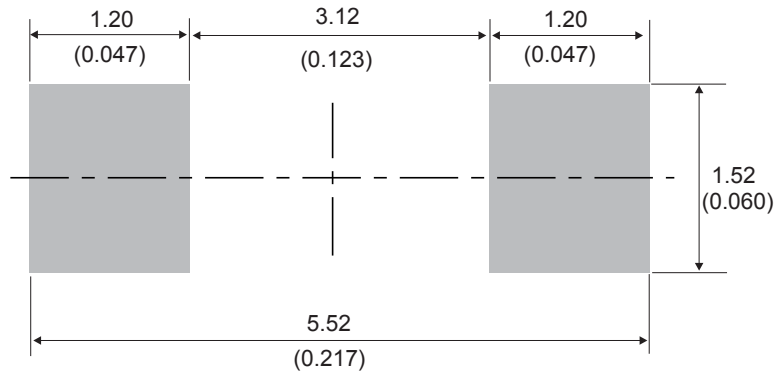

Table 5. SMA Flat Notch package mechanical data

| Ref. | Dimensions | | | | | |
|------|-------------|------|------|-----------------------------|-------|-------|
| | Millimeters | | | Inches (for reference only) | | |
| | Min. | Typ. | Max. | Min. | Typ. | Max. |
| A1 | 0.90 | | 1.10 | 0.035 | | 0.044 |
| A1 | | 0.05 | | | 0.002 | |
| b | 1.25 | | 1.65 | 0.049 | | 0.065 |
| C | 0.15 | | 0.40 | 0.005 | | 0.016 |
| D | 2.25 | | 2.90 | 0.088 | | 0.115 |
| E | 5.00 | | 5.35 | 0.196 | | 0.211 |
| E1 | 3.95 | | 4.60 | 0.155 | | 0.182 |
| G | | 2.00 | | | 0.079 | |
| G1 | | 0.85 | | | 0.033 | |
| L | 0.75 | | 1.20 | 0.029 | | |
| L1 | | 0.45 | | | 0.018 | |
| L2 | | 0.45 | | | 0.018 | |
| L3 | | 0.05 | | | 0.002 | |
| V | | | 8° | | | 8° |
| V1 | | | 8° | | | 8° |

Figure 16. SMA Flat Notch recommended footprint in mm (inches)



2.3 SMB package information

- Epoxy meets UL94, V0
- Lead-free package

Figure 17. SMB package outline

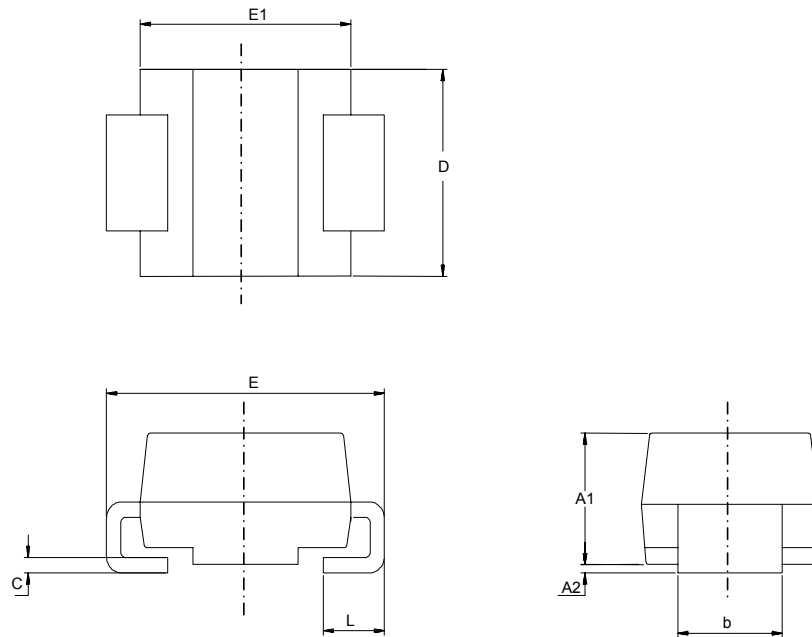
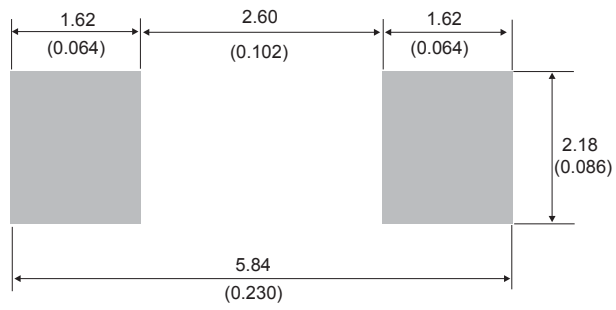

Table 6. SMB package mechanical data

| Ref. | Dimensions | | | |
|------|-------------|------|-----------------------------|-------|
| | Millimeters | | Inches (for reference only) | |
| | Min. | Max. | Min. | Max. |
| A1 | 1.90 | 2.45 | 0.074 | 0.097 |
| A2 | 0.05 | 0.20 | 0.001 | 0.008 |
| b | 1.95 | 2.20 | 0.076 | 0.087 |
| c | 0.15 | 0.40 | 0.005 | 0.016 |
| D | 3.30 | 3.95 | 0.129 | 0.156 |
| E | 5.10 | 5.60 | 0.200 | 0.221 |
| E1 | 4.05 | 4.60 | 0.159 | 0.182 |
| L | 0.75 | 1.50 | 0.029 | 0.060 |

Figure 18. SMB recommended footprint



3 Ordering Information

Table 7. Ordering information

| Order code | Marking | Package | Weight | Base qty. | Delivery mode |
|-------------|---------|----------------|---------|-----------|---------------|
| STPS1L30A | GB3 | SMA | 0.068 g | 5000 | Tape and reel |
| STPS1L30AFN | A13 | SMA Flat Notch | 0.039 g | 10 000 | Tape and reel |
| STPS1L30U | G23 | SMB | 0.107 g | 2500 | Tape and reel |

Revision history

Table 8. Document revision history

| Date | Version | Changes |
|-------------|---------|---|
| Jul-2003 | 5A | Last update. |
| Aug-2004 | 6 | SMA package dimensions update. Reference A1 max changed from 2.70 mm (0.106 inc.) to 2.03 mm (0.080 inc). |
| 17-Sep-2018 | 7 | Updated Table 1. Absolute ratings (limiting values at 25 °C, unless otherwise specified) and Figure 3. Normalized avalanche power derating versus junction temperature (T_j = 125 °C) . |
| 26-Sep-2019 | 8 | Added Section 2.2 SMA Flat Notch package information . |

IMPORTANT NOTICE – PLEASE READ CAREFULLY

STMicroelectronics NV and its subsidiaries (“ST”) reserve the right to make changes, corrections, enhancements, modifications, and improvements to ST products and/or to this document at any time without notice. Purchasers should obtain the latest relevant information on ST products before placing orders. ST products are sold pursuant to ST’s terms and conditions of sale in place at the time of order acknowledgement.

Purchasers are solely responsible for the choice, selection, and use of ST products and ST assumes no liability for application assistance or the design of Purchasers’ products.

No license, express or implied, to any intellectual property right is granted by ST herein.

Resale of ST products with provisions different from the information set forth herein shall void any warranty granted by ST for such product.

ST and the ST logo are trademarks of ST. For additional information about ST trademarks, please refer to www.st.com/trademarks. All other product or service names are the property of their respective owners.

Information in this document supersedes and replaces information previously supplied in any prior versions of this document.

© 2019 STMicroelectronics – All rights reserved

单击下面可查看定价，库存，交付和生命周期等信息

[>>STMicro\(意法半导体\)](#)