

Dual and quad, rail-to-rail input/output, 60 μ A, 880 kHz operational amplifiers

Datasheet - production data



Related products

- See the TSV52x series for higher merit factor (1.15 MHz for 45 μ A)
- See the TSV61x (120 kHz for 9 μ A) or TSV62x (420 kHz for 29 μ A) for more power savings

Applications

- Battery-powered applications
- Portable devices
- Signal conditioning
- Active filtering
- Medical instrumentation

Description

The TSV63x and TSV63xA series of dual and quad operational amplifiers offers low voltage operation and rail-to-rail input and output.

This family features an excellent speed/power consumption ratio, offering an 880 kHz gain-bandwidth product while consuming only 60 μ A at 5 V supply voltage. The devices also feature an ultralow input bias current and TSV633 and TSV635 have a shutdown mode.

These features make the TSV63x and TSV63xA family ideal for sensor interfaces, battery-supplied and portable applications, and active filtering.

Features

- Rail-to-rail input and output
- Low power consumption: 60 μ A typ at 5 V
- Low supply voltage: 1.5 V - 5.5 V
- Gain bandwidth product: 880 kHz typ
- Unity gain stable on 100 pF capacitor
- Low power shutdown mode: 5 nA typ
- Low offset voltage: 800 μ V max (A version)
- Low input bias current: 1 pA typ
- EMI hardened op amps
- Automotive qualification

Table 1: Device summary

Reference	Dual version		Quad version	
	Without standby	With standby	Without standby	With standby
TSV63x	TSV632	TSV633	TSV634	TSV635
TSV63xA	TSV632A	TSV633A	TSV634A	TSV635A

Contents

1 Package pin connections..... 3

2 Absolute maximum ratings and operating conditions 4

3 Electrical characteristics 6

4 Application information 14

 4.1 Operating voltages 14

 4.2 Rail-to-rail input 14

 4.3 Rail-to-rail output..... 14

 4.4 Shutdown function (TSV633, TSV635) 15

 4.5 Optimization of DC and AC parameters 16

 4.6 Driving resistive and capacitive loads 16

 4.7 PCB layouts 16

 4.8 Macromodel 17

5 Package information 18

 5.1 DFN8 2 x 2 (NB) package information 19

 5.2 SOT23-8 package information 21

 5.3 MiniSO8 package information 22

 5.4 MiniSO10 package information 23

 5.5 SO8 package information..... 24

 5.6 QFN16 3x3 package information..... 25

 5.7 TSSOP14 package information..... 27

 5.8 TSSOP16 package information..... 28

6 Ordering information..... 29

7 Revision history 30



1 Package pin connections

Figure 1: Pin connections for each package (top view)

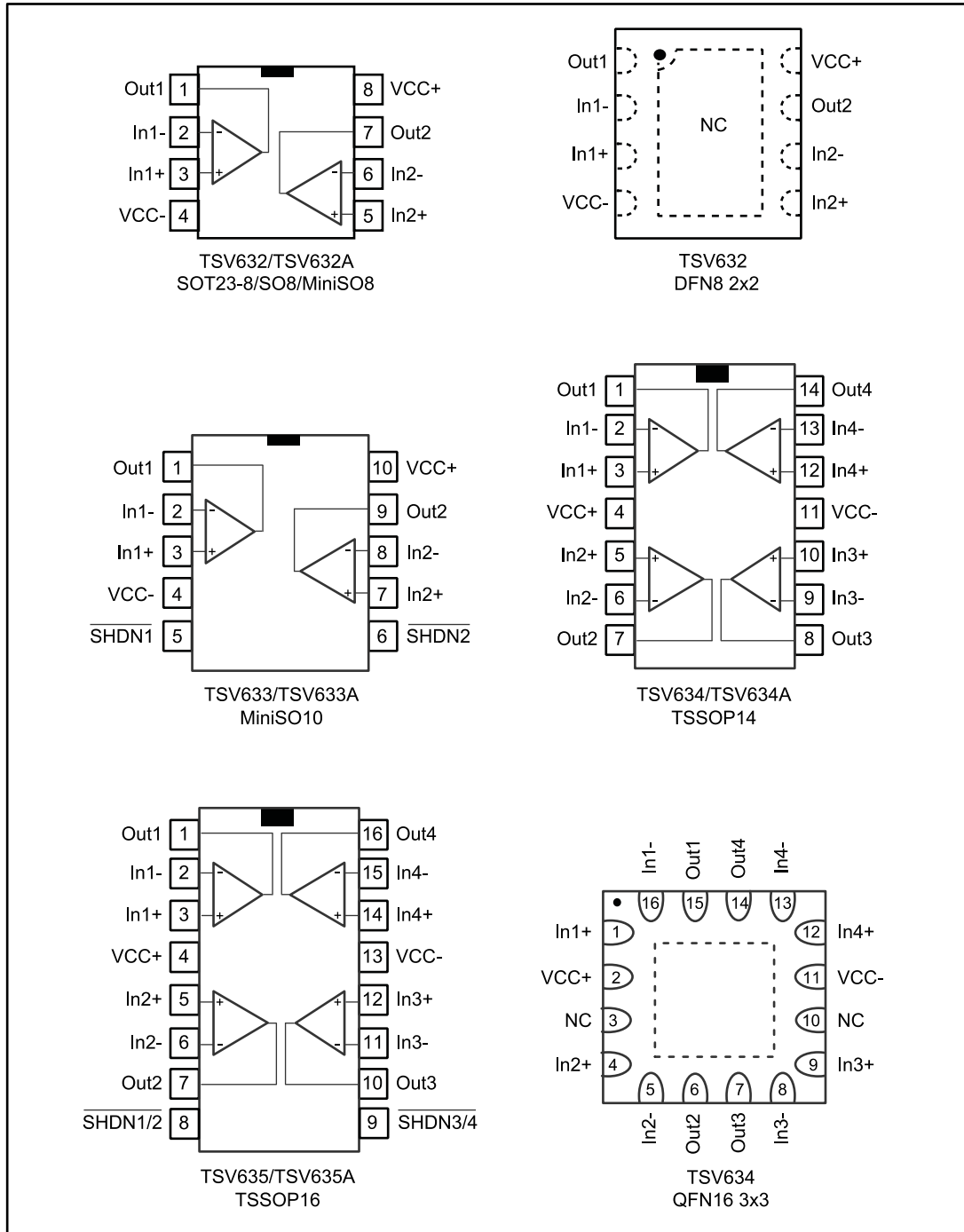

- The exposed pads of the DFN8 2x2 and the QFN16 3x3 can be connected to V_{CC-} or left floating.

2 Absolute maximum ratings and operating conditions

Table 2: Absolute maximum ratings (AMR)

Symbol	Parameter	Value	Unit	
V _{CC}	Supply voltage ⁽¹⁾	6	V	
V _{id}	Differential input voltage ⁽²⁾	±V _{CC}		
V _{in}	Input voltage ⁽³⁾	(V _{CC-}) - 0.2 to (V _{CC+}) + 0.2		
I _{in}	Input current ⁽⁴⁾	10	mA	
$\overline{\text{SHDN}}$ SHDN	Shutdown voltage ⁽³⁾	(V _{CC-}) - 0.2 to (V _{CC+}) + 0.2	V	
T _{stg}	Storage temperature	-65 to 150	°C	
R _{thja}	Thermal resistance junction to ambient ^(5/6)	DFN8 2x2	57	°C/W
		SOT23-8	105	
		MiniSO8	190	
		MiniSO10	113	
		SO8	125	
		QFN16 3x3	39	
		TSSOP14	100	
TSSOP16	95			
T _j	Maximum junction temperature	150	°C	
ESD	HBM: human body model ⁽⁷⁾	4000	V	
	MM: machine model ⁽⁸⁾	300		
	CDM: charged device model ⁽⁹⁾	1500		
	Latch-up immunity	200	mA	

Notes:

- ⁽¹⁾All voltage values, except the differential voltage are with respect to the network ground terminal.
- ⁽²⁾Differential voltages are the non-inverting input terminal with respect to the inverting input terminal.
- ⁽³⁾V_{CC} - V_{IN} must not exceed 6 V, V_{IN} must not exceed 6 V.
- ⁽⁴⁾Input current must be limited by a resistor in series with the inputs
- ⁽⁵⁾R_{th} are typical values
- ⁽⁶⁾Short-circuits can cause excessive heating and destructive dissipation
- ⁽⁷⁾Human body model: 100 pF discharged through a 1.5 kΩ resistor between two pins of the device, done for all couples of pin combinations with other pins floating.
- ⁽⁸⁾Machine model: a 200 pF cap is charged to the specified voltage, then discharged directly between two pins of the device with no external series resistor (internal resistor < 5 Ω), done for all couples of pin combinations with other pins floating
- ⁽⁹⁾Charged device model: all pins plus package are charged together to the specified voltage and then discharged directly to the ground.



Table 3: Operating conditions

Symbol	Parameter	Value	Unit
V_{CC}	Supply voltage	1.5 to 5.5	V
V_{ICM}	Common-mode input voltage range	$(V_{CC-}) - 0.1$ to $(V_{CC+}) + 0.1$	
T_{oper}	Operating free-air temperature range	-40 to 125	°C

3 Electrical characteristics

Table 4: Electrical characteristics at $V_{CC+} = 1.8\text{ V}$ with $V_{CC-} = 0\text{ V}$, $V_{icm} = V_{CC}/2$, $T_{amb} = 25^\circ\text{ C}$, and R_L connected to $V_{CC}/2$ (unless otherwise specified)

Symbol	Parameter	Conditions	Min.	Typ.	Max.	Unit
DC performance						
V_{io}	Offset voltage	TSV63x			3	mV
		TSV63xA			0.8	
		TSV633AIST (MiniSO10)			1	
		$T_{min} < T_{op} < T_{max}$ - TSV63x			4.5	
		$T_{min} < T_{op} < T_{max}$ - TSV63xA			2	
		$T_{min} < T_{op} < T_{max}$ - TSV633AIST			2.2	
$\Delta V_{io}/\Delta T$	Input offset voltage drift			2		$\mu\text{V}/^\circ\text{C}$
I_{io}	Input offset current	$(V_{out} = V_{CC}/2)$		1	$10^{(1)}$	pA
		$T_{min} < T_{op} < T_{max}$		1	100	
I_{ib}	Input bias current	$(V_{out} = V_{CC}/2)$		1	$10^{(1)}$	pA
		$T_{min} < T_{op} < T_{max}$		1	100	
CMR	Common mode rejection ratio $20 \log (\Delta V_{ic}/\Delta V_{io})$	$0\text{ V to }1.8\text{ V}, V_{out} = 0.9\text{ V}$	53	74		dB
		$T_{min} < T_{op} < T_{max}$	51			
A_{vd}	Large signal voltage gain	$R_L = 10\text{ k}\Omega, V_{out} = 0.5\text{ V to }1.3\text{ V}$	85	95		dB
		$T_{min} < T_{op} < T_{max}$	80			
V_{OH}	High level output voltage, $(V_{OH} = V_{CC} - V_{out})$	$R_L = 10\text{ k}\Omega$		5	35	mV
		$T_{min} < T_{op} < T_{max}$			50	
V_{OL}	Low level output voltage	$R_L = 10\text{ k}\Omega$		4	35	mV
		$T_{min} < T_{op} < T_{max}$			50	
I_{out}	I_{sink}	$V_o = 1.8\text{ V}$	6	12		mA
		$T_{min} < T_{op} < T_{max}$	4			
	I_{source}	$V_o = 0\text{ V}$	6	10		
		$T_{min} < T_{op} < T_{max}$	4			
I_{CC}	Supply current (per channel)	No load, $V_{out} = V_{CC}/2$	40	50	60	μA
		$T_{min} < T_{op} < T_{max}$			62	
AC performance						
GBP	Gain bandwidth product	$R_L = 2\text{ k}\Omega, C_L = 100\text{ pF}, f = 100\text{ kHz}$	700	790		kHz
ϕ_m	Phase margin	$R_L = 2\text{ k}\Omega, C_L = 100\text{ pF}$		45		Degrees
G_m	Gain margin	$R_L = 2\text{ k}\Omega, C_L = 100\text{ pF}$		13		dB
SR	Slew rate	$R_L = 2\text{ k}\Omega, C_L = 100\text{ pF}, A_v = 1$	0.2	0.27		$\text{V}/\mu\text{s}$
e_n	Equivalent input noise voltage	$f = 1\text{ kHz}$		60		$\text{nV}/\sqrt{\text{Hz}}$
		$f = 10\text{ kHz}$		33		

Notes:⁽¹⁾Guaranteed by design

Table 5: Shutdown characteristics VCC = 1.8 V

Symbol	Parameter	Conditions	Min.	Typ.	Max.	Unit
DC performance						
I _{CC}	Supply current in shutdown mode (all channels)	$\overline{\text{SHDN}} = V_{CC-}$		2.5	50	nA
		T _{min} < T _{op} < 85° C			200	
		T _{min} < T _{op} < 125° C			1.5	μA
t _{on}	Amplifier turn-on time	R _L = 2 kΩ, V _{out} = (V _{CC-}) to (V _{CC-}) + 0.2 V		200		ns
t _{off}	Amplifier turn-off time	R _L = 2 kΩ, V _{out} = (V _{CC+}) - 0.5 V to (V _{CC+}) - 0.7 V		20		
V _{IH}	$\overline{\text{SHDN}}$ logic high		1.35			V
V _{IL}	$\overline{\text{SHDN}}$ logic low				0.6	
I _{IH}	$\overline{\text{SHDN}}$ current high	$\overline{\text{SHDN}} = V_{CC+}$		10		pA
I _{IL}	$\overline{\text{SHDN}}$ current low	$\overline{\text{SHDN}} = V_{CC-}$		10		
I _{OLeak}	Output leakage in shutdown mode	$\overline{\text{SHDN}} = V_{CC-}$		50		
		T _{min} < T _{op} < 125° C		1		nA

Table 6: VCC+ = 3.3 V, VCC- = 0 V, Vicm = VCC/2, Tamb = 25° C, RL connected to VCC/2 (unless otherwise specified)

Symbol	Parameter	Conditions	Min.	Typ.	Max.	Unit
DC performance						
V _{io}	Offset voltage	TSV63x			3	mV
		TSV63xA			0.8	
		TSV633AIST (MiniSO10)			1	
		T _{min} < T _{op} < T _{max} - TSV63x			4.5	
		T _{min} < T _{op} < T _{max} - TSV63xA			2	
		T _{min} < T _{op} < T _{max} - TSV633AIST			2.2	
ΔV _{io} /ΔT	Input offset voltage drift			2		μV/°C
I _{io}	Input offset current	V _{out} = V _{CC} /2		1	10 ⁽¹⁾	pA
		T _{min} < T _{op} < T _{max}		1	100	
I _{ib}	Input bias current	V _{out} = V _{CC} /2		1	10 ⁽¹⁾	pA
		T _{min} < T _{op} < T _{max}		1	100	
CMR	Common mode rejection ratio 20 log (ΔV _{ic} /ΔV _{io})	0 V to 3.3 V, V _{out} = 1.65 V	57	79		dB
		T _{min} < T _{op} < T _{max}	53			
A _{vd}	Large signal voltage gain	R _L = 10 kΩ, V _{out} = 0.5 V to 2.8 V	88	98		dB
		T _{min} < T _{op} < T _{max}	83			
V _{OH}	High level output voltage, (V _{OH} = V _{CC} - V _{out})	R _L = 10 kΩ		5	35	mV
		T _{min} < T _{op} < T _{max}			50	
V _{OL}	Low level output voltage	R _L = 10 kΩ		4	35	mV
		T _{min} < T _{op} < T _{max}			50	
I _{out}	I _{sink}	V _o = 3.3 V	23	45		mA
		T _{min} < T _{op} < T _{max}	20			
	I _{source}	V _o = 0 V	23	38		
		T _{min} < T _{op} < T _{max}	20			
I _{CC}	Supply current, (per channel)	No load, V _{out} = 1.75 V	43	55	64	μA
		T _{min} < T _{op} < T _{max}			66	
AC performance						
GBP	Gain bandwidth product	R _L = 2 kΩ, C _L = 100 pF, f = 100 kHz	710	860		kHz
φ _m	Phase margin	R _L = 2 kΩ, C _L = 100 pF		46		Degrees
G _m	Gain margin	R _L = 2 kΩ, C _L = 100 pF		13		dB
SR	Slew rate	R _L = 2 kΩ, C _L = 100 pF, A _V = 1	0.22	0.29		V/μs

Notes:

⁽¹⁾Guaranteed by design



Table 7: Electrical characteristics at VCC+ = 5 V with VCC- = 0 V, Vicm = VCC/2, Tamb = 25° C, and RL connected to VCC/2 (unless otherwise specified)

Symbol	Parameter	Conditions	Min.	Typ.	Max.	Unit
DC performance						
V _{io}	Offset voltages	TSV63x			3	mV
		TSV63xA			0.8	
		TSV633AIST (MiniSO10)			1	
		T _{min} < T _{op} < T _{max} - TSV63x			4.5	
		T _{min} < T _{op} < T _{max} - TSV63xA			2	
		T _{min} < T _{op} < T _{max} - TSV633AIST			2.2	
ΔV _{io} /ΔT	Input offset voltage drift			2		μV/°C
I _{io}	Input offset current	(V _{out} = V _{CC} /2)		1	10 ⁽¹⁾	pA
		T _{min} < T _{op} < T _{max}		1	100	
I _{ib}	Input bias current	(V _{out} = V _{CC} /2)		1	10 ⁽¹⁾	pA
		T _{min} < T _{op} < T _{max}		1	100	
CMR	Common mode rejection ratio 20 log (ΔV _{ic} /ΔV _{io})	0 V to 5 V, V _{out} = 2.5 V	60	80		dB
		T _{min} < T _{op} < T _{max}	55			
SVR	Supply voltage rejection ratio 20 log (ΔV _{CC} /ΔV _{io})	V _{CC} = 1.8 to 5 V	75	102		dB
		T _{min} < T _{op} < T _{max}	73			
A _{vd}	Large signal voltage gain	R _L = 10 kΩ, V _{out} = 0.5 V to 4.5 V	89	98		dB
		T _{min} < T _{op} < T _{max}	84			
EMIRR	EMI rejection ratio, EMIRR = -20 log (V _{RFpeak} /ΔV _{io})	V _{RF} = 100 mV _{rms} , f = 400 MHz		61		dB
		V _{RF} = 100 mV _{rms} , f = 900 MHz		85		
		V _{RF} = 100 mV _{rms} , f = 1800 MHz		92		
		V _{RF} = 100 mV _{rms} , f = 2400 MHz		83		
V _{OH}	High level output voltage, (V _{OH} = V _{CC} - V _{out})	R _L = 10 kΩ		7	35	mV
		T _{min} < T _{op} < T _{max}			50	
V _{OL}	Low level output voltage	R _L = 10 kΩ		6	35	mV
		T _{min} < T _{op} < T _{max}			50	
I _{out}	I _{sink}	V _o = 5 V	40	69		mA
		T _{min} < T _{op} < T _{max}	35			
	I _{source}	V _o = 0 V	40	74		
		T _{min} < T _{op} < T _{max}	35			
I _{CC}	Supply current, (per channel)	No load, V _{out} = V _{CC} /2	50	60	69	μA
		T _{min} < T _{op} < T _{max}			72	
AC performance						
GBP	Gain bandwidth product	R _L = 2 kΩ, C _L = 100 pF, f = 100 kHz	730	880		kHz
F _u	Unity gain frequency	R _L = 2 kΩ, C _L = 100 pF		830		
φ _m	Phase margin	R _L = 2 kΩ, C _L = 100 pF		48		Degrees

Electrical characteristics

TSV632, TSV632A, TSV633, TSV633A, TSV634, TSV634A, TSV635, TSV635A

Symbol	Parameter	Conditions	Min.	Typ.	Max.	Unit
G_m	Gain margin	$R_L = 2\text{ k}\Omega, C_L = 100\text{ pF}$		13		dB
SR	Slew rate	$R_L = 2\text{ k}\Omega, C_L = 100\text{ pF}, A_v = 1$	0.25	0.34		V/ μ s
e_n	Equivalent input noise voltage	$f = 1\text{ kHz}$		60		nV/ $\sqrt{\text{Hz}}$
		$f = 10\text{ kHz}$		33		
THD+ e_n	Total harmonic distortion + noise	$V_{CC} = 5\text{V}, f = 1\text{ kHz}, A_v = 1, R_L = 100\text{ k}\Omega, V_{icm} = V_{CC}/2, V_{out} = 2V_{pp}$		0.002		%

Notes:

(1) Guaranteed by design

Table 8: Shutdown characteristics at $V_{CC} = 5\text{ V}$

Symbol	Parameter	Conditions	Min.	Typ.	Max.	Unit
DC performance						
I_{CC}	Supply current in shutdown mode (all channels)	$\overline{\text{SHDN}} = V_{CC-}$		5	50	nA
		$T_{min} < T_{op} < 85^\circ\text{ C}$			200	
		$T_{min} < T_{op} < 125^\circ\text{ C}$				1.5
t_{on}	Amplifier turn-on time	$R_L = 2\text{ k}\Omega, V_{out} = (V_{CC-})$ to $(V_{CC-}) + 0.2\text{ V}$		200		ns
t_{off}	Amplifier turn-off time	$R_L = 2\text{ k}\Omega, V_{out} = (V_{CC+}) - 0.5\text{ V}$ to $(V_{CC+}) - 0.7\text{ V}$		20		
V_{IH}	$\overline{\text{SHDN}}$ logic high		2			V
V_{IL}	$\overline{\text{SHDN}}$ logic low				0.8	
I_{IH}	$\overline{\text{SHDN}}$ current high	$\overline{\text{SHDN}} = V_{CC+}$		10		pA
I_{IL}	$\overline{\text{SHDN}}$ current low	$\overline{\text{SHDN}} = V_{CC-}$		10		
I_{OLeak}	Output leakage in shutdown mode	$\overline{\text{SHDN}} = V_{CC-}$		50		
		$T_{min} < T_{op} < 125^\circ\text{ C}$		1		nA



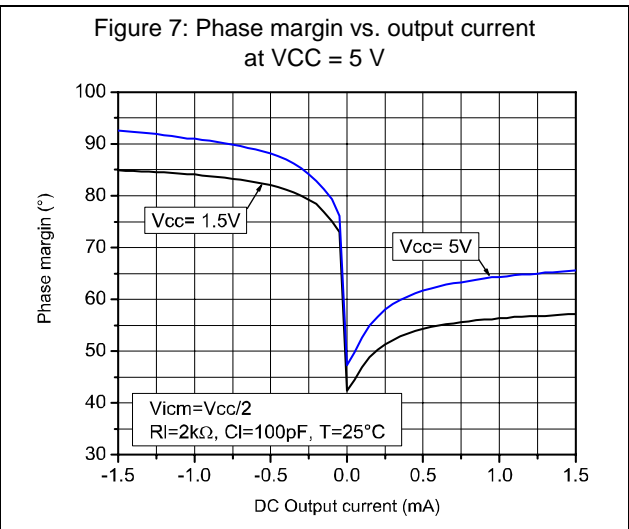
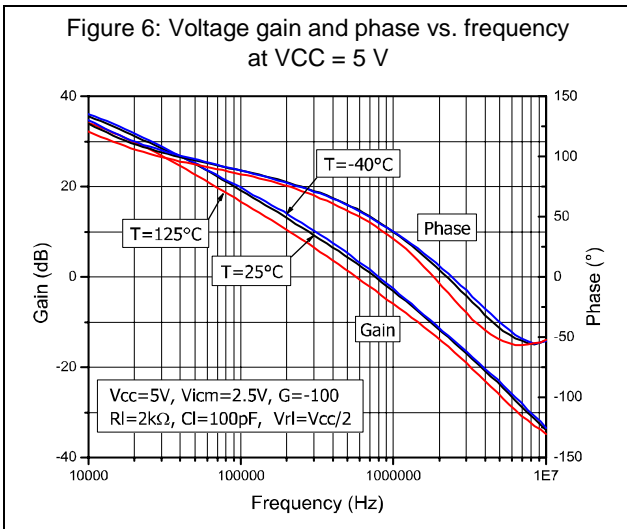
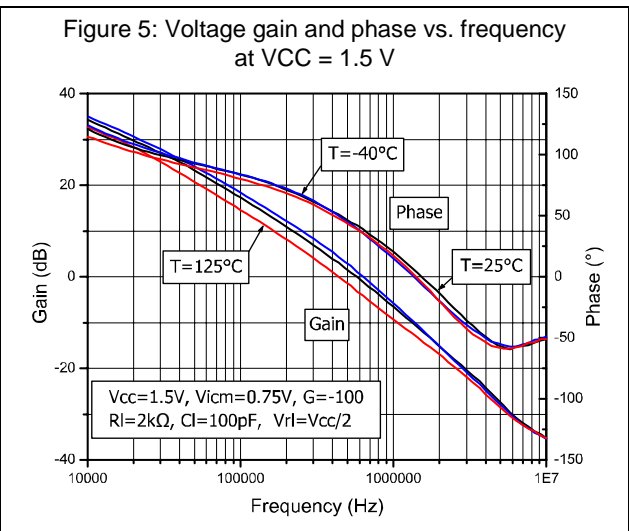
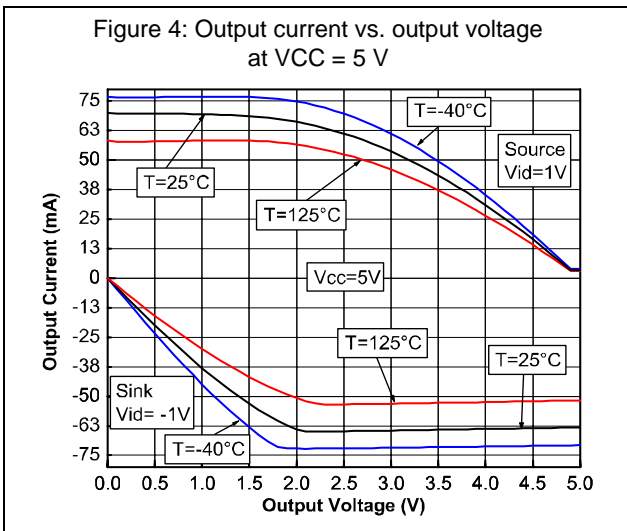
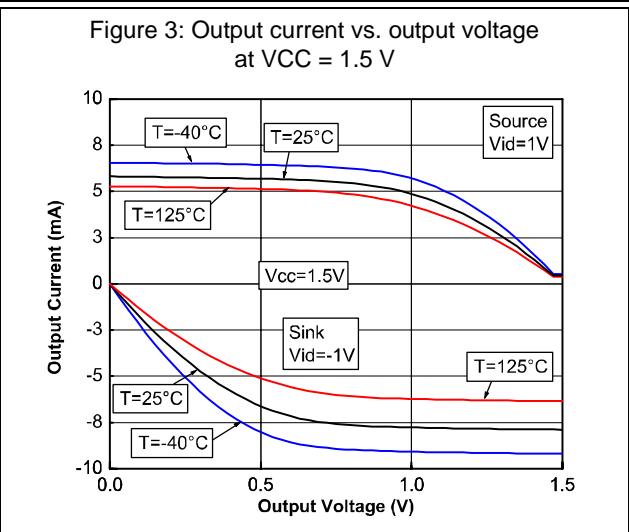
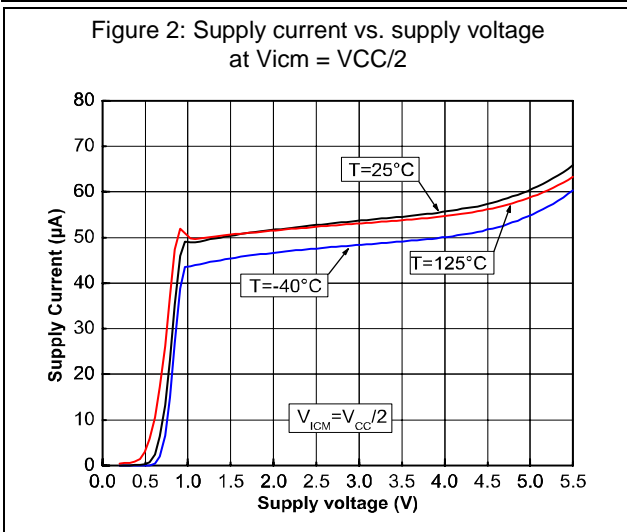

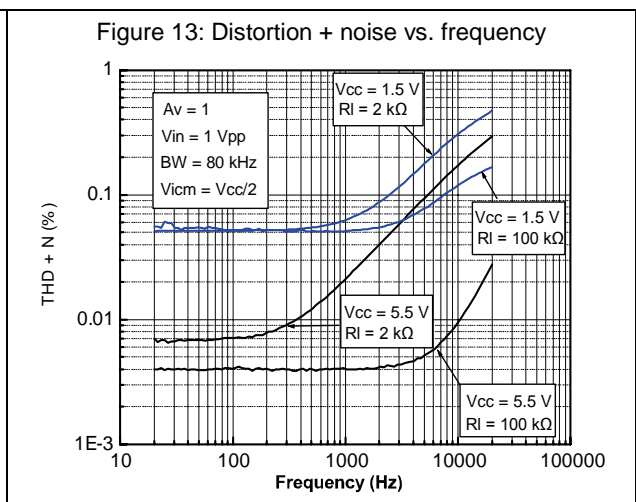
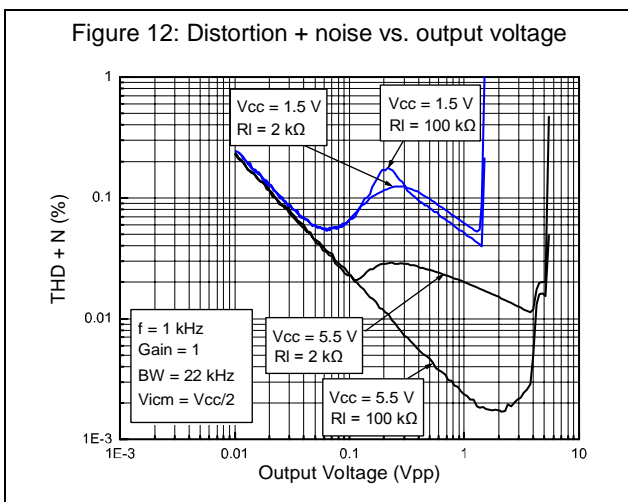
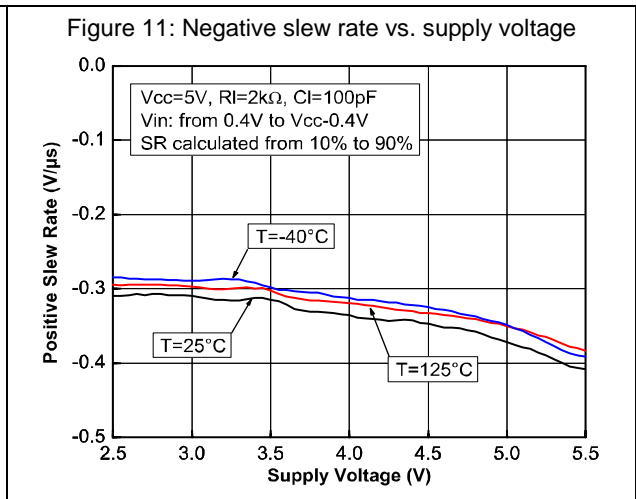
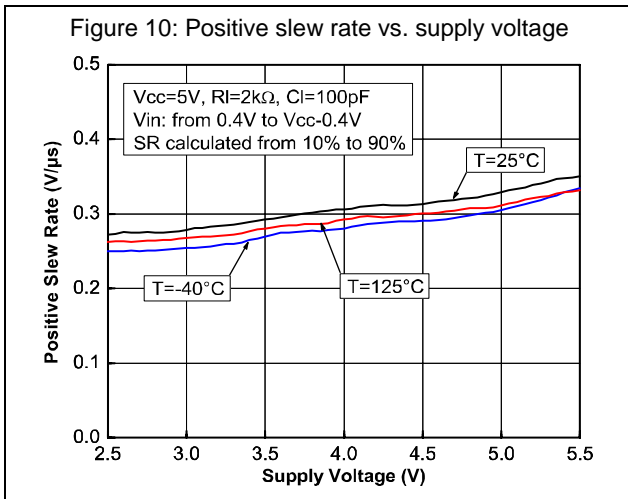
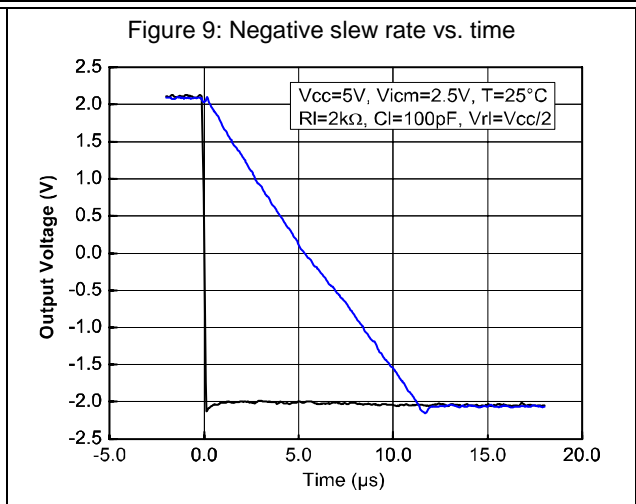
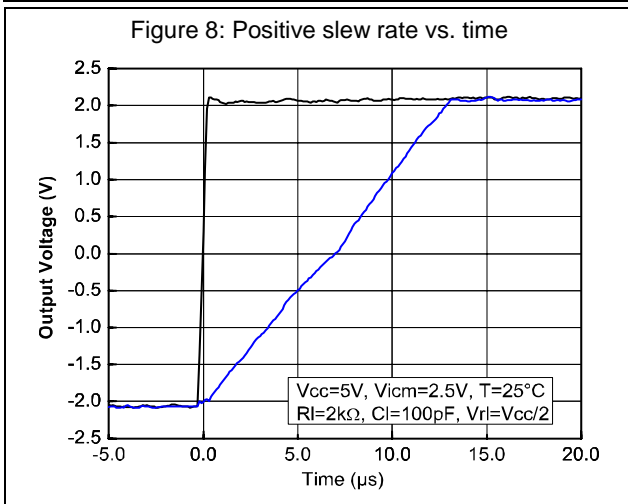



4 Application information

4.1 Operating voltages

The TSV63x and TSV63xA can operate from 1.5 to 5.5 V. Their parameters are fully specified for 1.8 V, 3.3 V, and 5 V power supplies. However, the parameters are very stable in the full V_{CC} range and several characterization curves show the TSV63x and TSV63xA characteristics at 1.5 V. Additionally, the main specifications are guaranteed in extended temperature ranges from $-40\text{ }^{\circ}\text{C}$ to $125\text{ }^{\circ}\text{C}$.

4.2 Rail-to-rail input

The TSV63x and TSV63xA are built with two complementary PMOS and NMOS input differential pairs. The devices have a rail-to-rail input and the input common mode range is extended from $(V_{CC-}) - 0.1\text{ V}$ to $(V_{CC+}) + 0.1\text{ V}$. The transition between the two pairs appears at $(V_{CC+}) - 0.7\text{ V}$. In the transition region, the performance of CMRR, PSRR, V_{io} (Figure 16 and Figure 17), and THD is slightly degraded.

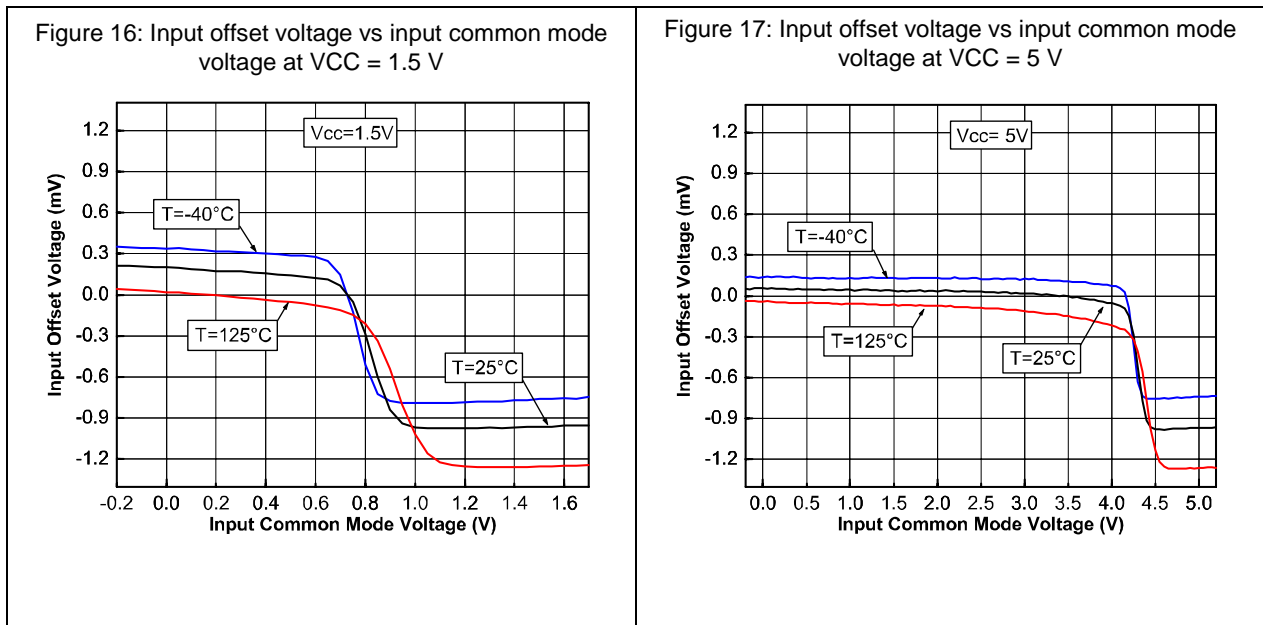

The devices are guaranteed without phase reversal.

4.3 Rail-to-rail output

The operational amplifiers' output levels can go close to the rails: 35 mV maximum above and below the rail when connected to a $10\text{ k}\Omega$ resistive load to $V_{CC}/2$.

4.4 Shutdown function (TSV633, TSV635)

The operational amplifiers are enabled when the $\overline{\text{SHDN}}$ pin is pulled high. To disable the amplifiers, the $\overline{\text{SHDN}}$ must be pulled down to V_{CC-} . When in shutdown mode, the amplifiers' output is in a high impedance state. The $\overline{\text{SHDN}}$ pin must never be left floating, but tied to V_{CC+} or V_{CC-} .

The turn-on and turn-off times are calculated for an output variation of ± 200 mV. *Figure 18* and *Figure 19* show the test configurations. *Figure 20* shows the time it takes the product to come out of shutdown mode and *Figure 21* shows the time it takes the product to enter shutdown mode.



4.5 Optimization of DC and AC parameters

These devices use an innovative approach to reduce the spread of the main DC and AC parameters. An internal adjustment achieves a very narrow spread of the current consumption (60 μA typical, min/max at $\pm 17\%$). Parameters linked to the current consumption value, such as GBP, SR, and A_{vd} , benefit from this narrow dispersion. All parts present a similar speed and the same behavior in terms of stability. In addition, the minimum values of GBP and SR are guaranteed (GBP = 730 kHz minimum and SR = 0.25 V/ μs minimum).

4.6 Driving resistive and capacitive loads

These products are micropower, low-voltage, operational amplifiers optimized to drive rather large resistive loads, above 2 k Ω . For lower resistive loads, the THD level may significantly increase.

In a *follower* configuration, these operational amplifiers can drive capacitive loads up to 100 pF with no oscillations. When driving larger capacitive loads, adding an in-series resistor at the output can improve the stability of the devices (see [Figure 22](#) for recommended in-series resistor values). Once the in-series resistor value has been selected, the stability of the circuit should be tested on the bench and simulated with the simulation model.

Figure 22: In-series resistor vs. capacitive load

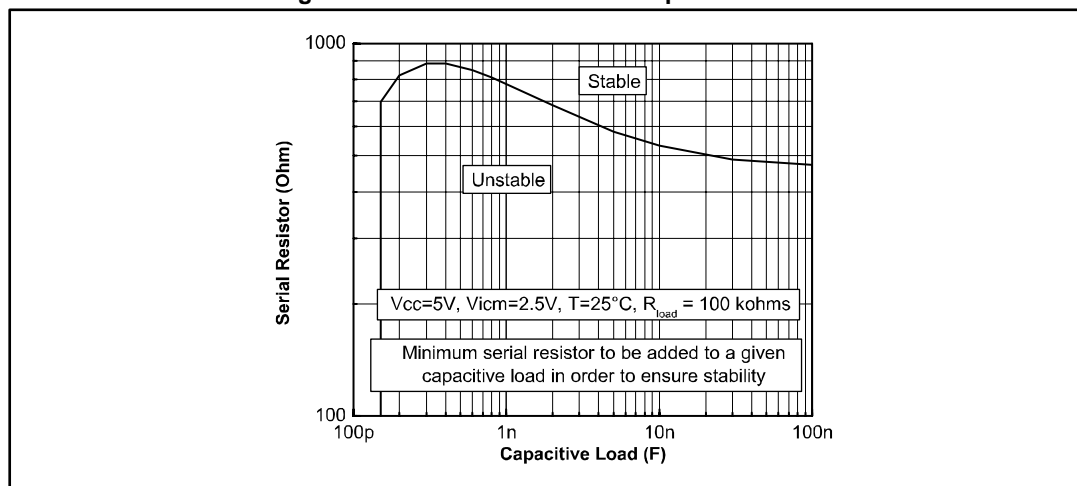

4.7 PCB layouts

For correct operation, it is advised to add 10 nF decoupling capacitors as close as possible to the power supply pins.

4.8 Macromodel

Two accurate macromodels (with or without the shutdown feature) of the TSV63x and TSV63xA are available on STMicroelectronics' web site at www.st.com. These models are a trade-off between accuracy and complexity (that is, time simulation) of the TSV63x and TSV63xA operational amplifiers. They emulate the nominal performances of a typical device within the specified operating conditions mentioned in the datasheet. They also help to validate a design approach and to select the right operational amplifier, *but they do not replace on-board measurements*.

5 Package information

In order to meet environmental requirements, ST offers these devices in different grades of ECOPACK[®] packages, depending on their level of environmental compliance. ECOPACK[®] specifications, grade definitions and product status are available at: www.st.com. ECOPACK[®] is an ST trademark.

5.1 DFN8 2 x 2 (NB) package information

Figure 23: DFN8 2 x 2 mm (NB) package outline



Table 9: DFN8 2 x 2 x 0.6 mm (NB) package mechanical data (pitch 0.5 mm)

Ref.	Dimensions					
	Millimeters			Inches		
	Min.	Typ.	Max.	Min.	Typ.	Max.
A	0.51	0.55	0.60	0.020	0.022	0.024
A1			0.05			0.002
A3		0.15			0.006	
b	0.18	0.25	0.30	0.007	0.010	0.012
D	1.85	2.00	2.15	0.073	0.079	0.085
D2	1.45	1.60	1.70	0.057	0.063	0.067
E	1.85	2.00	2.15	0.073	0.079	0.085
E2	0.75	0.90	1.00	0.030	0.035	0.039
e		0.50			0.020	
L			0.425			0.017
ddd			0.08			0.003

Figure 24: DFN8 2 x 2 mm (NB) recommended footprint



5.2 SOT23-8 package information

Figure 25: SOT23-8 package outline



Table 10: SOT23-8 package mechanical data

Ref.	Dimensions					
	Millimeters			Inches		
	Min.	Typ.	Max.	Min.	Typ.	Max.
A			1.45			0.057
A1			0.15			0.006
A2	0.90		1.30	0.035		0.051
b	0.22		0.38	0.009		0.015
c	0.08		0.22	0.003		0.009
D	2.80		3.00	0.110		0.118
E	2.60		3.00	0.102		0.118
E1	1.50		1.75	0.059		0.069
e		0.65			0.026	
e1		1.95			0.077	
L	0.30		0.60	0.012		0.024
<	0°		8°	0°		8°

5.3 MiniSO8 package information

Figure 26: MiniSO8 package outline

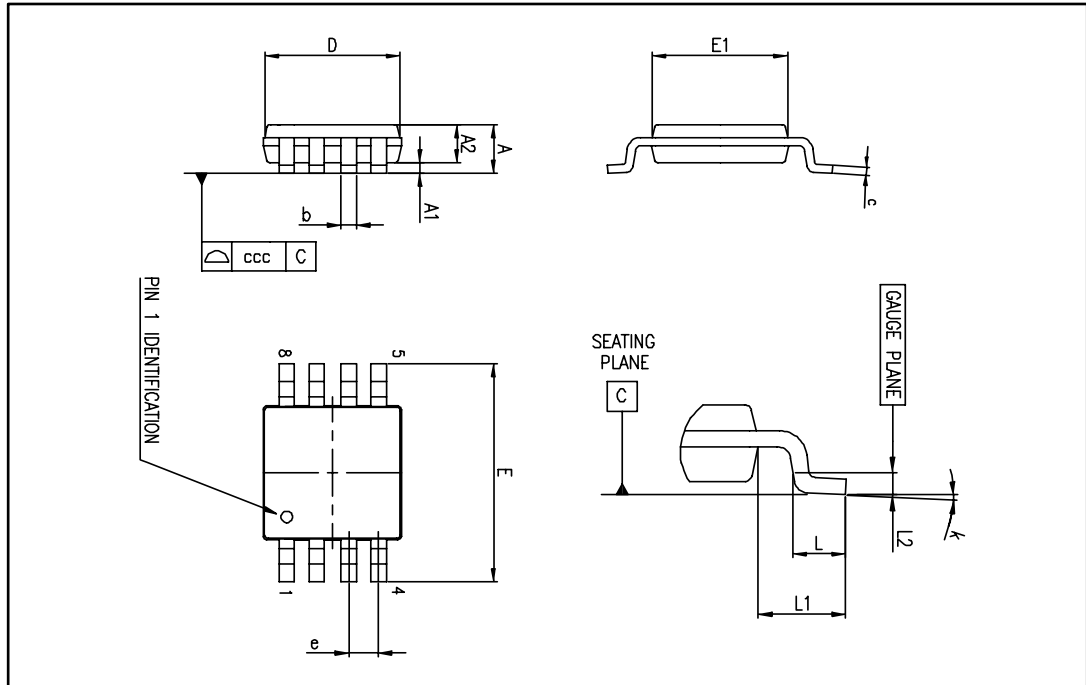

Table 11: MiniSO8 package mechanical data

Ref.	Dimensions					
	Millimeters			Inches		
	Min.	Typ.	Max.	Min.	Typ.	Max.
A			1.1			0.043
A1	0		0.15	0		0.006
A2	0.75	0.85	0.95	0.030	0.033	0.037
b	0.22		0.40	0.009		0.016
c	0.08		0.23	0.003		0.009
D	2.80	3.00	3.20	0.11	0.118	0.126
E	4.65	4.90	5.15	0.183	0.193	0.203
E1	2.80	3.00	3.10	0.11	0.118	0.122
e		0.65			0.026	
L	0.40	0.60	0.80	0.016	0.024	0.031
L1		0.95			0.037	
L2		0.25			0.010	
k	0°		8°	0°		8°
ccc			0.10			0.004

5.4 MiniSO10 package information

Figure 27: MiniSO10 package outline



Table 12: MiniSO-10 package mechanical data

Ref.	Dimensions					
	Millimeters			Inches		
	Min.	Typ.	Max.	Min.	Typ.	Max.
A			1.10			0.043
A1	0.05	0.10	0.15	0.002	0.004	0.006
A2	0.78	0.86	0.94	0.031	0.034	0.037
b	0.25	0.33	0.40	0.010	0.013	0.016
c	0.15	0.23	0.30	0.006	0.009	0.012
D	2.90	3.00	3.10	0.114	0.118	0.122
E	4.75	4.90	5.05	0.187	0.193	0.199
E1	2.90	3.00	3.10	0.114	0.118	0.122
e		0.50			0.020	
L	0.40	0.55	0.70	0.016	0.022	0.028
L1		0.95			0.037	
k	0°	3°	6°	0°	3°	6°
aaa			0.10			0.004

5.5 SO8 package information

Figure 28: SO8 package outline



Table 13: SO8 package mechanical data

Ref.	Dimensions					
	Millimeters			Inches		
	Min.	Typ.	Max.	Min.	Typ.	Max.
A			1.75			0.069
A1	0.10		0.25	0.004		0.010
A2	1.25			0.049		
b	0.28		0.48	0.011		0.019
c	0.17		0.23	0.007		0.010
D	4.80	4.90	5.00	0.189	0.193	0.197
E	5.80	6.00	6.20	0.228	0.236	0.244
E1	3.80	3.90	4.00	0.150	0.154	0.157
e		1.27			0.050	
h	0.25		0.50	0.010		0.020
L	0.40		1.27	0.016		0.050
L1		1.04			0.040	
k	1°		8°	1°		8°
ccc			0.10			0.004

5.6 QFN16 3x3 package information

Figure 29: QFN16 3x3 mm package outline



Table 14: QFN16 3x3 mm package mechanical data

Ref.	Dimensions					
	Millimeters			Inches		
	Min.	Typ.	Max.	Min.	Typ.	Max.
A	0.80	0.90	1.00	0.031	0.035	0.039
A1	0		0.05	0		0.002
A3		0.20			0.008	
b	0.18		0.30	0.007		0.012
D	2.90	3.00	3.10	0.114	0.118	0.122
D2	1.50		1.80	0.059		0.071
E	2.90	3.00	3.10	0.114	0.118	0.122
E2	1.50		1.80	0.059		0.071
e		0.50			0.020	
L	0.30		0.50	0.012		0.020

Figure 30: QFN16 3x3 mm recommended footprint



5.7 TSSOP14 package information

Figure 31: TSSOP14 package outline



Table 15: TSSOP14 package mechanical data

Ref.	Dimensions					
	Millimeters			Inches		
	Min.	Typ.	Max.	Min.	Typ.	Max.
A			1.20			0.047
A1	0.05		0.15	0.002	0.004	0.006
A2	0.80	1.00	1.05	0.031	0.039	0.041
b	0.19		0.30	0.007		0.012
c	0.09		0.20	0.004		0.0089
D	4.90	5.00	5.10	0.193	0.197	0.201
E	6.20	6.40	6.60	0.244	0.252	0.260
E1	4.30	4.40	4.50	0.169	0.173	0.176
e		0.65			0.0256	
L	0.45	0.60	0.75	0.018	0.024	0.030
L1		1.00			0.039	
k	0°		8°	0°		8°
aaa			0.10			0.004

5.8 TSSOP16 package information

Figure 32: TSSOP16 package outline



Table 16: TSSOP16 package mechanical data

Ref.	Dimensions					
	Millimeters			Inches		
	Min.	Typ.	Max.	Min.	Typ.	Max.
A			1.20			0.047
A1	0.05		0.15	0.002		0.006
A2	0.80	1.00	1.05	0.031	0.039	0.041
b	0.19		0.30	0.007		0.012
c	0.09		0.20	0.004		0.008
D	4.90	5.00	5.10	0.193	0.197	0.201
E	6.20	6.40	6.60	0.244	0.252	0.260
E1	4.30	4.40	4.50	0.169	0.173	0.177
e		0.65			0.026	
k	0°		8°	0°		8°
L	0.45	0.60	0.75	0.018	0.024	0.030
L1		1.00			0.039	
aaa			0.10			0.004

6 Ordering information

Table 17: Order codes

Order code	Temperature range	Package ⁽¹⁾	Marking
TSV632AIDT	-40 °C to 125 °C	SO8	TV632A
TSV632AILT		SOT23-8	K145
TSV632AIQ2T		DFN8 2x2	K1P
TSV632AIST		MiniSO8	K145
TSV632IDT		SO8	TSV632
TSV632ILT		SOT23-8	K110
TSV632IQ2T		DFN8 2x2	K1N
TSV632IST		MiniSO8	K110
TSV632IYDT	-40 °C to 125 °C, automotive grade ⁽²⁾	SO8	V632IY
TSV633AIST	-40 °C to 125 °C	MiniSO10	K146
TSV633IST			K111
TSV634AIPT		TSSOP14	TSV634A
TSV634IQ4T		QFN16 3x3	K112
TSV634IPT		TSSOP14	TSV634
TSV634IYPT	V634IY		
TSV635AIPT	-40 °C to 125 °C	TSSOP16	TSV635A
TSV635IPT			TSV635

Notes:

⁽¹⁾All devices are in tape and reel packing

⁽²⁾Qualified and characterized according to AEC Q100 and Q003 or equivalent, advanced screening according to AEC Q001 and Q002.

7 Revision history

Table 18: Document revision history

Date	Revision	Changes
25-May-2009	1	Initial release.
15-Jun-2009	2	Corrected pin connection diagram in Figure 1 .
03-Sep-2009	3	Added root part numbers (TSV63xA) and Table 1: "Device summary" on cover page. Added order code TSV632AILT in Table 17: "Order codes" .
07-Nov-2011	4	Added DFN8 2x2 package mechanical drawing. Added ordering information for DFN package to Table 17: "Order codes" . Corrected unit on Y axis of Figure 16 and Figure 17 .
13-Dec-2012	5	Updated Features Added QFN16 3x3 package Updated Figure 1: "Pin connections for each package (top view)" . Table 4 , Table 6 , and Table 7 : replaced DV_{io} symbol with $\Delta V_{io}/\Delta T$ Table 4 , Table 5 , Table 6 , Table 7 and Table 8 : for supply current parameter, replaced "operator" with "channel". Table 17: "Order codes" : added automotive order codes and updated footnote Deleted TSV632ID/AID from order codes in Table 17: "Order codes"
29-May-2015	6	Table 4 , Table 6 , and Table 7 : V_{OH} "min" values changed to "max" values. Table 17: "Order codes" : added order code TSV632AIQ2T, updated footnote 1.

IMPORTANT NOTICE – PLEASE READ CAREFULLY

STMicroelectronics NV and its subsidiaries (“ST”) reserve the right to make changes, corrections, enhancements, modifications, and improvements to ST products and/or to this document at any time without notice. Purchasers should obtain the latest relevant information on ST products before placing orders. ST products are sold pursuant to ST’s terms and conditions of sale in place at the time of order acknowledgement.

Purchasers are solely responsible for the choice, selection, and use of ST products and ST assumes no liability for application assistance or the design of Purchasers’ products.

No license, express or implied, to any intellectual property right is granted by ST herein.

Resale of ST products with provisions different from the information set forth herein shall void any warranty granted by ST for such product.

ST and the ST logo are trademarks of ST. All other product or service names are the property of their respective owners.

Information in this document supersedes and replaces information previously supplied in any prior versions of this document.

© 2015 STMicroelectronics – All rights reserved

单击下面可查看定价，库存，交付和生命周期等信息

[>>STMicro\(意法半导体\)](#)