

250 mA ultra low noise LDO

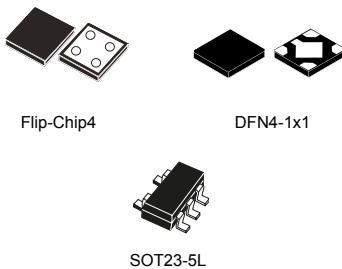

Features

- Ultra low output noise: 6.5 μV_{RMS}
- Operating input voltage range: 1.5 V to 5.5 V
- Output current up to 250 mA
- Very low quiescent current: 12 μA at no-load
- Controlled I_q in dropout condition
- Very low-dropout voltage: 250 mV at 250 mA
- Very high PSRR: 80 dB@100 Hz, 60 dB @ 100 kHz
- Output voltage accuracy: 2% across line, load and temperature
- Output voltage versions: from 1 V to 5 V, with 50 mV step
- Logic-controlled electronic shutdown
- Output discharge feature
- Internal soft-start
- Overcurrent and thermal protections
- Temperature range: from -40 °C to +125 °C
- Packages: Flip-Chip4, DFN4-1x1, SOT23-5L

Applications

- Smartphones/tablets
- Image sensors
- Instrumentation
- VCO and RF modules

Maturity status link

[LDLN025](#)

Description

The **LDLN025** is a 250 mA low-dropout voltage regulator, able to work with an input voltage range from 1.5 V to 5.5 V.

The typical dropout voltage at 250 mA load is 120 mV.

The very low quiescent current, which is just 12 μA at no-load, extends battery-life of applications requiring very long standby time.

Thanks to its ultra low noise value and high PSRR, the **LDLN025** provides a very clean output, suitable for ultra-sensitive loads. It is stable with ceramic capacitors.

The enable logic control function puts the device into shutdown mode allowing a total current consumption lower than 1 μA .

The device also includes short-circuit and thermal protection.

Typical applications are noise sensitive loads such as ADC, VCO in mobile phones and tablets, wireless LAN devices. The **LDLN025** is designed to keep the quiescent current under control and at a low value also during dropout operation, extending the operating time of battery-powered devices.

Several small package options are available.

1 Block diagram

Figure 1. Block diagram

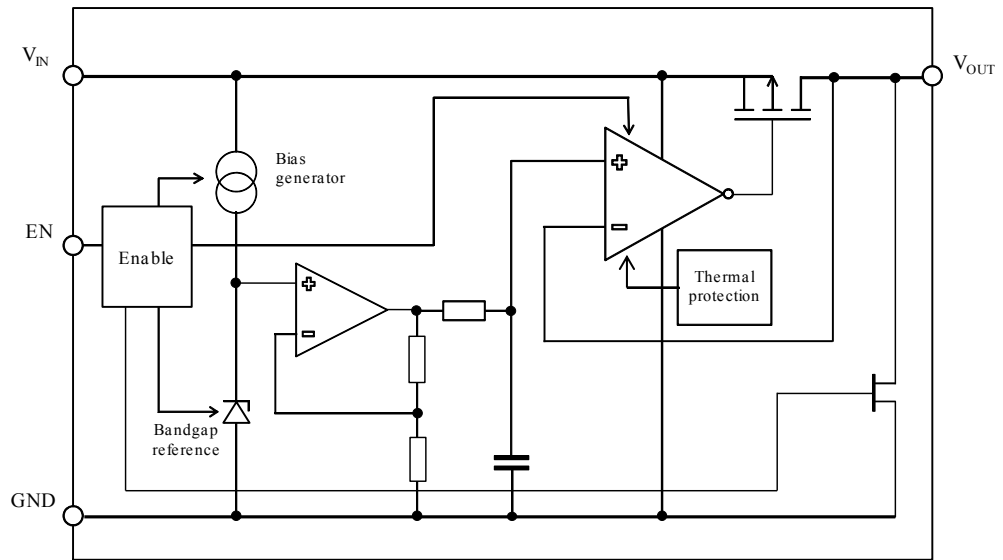

AMG280620171000MT

2 Pin configuration

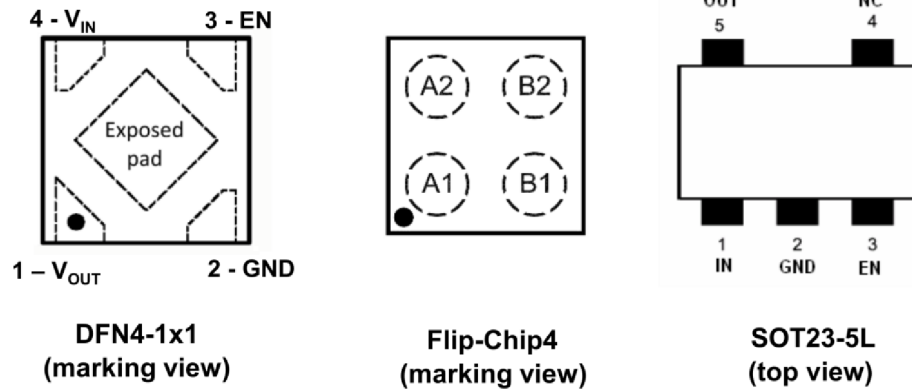
Figure 2. Pin configuration

Table 1. Pin description

Symbol	DFN4-1x1	Flip-Chip4	SOT23-5L	Description
V_{IN}	4	A1	1	LDO Supply voltage
V_{OUT}	1	A2	5	LDO Output voltage
GND	2	B2	2	Ground
EN	3	B1	3	Enable input: set V_{EN} = high to turn on the device; V_{EN} = low to turn off the device This pin is internally pulled down via 1 M Ω resistor
NC	-	-	4	Not internally connected: can be connected to GND
Exposed pad	Exposed pad	-	-	Must be connected to GND

3 Typical application diagram

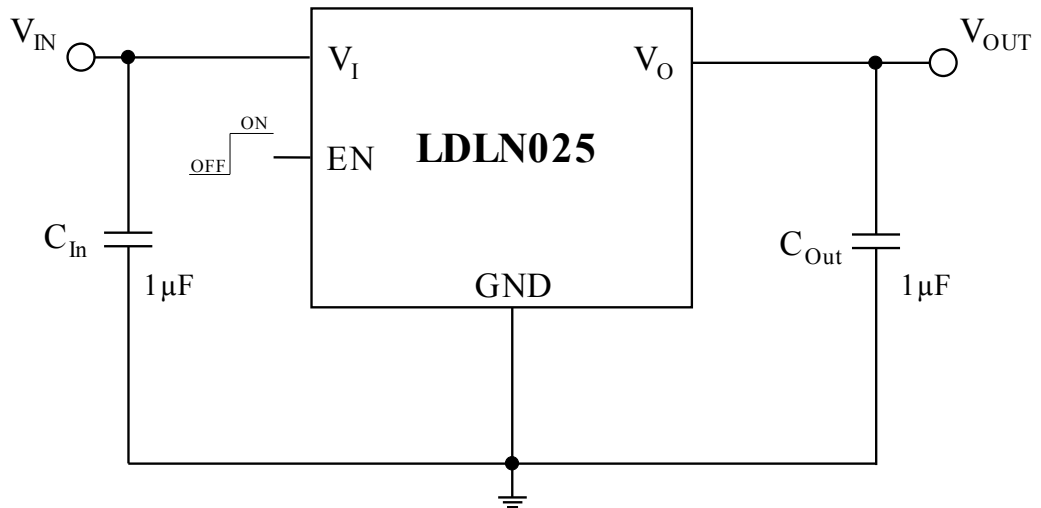
Figure 3. Typical application diagram



AMG010720161412MT

4 Maximum ratings

Table 2. Absolute maximum ratings

Symbol	Parameter	Value	Unit
V_{IN}	Input supply voltage	-0.3 to 7	V
V_{OUT}	Output voltage	-0.3 to $V_{IN} + 0.3$	V
I_{OUT}	Output current	Internally limited	A
EN	Enable pin voltage	-0.3 to $V_{IN} + 0.3$	V
P_D	Power dissipation	Internally limited	W
ESD	Charge device model	± 1000	V
	Human body model	± 2000	
T_{J-OP}	Operating junction temperature	-40 to 125	$^{\circ}C$
T_{J-MAX}	Maximum junction temperature	150	$^{\circ}C$
T_{STG}	Storage temperature	-55 to 150	$^{\circ}C$

Table 3. Thermal data

Symbol	Parameter	DFN4-1x1	Flip-Chip4	SOT23-5L	Unit
R_{thja}	Thermal resistance, junction-to-ambient	220	210	200	$^{\circ}C/W$

5 Electrical characteristics

($T_J = 25\text{ }^\circ\text{C}$, $V_{IN} = V_{OUT(nom)} + 1\text{ V}$ or 1.5 V , whichever is greater; $V_{EN} = 1.2\text{ V}$; $C_{IN} = 1\text{ }\mu\text{F}$; $C_{OUT} = 1\text{ }\mu\text{F}$; $I_{OUT} = 1\text{ mA}$)

Table 4. Electrical characteristics

Symbol	Parameter	Test conditions	Min.	Typ.	Max.	Unit
V_{IN}	Operating input voltage range		1.5		5.5	V
V_{OUT}	Output voltage accuracy (Flip-Chip package)	$V_{OUT} + 1\text{ V} < V_{IN} < 5.5\text{ V}$, ⁽¹⁾ $1\text{ mA} < I_{OUT} < 0.25\text{ A}$, $V_{OUT} \geq 1.8\text{ V}$, $-40\text{ }^\circ\text{C} < T_J < 125\text{ }^\circ\text{C}$	-2.0		+2.0	%
		$V_{OUT} + 1\text{ V} < V_{IN} < 5.5\text{ V}$, ⁽¹⁾ $1\text{ mA} < I_{OUT} < 0.25\text{ A}$, $V_{OUT} < 1.8\text{ V}$, $-40\text{ }^\circ\text{C} < T_J < 125\text{ }^\circ\text{C}$	-3.0		+3.0	
V_{OUT}	Output voltage accuracy (DFN and SOT23 packages)	$V_{OUT} + 1\text{ V} < V_{IN} < 5.5\text{ V}$, ⁽¹⁾ $1\text{ mA} < I_{OUT} < 0.25\text{ A}$, $V_{OUT} \geq 1.8\text{ V}$, $-40\text{ }^\circ\text{C} < T_J < 125\text{ }^\circ\text{C}$	-2.0		+2.0	%
		$V_{OUT} + 1\text{ V} < V_{IN} < 5.5\text{ V}$, ⁽¹⁾ $1\text{ mA} < I_{OUT} < 0.25\text{ A}$, $V_{OUT} < 1.8\text{ V}$, $-40\text{ }^\circ\text{C} < T_J < 125\text{ }^\circ\text{C}$	-4.0		+4.0	
$\frac{\Delta V_{OUT}}{\Delta V_{IN}}$	Static line regulation	$V_{OUT} + 1\text{ V} < V_{IN} < 5.5\text{ V}$, ⁽¹⁾ $-40\text{ }^\circ\text{C} < T_J < 125\text{ }^\circ\text{C}$		0.02		%V
	Line transient ⁽²⁾	$\Delta V_{IN} = \pm 0.6\text{ V}$, $t_{rise} = t_{fall} = 30\text{ }\mu\text{s}$	-1		+1	
$\frac{\Delta V_{OUT}}{\Delta I_{OUT}}$	Static load regulation	$1\text{ mA} < I_{OUT} < 0.25\text{ A}$, $V_{OUT} \geq 1.8\text{ V}$ $-40\text{ }^\circ\text{C} < T_J < 125\text{ }^\circ\text{C}$, $V_{OUT} \geq 1.8\text{ V}$		0.002		%mA
		$1\text{ mA} < I_{OUT} < 0.25\text{ A}$, $V_{OUT} < 1.8\text{ V}$		20		
	Load transient ⁽²⁾	$\Delta I_{OUT} = 1\text{ mA}$ to 250 mA and back, $t_{rise} = t_{fall} = 10\text{ }\mu\text{s}$	-40		+40	mV
ΔV_{OUT}	Overshoot on startup ⁽²⁾	Percentage of $V_{OUT(nom)}$			5	%
V_{DROP}	Dropout voltage ⁽³⁾	$I_{OUT} = 0.1\text{ A}$		50		mV
		$I_{OUT} = 0.25\text{ A}$		120		
		$I_{OUT} = 0.25\text{ A}$, $-40\text{ }^\circ\text{C} < T_J < 125\text{ }^\circ\text{C}$ (Flip-Chip ⁴)			200	
		$I_{OUT} = 0.25\text{ A}$, $-40\text{ }^\circ\text{C} < T_J < 125\text{ }^\circ\text{C}$ (DFN4-1x1)			250	
eN	Output noise voltage ⁽²⁾	$f = 10\text{ Hz}$ to 100 kHz ; $I_{OUT} = 1\text{ mA}$		10		μV_{RMS}
		$f = 10\text{ Hz}$ to 100 kHz ; $I_{OUT} = 250\text{ mA}$		6.5		

Symbol	Parameter	Test conditions	Min.	Typ.	Max.	Unit
SVR	Supply voltage rejection ⁽²⁾	f = 100 Hz; I _{OUT} = 20 mA		80		dB
		f = 1 kHz; I _{OUT} = 20 mA		80		
		f = 10 kHz; I _{OUT} = 20 mA		75		
		f = 100 kHz; I _{OUT} = 20 mA		60		
I _Q	Quiescent current ⁽⁴⁾	I _{OUT} = 0 A		12		μA
		I _{OUT} = 0 A; -40 °C < T _J < 125 °C			25	
		I _{OUT} = 0.25 A		250		μA
	I _{OUT} = 0.25 A; -40 °C < T _J < 125 °C			425		
	Shutdown current	V _{EN} = 0 V		0.2	1	μA
I _{SC}	Short-circuit current	V _{OUT} = 0 V	250	500		mA
R _{LOW}	Output discharge resistance	V _{EN} = 0 V		230		Ω
V _{EN}	V _{IL} , enable input logic low	V _{OUT} + 1 V < V _{IN} < 5.5 V -40 °C < T _J < 125 °C ⁽¹⁾			0.4	V
	V _{IH} , enable input logic high		1.2			
I _{EN}	Enable pin input current	V _{IN} = V _{EN} = 5.5 V		5.5		μA
		V _{IN} = 5.5 V; V _{EN} = 0 V		0.001		
t _{ON}	Turn-on time ⁽²⁾	From V _{EN} > V _{IH} to V _{OUT} = 95 % of V _{OUT(nom)}		80	150	μs
T _{SHDN}	Thermal shutdown ⁽²⁾	I _{OUT} > 1 mA		160		°C
	Hysteresis			20		

1. V_{IN} = V_{OUT} + 1 V or 1.5 V, whichever is greater. Not applicable for 5 V output voltage versions.
2. Guaranteed by design.
3. Dropout voltage is the input-to-output voltage difference at which the output voltage is 100 mV below its nominal value.
4. The quiescent current is defined as I_{IN}-I_{OUT} and does not include the EN pin current.

Table 5. Recommended input and output capacitors

Symbol	Parameter	Test conditions	Min.	Typ.	Max.	Unit
C _{IN}	Input capacitance	Stability	0.7	1		μF
C _{OUT}	Output capacitance		0.7	1	10	
ESR	Output/input capacitance		5		500	mΩ

6 Typical characteristics

(The following plots are referred to LDLN025J2925R in the typical application circuit and, unless otherwise noted, at $T_A = 25^\circ\text{C}$).

Figure 4. Output voltage vs. temperature ($V_{IN} = 3.925\text{ V}$)

$V_{IN} = V_{OUT} + 1\text{ V}$, $E_N = 2\text{ V}$, $I_{OUT} = \text{from } 0 \text{ to } 250\text{ mA}$, $C_{IN} = 1\ \mu\text{F}$, $C_{OUT} = 1\ \mu\text{F}$

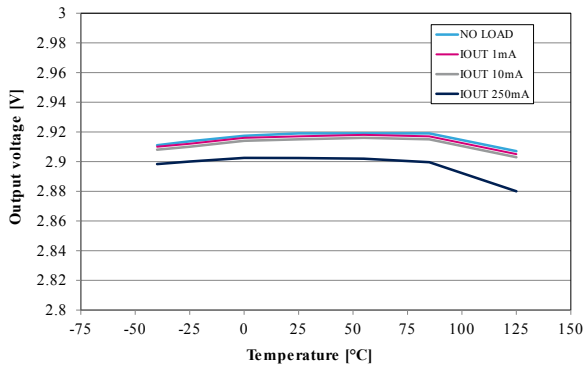

AMG010720161030MT

Figure 5. Output voltage vs. temperature ($V_{IN} = 5.5\text{ V}$)

$V_{IN} = 5.5\text{ V}$; $I_{OUT} = \text{from } 0 \text{ to } 250\text{ mA}$, $C_{IN} = 1\ \mu\text{F}$, $C_{OUT} = 1\ \mu\text{F}$

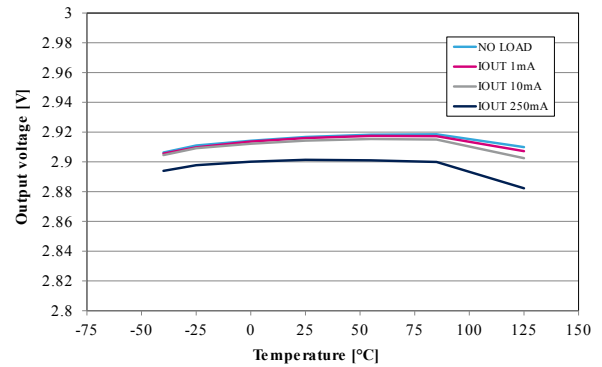

AMG010720161031MT

Figure 6. Load regulation vs. temperature

$V_{IN} = V_{OUT} + 1\text{ V}$; $I_{OUT} = \text{from } 1\text{ mA to } 0.25\text{ A}$, $C_{IN} = 1\ \mu\text{F}$, $C_{OUT} = 1\ \mu\text{F}$

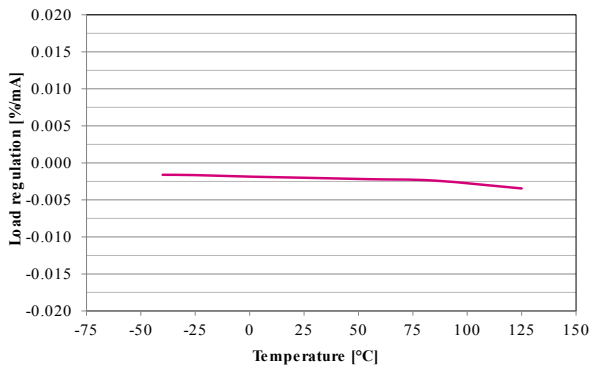

AMG010720161032MT

Figure 7. Line regulation vs. temperature

$V_{IN} = \text{from } 3.925 \text{ to } 5.5\text{ V}$, $I_{OUT} = 1\text{ mA}$, $C_{IN} = 1\ \mu\text{F}$, $C_{OUT} = 1\ \mu\text{F}$

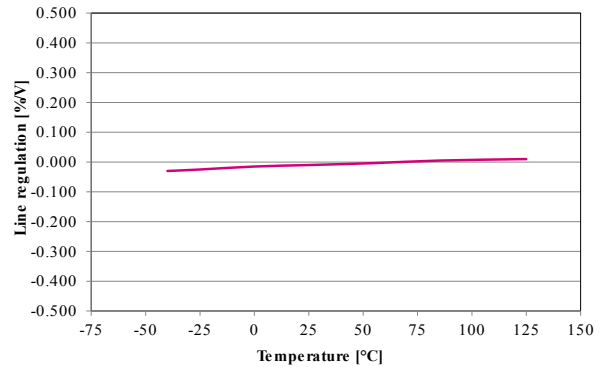

AMG010720161033MT

Figure 8. Quiescent current vs. temperature ($I_{OUT} = 0$ mA)

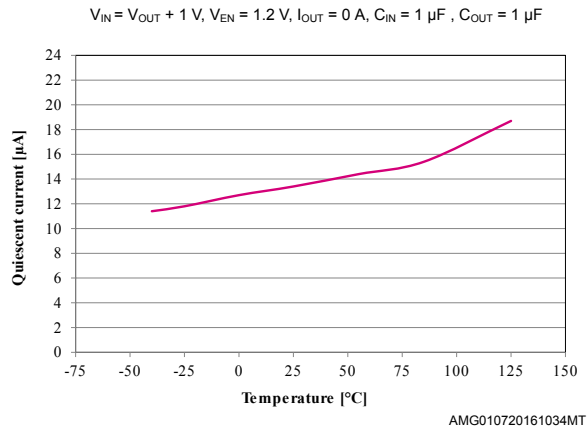

Figure 9. Quiescent current vs. temperature ($I_{OUT} = 250$ mA)

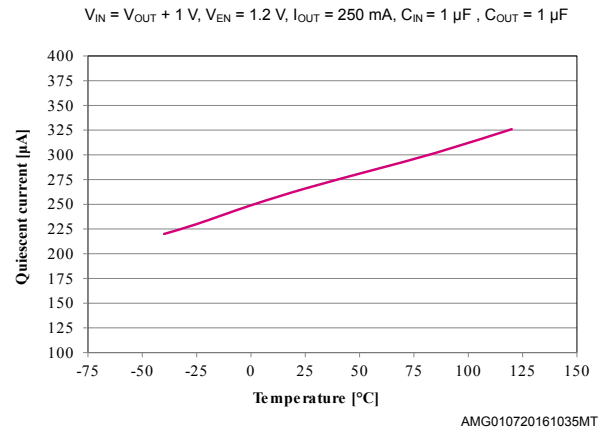

Figure 10. GND current vs. input voltage

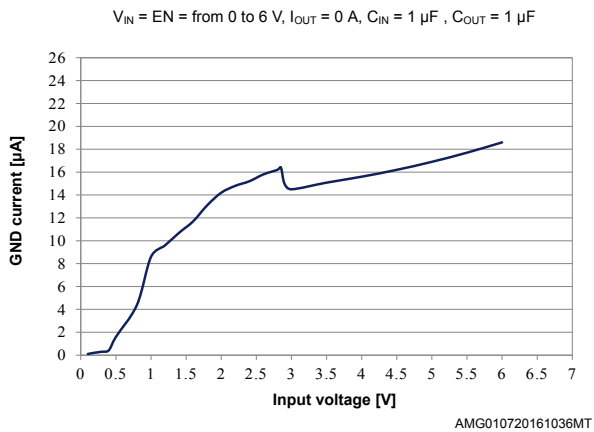

Figure 11. Off-state current vs. temperature

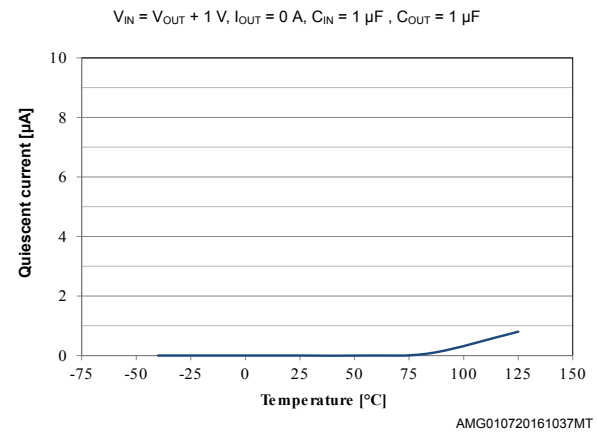

Figure 12. Quiescent current vs. output current

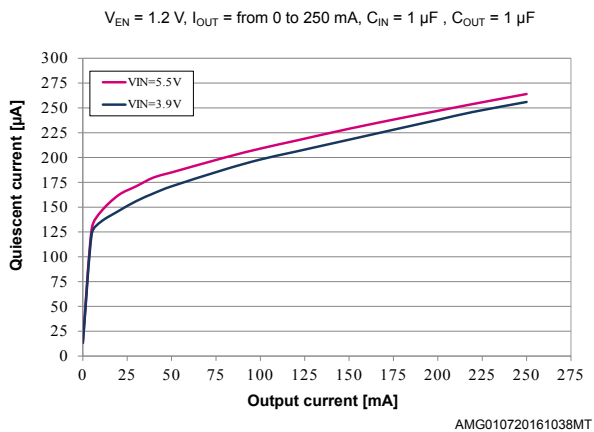

Figure 13. Quiescent current vs. output current (zoom)

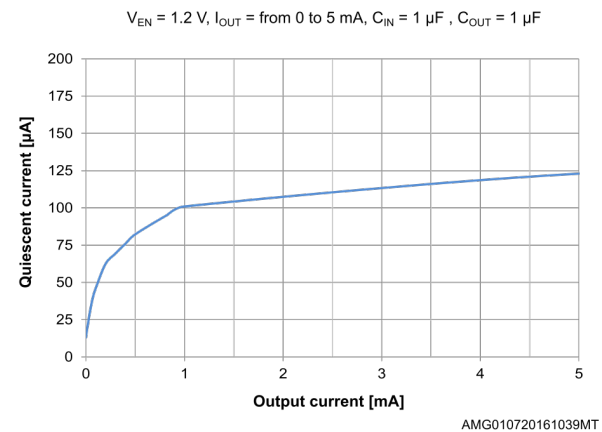

Figure 14. Dropout voltage vs. temperature

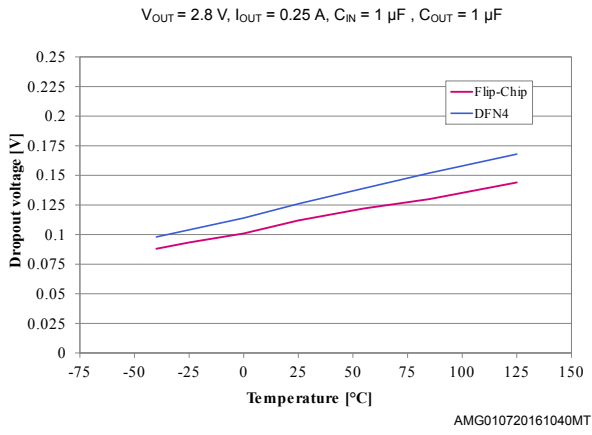

Figure 15. Dropout voltage vs. load current

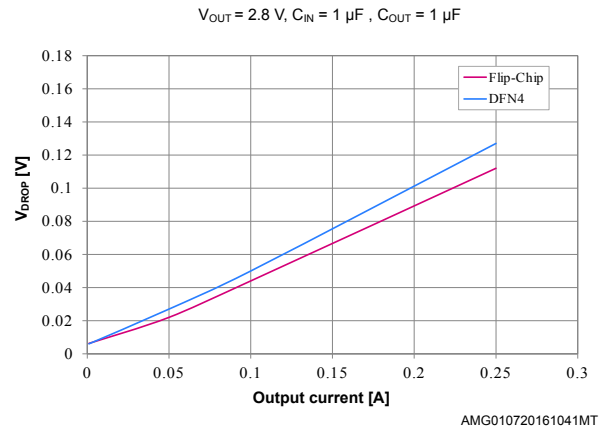

Figure 16. Output voltage vs. input voltage

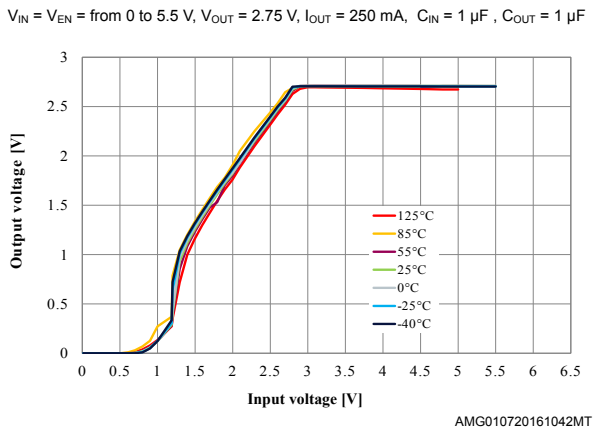

Figure 17. Short circuit current vs. dropout voltage

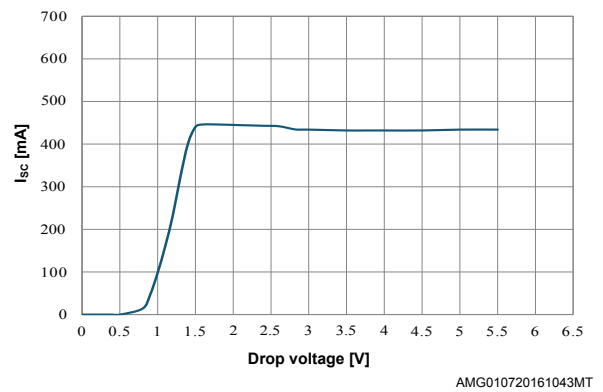

Figure 18. Enable threshold vs. temperature

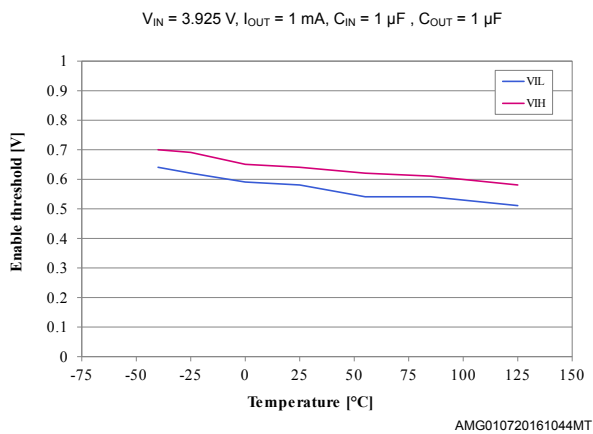

Figure 19. Stability region vs. C_{OUT} and ESR

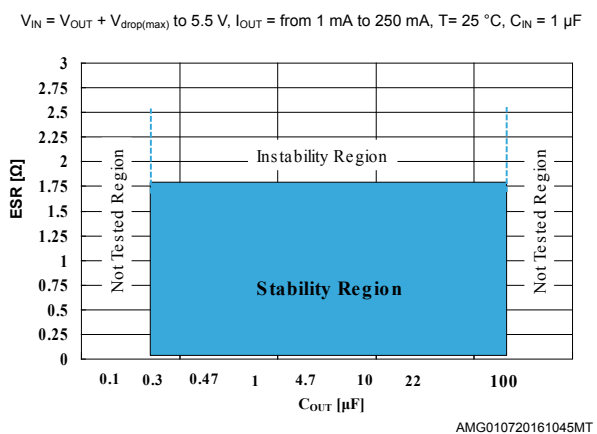
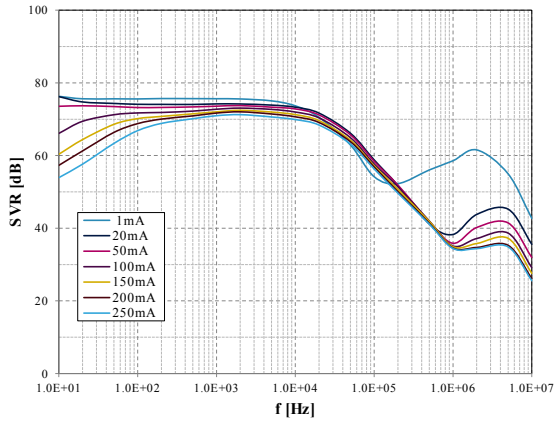

Figure 20. PSRR vs. frequency ($V_{OUT} = 2.75\text{ V}$)



$V_{IN} = 3.75\text{ V} + V_{\text{ripple}}$, $V_{OUT} = 2.75\text{ V}$, no C_{IN} , $C_{OUT} = 1\text{ }\mu\text{F}$, $V_{EN} = 1.2\text{ V}$

AMG010720161046MT

Figure 21. PSRR vs. frequency ($V_{OUT} = 1.8\text{ V}$)

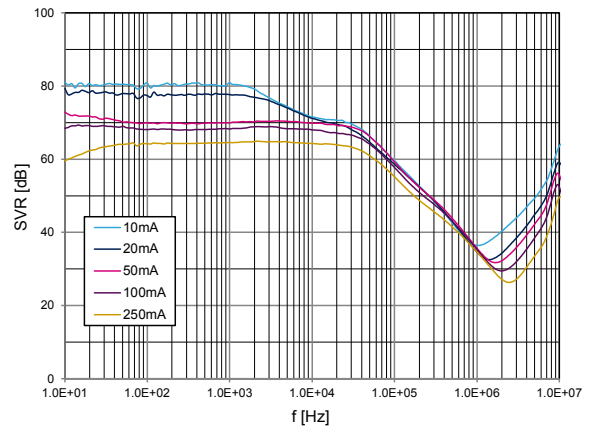

$V_{IN} = 2.5\text{ V} + V_{\text{ripple}}$, $V_{OUT} = 1.8\text{ V}$, no C_{IN} , $C_{OUT} = 1\text{ }\mu\text{F}$, $V_{EN} = 1.2\text{ V}$

Figure 22. PSRR vs. frequency ($V_{OUT} = 5\text{ V}$)

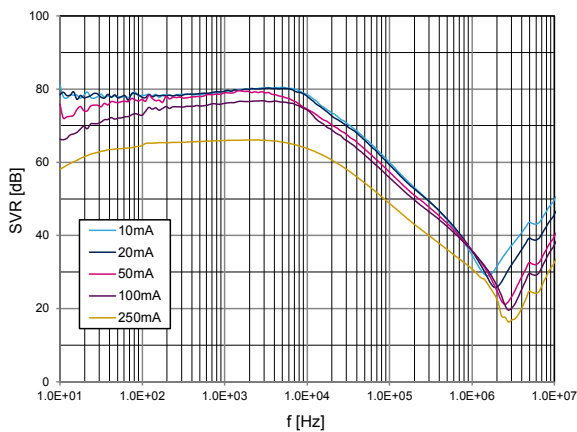

$V_{IN} = 5\text{ V} + V_{\text{ripple}}$, $V_{OUT} = 5\text{ V}$, no C_{IN} , $C_{OUT} = 1\text{ }\mu\text{F}$, $V_{EN} = 1.2\text{ V}$

Figure 23. Noise density

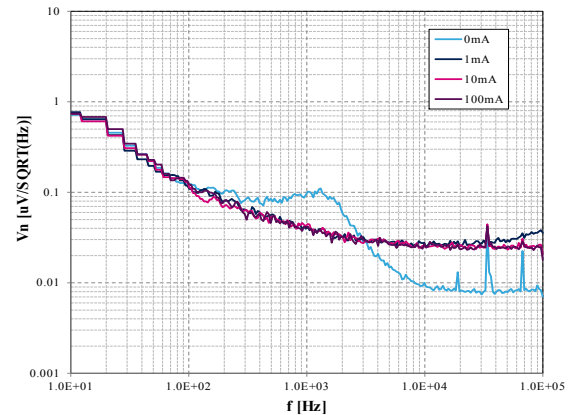

$V_{IN} = 3.75\text{ V}$, $V_{OUT} = 2.75\text{ V}$, $C_{IN} = C_{OUT} = 1\text{ }\mu\text{F}$

AMG010720161047MT

Figure 24. Line transient ($I_{OUT} = 1\text{ mA}$)

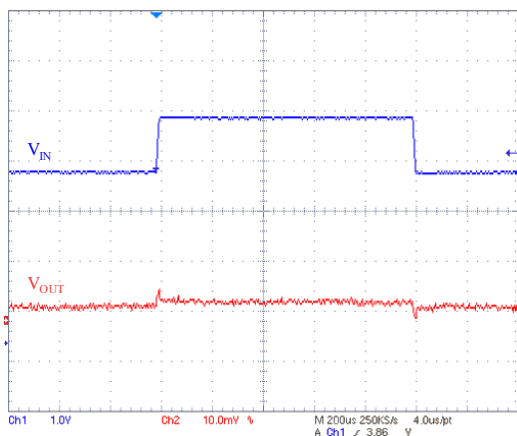

V_{IN} = from 3.4 V to 4.4 V, $I_{OUT} = 1\text{ mA}$, $t_r = 10\text{ }\mu\text{s}$, $C_{IN} = C_{OUT} = 1\text{ }\mu\text{F}$ (X7R)

AMG010720161048MT

Figure 25. Line transient ($I_{OUT} = 250\text{ mA}$)



V_{IN} = from 3.4 V to 4.4 V, $I_{OUT} = 250\text{ mA}$, $t_r = 10\text{ }\mu\text{s}$, $C_{IN} = C_{OUT} = 1\text{ }\mu\text{F}$ (X7R)

AMG010720161049MT

Figure 26. Load transient

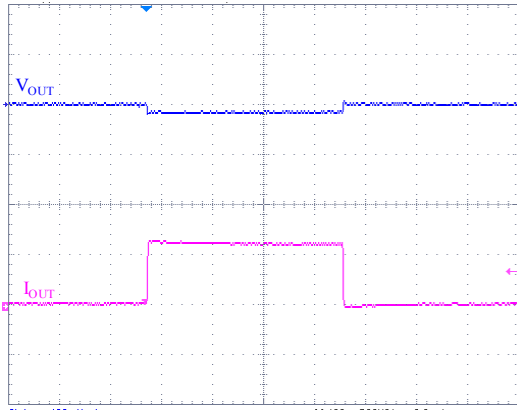

I_{OUT} = from 0 mA to 250 mA, t_r = 10 μ s, C_{IN} = C_{OUT} = 1 μ F (X7R)

AMG010720161050MT

Figure 27. Inrush current

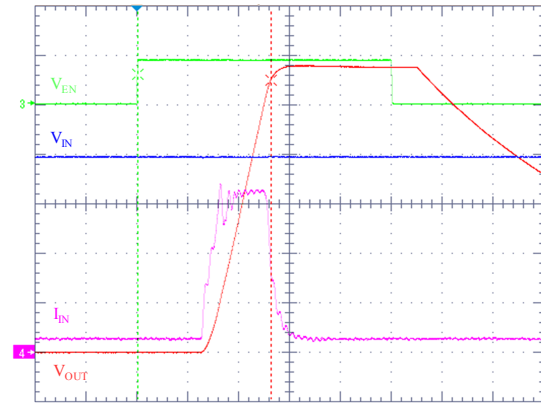

V_{IN} = 4 V, I_{OUT} = 0 mA, C_{IN} = C_{OUT} = 1 μ F (X7R)

AMG180720161000MT

Figure 28. Enable transient (I_{OUT} = 0 mA)

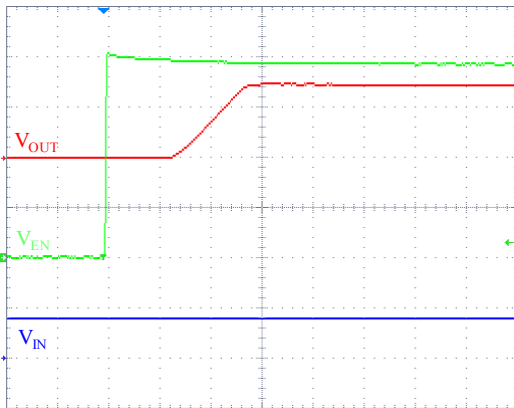

V_{IN} = 3.925 V, V_{EN} = from 0 V to 3.925 V, I_{OUT} = 0 mA, t_r = 1 μ s, C_{IN} = C_{OUT} = 1 μ F (X7R)

AMG010720161052MT

Figure 29. Enable transient (I_{OUT} = 250 mA)

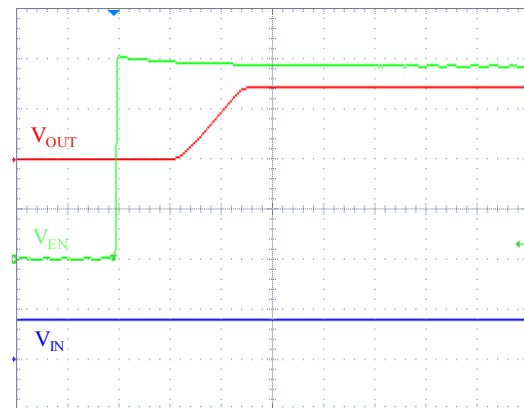

V_{IN} = 3.925 V, V_{EN} = from 0 V to 3.925 V, I_O = 250 mA, t_r = 1 μ s, C_{IN} = C_{OUT} = 1 μ F (X7R)

AMG010720161053MT

7 Package information

In order to meet environmental requirements, ST offers these devices in different grades of **ECOPACK** packages, depending on their level of environmental compliance. ECOPACK specifications, grade definitions and product status are available at: www.st.com. ECOPACK is an ST trademark.

7.1 Flip-Chip4 package information

Figure 30. Flip-Chip4 package outline

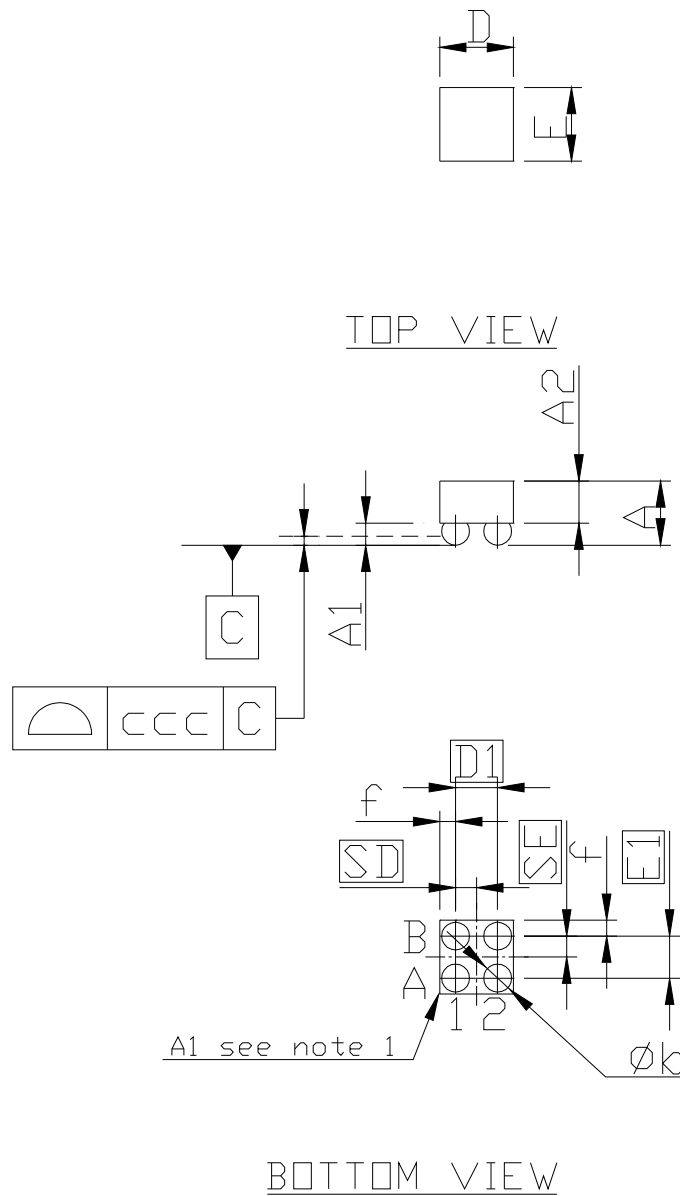

8387748 option F

Table 6. Flip-Chip4 mechanical data

Dim.	mm		
	Min.	Typ.	Max.
A	0.375	0.410	0.445
A1	0.145	0.160	0.175
A2 ⁽¹⁾	0.230	0.250	0.270
b	0.189	0.210	0.231
D	0.598	0.628	0.658
D1		0.350	
E	0.598	0.628	0.658
E1		0.350	
SD		0.175	
SE		0.175	
f		0.139	
ccc		0.075	

1. Including back coating.

Figure 31. Flip-Chip4 recommended footprint

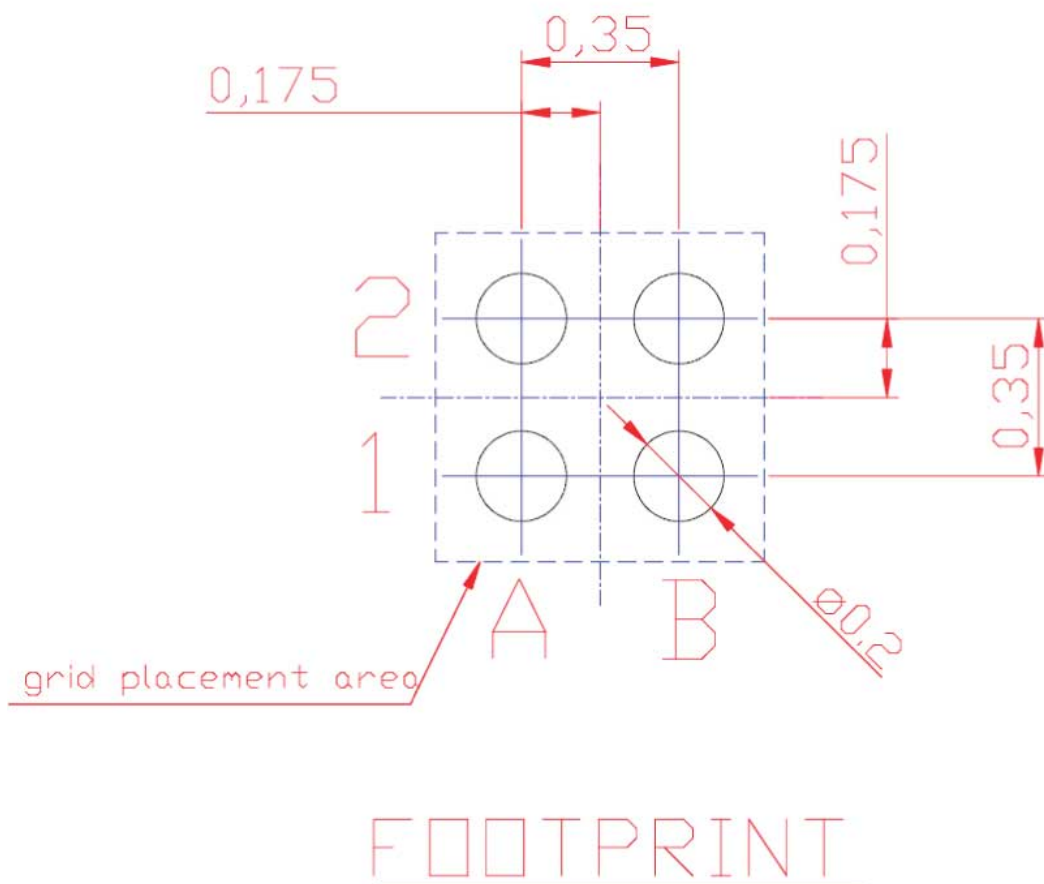

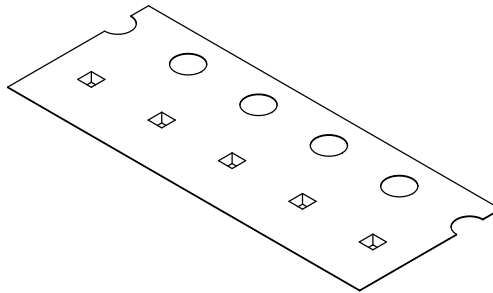
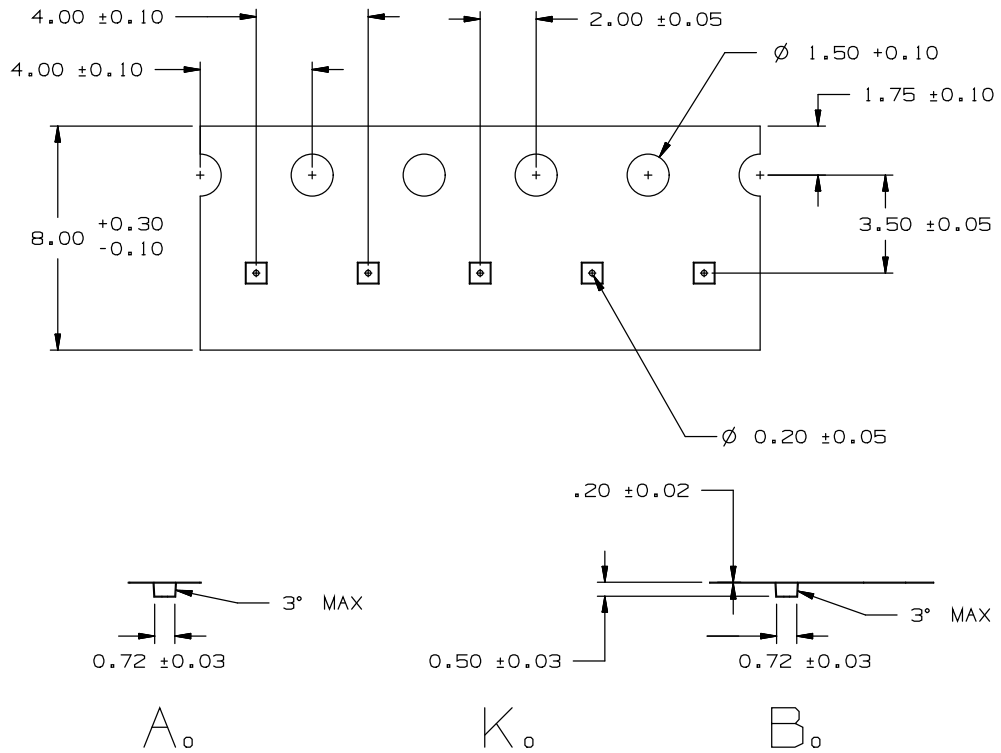
7.2 Flip-Chip4_160304-47_carrier_tape
Figure 32. Flip-Chip4 carrier tape

7.3 DFN4-1x1 package info

Figure 33. DFN4-1x1 package outline

BOTTOM VIEW

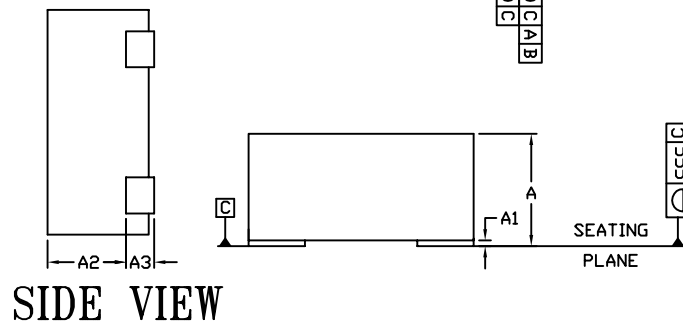
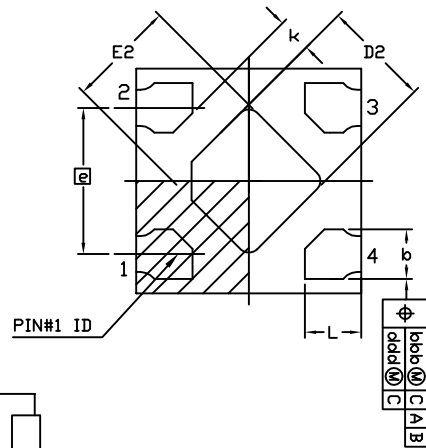

SIDE VIEW

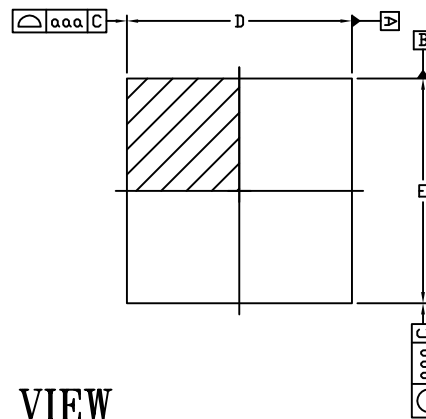

TOP VIEW

8405587

Table 7. DFN4-1x1 package mechanical data

Dim.	mm		
	Min.	Typ.	Max.
A	0.36		0.40
A1	0.00		0.05
A2	0.15	0.25	0.35
A3		0.125	
b	0.15	0.20	0.25
D	0.95	1.00	1.05
D2	0.38	0.48	0.58
e		0.65	
E	0.95	1.00	1.05
E2	0.38	0.48	0.58
L	0.15	0.25	0.35
K		0.15	
N		4	

Figure 34. DFN4-1x1 recommended footprint

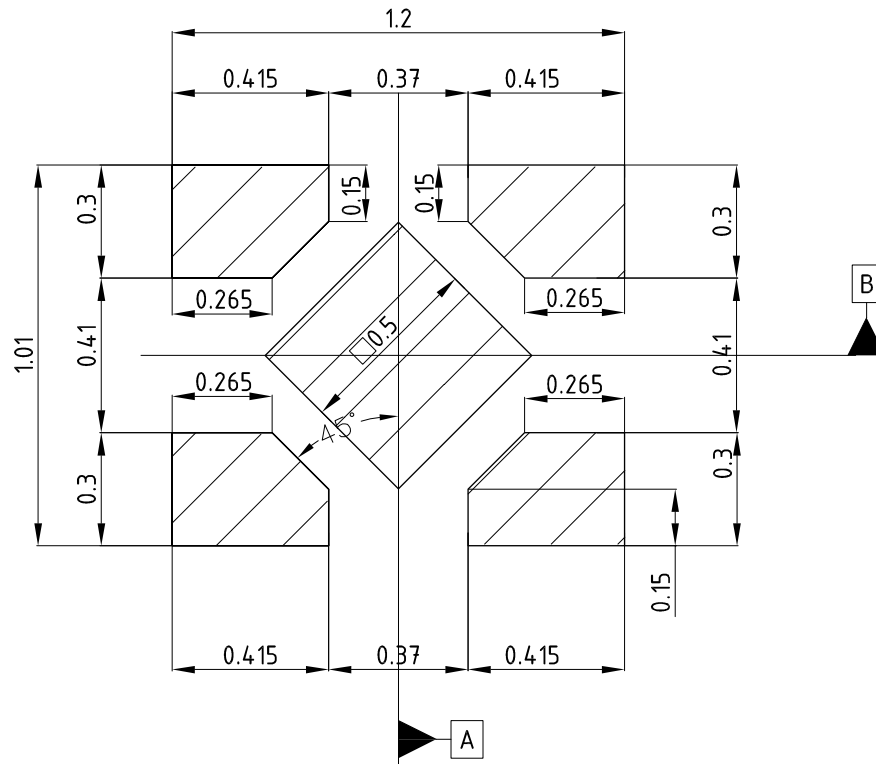

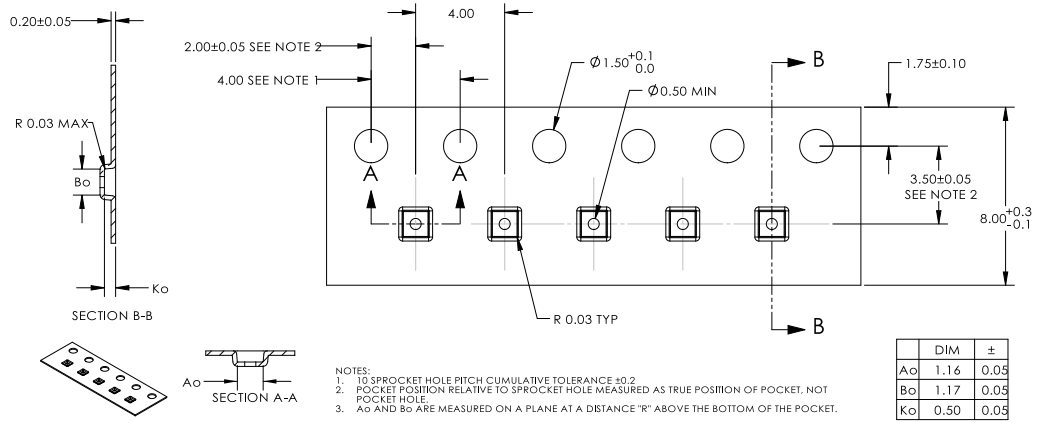
7.4 DFN4_1x1x0.38_pitch_4mm_carrier_tape
Figure 35. DFN4 (1x1x0.38 pitch 4 mm) carrier tape

7.5 SOT23-5L mechanical data

Figure 36. SOT23-5L package outline

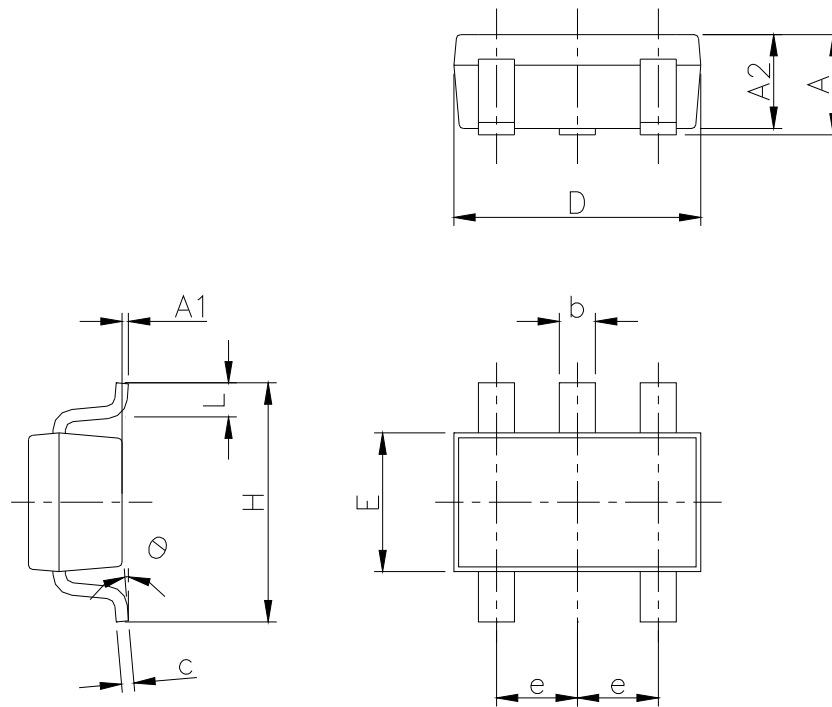

7049676_k

Table 8. SOT23-5L package mechanical data

Dim.	mm		
	Min.	Typ.	Max.
A	0.90		1.45
A1	0		0.15
A2	0.90		1.30
b	0.30		0.50
c	0.09		0.20
D		2.95	
E		1.60	
e		0.95	
H		2.80	
L	0.30		0.60
θ	0°		8°

Figure 37. SOT23-5L recommended footprint

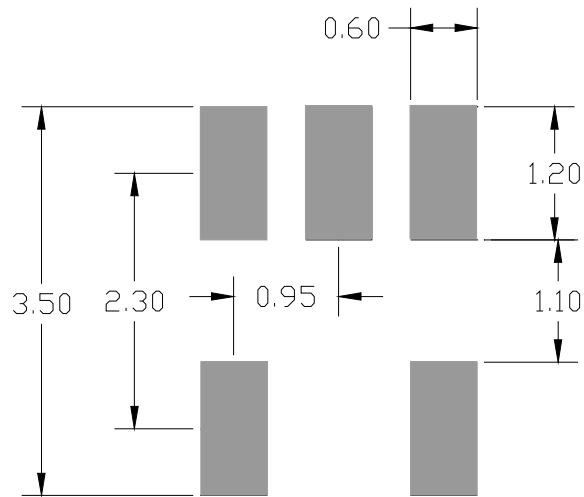

Note: Dimensions are in mm

8 Ordering information

Table 9. Order code

Order code	Package	Output voltage (V)	Marking	Packing
LDLN025PU12R	DFN4-1x1	1.2	12	Tape and reel
LDLN025PU18R		1.8	18	
LDLN025PU25R		2.5	25	
LDLN025PU275R		2.75	2Z	
LDLN025PU28R		2.8	28	
LDLN025PU29R		2.9	29	
LDLN025PU30R		3.0	30	
LDLN025PU32R		3.2	32	
LDLN025PU33R		3.3	33	
LDLN025PU50R		5.0	50	
LDLN025J12R		Flip-Chip4	1.2	
LDLN025J18R	1.8		E	
LDLN025J25R	2.5		H	
LDLN025J28R	2.8		I	
LDLN025J29R	2.9		S	
LDLN025J2925R	2.925		K	
LDLN025J30R ⁽¹⁾	3.0		G	
LDLN025J32R	3.2		N	
LDLN025J33R	3.3		F	
LDLN025J50R	5.0		P	
LDLN025M12R	SOT23-5L		1.2	
LDLN025M15R		1.5	LN15	
LDLN025M18R		1.8	LN18	
LDLN025M25R		2.5	LN25	
LDLN025M28R		2.8	LN28	
LDLN025M30R		3.0	LN30	
LDLN025M33R		3.3	LN33	
LDLN025M45R		4.5	LN45	

1. Part number in development. Contact our sales office.

8.1 Marking information

Figure 38. Flip-Chip marking composition (marking view)

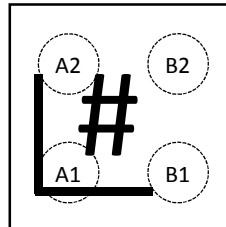

AMG260720161100MT

Note: the symbol # indicates the marking digit, as per [Table 9. Order code](#).

Revision history

Table 10. Document revision history

Date	Revision	Changes
03-Aug-2016	1	First release.
01-Sep-2016	2	Updated Table 8: "Order code". Minor text changes.
24-Oct-2016	3	Updated Table 2: "Absolute maximum ratings". Minor text changes.
17-Nov-2016	4	Updated Section 9: "Ordering information". Minor text changes.
12-Jul-2017	5	Added SOT23-5L package. Modified silhouette, features, Figure 1: "Block diagram", Section 2: "Pin configuration" and Table 4: "Electrical characteristics". Added Section 7.5: "SOT23-5L package information". Updated Table 9: "Order code". Minor text changes.
09-Oct-2018	6	Added Figure 21. PSRR vs. frequency ($V_{OUT} = 1.8\text{ V}$), Figure 22. PSRR vs. frequency ($V_{OUT} = 5\text{ V}$), new order codes LDLN025PU12R and LDLN025J29R in Table 9. Order code.
08-May-2019	7	Added footnote on A2 parameter in Table 6. Flip-Chip4 mechanical data .

Contents

1	Block diagram	2
2	Pin configuration	3
3	Typical application diagram	4
4	Maximum ratings	5
5	Electrical characteristics	6
6	Typical characteristics	8
7	Package information	13
7.1	Flip-Chip4 package information	13
7.2	Flip-Chip4 packing information	14
7.3	DFN4-1x1 package information	15
7.4	DFN4-1x1 packing information	18
7.5	SOT23-5L package information	19
8	Ordering information	21
8.1	Marking information	21
	Revision history	23
	Contents	24
	List of tables	25
	List of figures	26

List of tables

Table 1.	Pin description	3
Table 2.	Absolute maximum ratings	5
Table 3.	Thermal data	5
Table 4.	Electrical characteristics	6
Table 5.	Recommended input and output capacitors	7
Table 6.	Flip-Chip4 mechanical data	14
Table 7.	DFN4-1x1 package mechanical data	17
Table 8.	SOT23-5L package mechanical data	19
Table 9.	Order code	21
Table 10.	Document revision history	23

List of figures

Figure 1.	Block diagram	2
Figure 2.	Pin configuration	3
Figure 3.	Typical application diagram	4
Figure 4.	Output voltage vs. temperature ($V_{IN} = 3.925\text{ V}$)	8
Figure 5.	Output voltage vs. temperature ($V_{IN} = 5.5\text{ V}$)	8
Figure 6.	Load regulation vs. temperature	8
Figure 7.	Line regulation vs. temperature	8
Figure 8.	Quiescent current vs. temperature ($I_{OUT} = 0\text{ mA}$)	9
Figure 9.	Quiescent current vs. temperature ($I_{OUT} = 250\text{ mA}$)	9
Figure 10.	GND current vs. input voltage	9
Figure 11.	Off-state current vs. temperature	9
Figure 12.	Quiescent current vs. output current	9
Figure 13.	Quiescent current vs. output current (zoom)	9
Figure 14.	Dropout voltage vs. temperature	10
Figure 15.	Dropout voltage vs. load current	10
Figure 16.	Output voltage vs. input voltage	10
Figure 17.	Short circuit current vs. dropout voltage	10
Figure 18.	Enable threshold vs. temperature	10
Figure 19.	Stability region vs. C_{OUT} and ESR	10
Figure 20.	PSRR vs. frequency ($V_{OUT} = 2.75\text{ V}$)	11
Figure 21.	PSRR vs. frequency ($V_{OUT} = 1.8\text{ V}$)	11
Figure 22.	PSRR vs. frequency ($V_{OUT} = 5\text{ V}$)	11
Figure 23.	Noise density	11
Figure 24.	Line transient ($I_{OUT} = 1\text{ mA}$)	11
Figure 25.	Line transient ($I_{OUT} = 250\text{ mA}$)	11
Figure 26.	Load transient	12
Figure 27.	Inrush current	12
Figure 28.	Enable transient ($I_{OUT} = 0\text{ mA}$)	12
Figure 29.	Enable transient ($I_{OUT} = 250\text{ mA}$)	12
Figure 30.	Flip-Chip4 package outline	13
Figure 31.	Flip-Chip4 recommended footprint	14
Figure 32.	Flip-Chip4 carrier tape	15
Figure 33.	DFN4-1x1 package outline	16
Figure 34.	DFN4-1x1 recommended footprint	17
Figure 35.	DFN4 (1x1x0.38 pitch 4 mm) carrier tape	18
Figure 36.	SOT23-5L package outline	19
Figure 37.	SOT23-5L recommended footprint	20
Figure 38.	Flip-Chip marking composition (marking view)	22

IMPORTANT NOTICE – PLEASE READ CAREFULLY

STMicroelectronics NV and its subsidiaries (“ST”) reserve the right to make changes, corrections, enhancements, modifications, and improvements to ST products and/or to this document at any time without notice. Purchasers should obtain the latest relevant information on ST products before placing orders. ST products are sold pursuant to ST’s terms and conditions of sale in place at the time of order acknowledgement.

Purchasers are solely responsible for the choice, selection, and use of ST products and ST assumes no liability for application assistance or the design of Purchasers’ products.

No license, express or implied, to any intellectual property right is granted by ST herein.

Resale of ST products with provisions different from the information set forth herein shall void any warranty granted by ST for such product.

ST and the ST logo are trademarks of ST. For additional information about ST trademarks, please refer to www.st.com/trademarks. All other product or service names are the property of their respective owners.

Information in this document supersedes and replaces information previously supplied in any prior versions of this document.

© 2019 STMicroelectronics – All rights reserved

单击下面可查看定价，库存，交付和生命周期等信息

[>>STMicroelectronics\(意法半导体\)](#)