

SMD Power Inductor CDPH4D19F

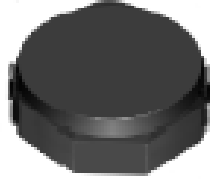

Description

- Ferrite drum core construction.
- Magnetically shielded.
- L × W × H: 5.2 × 5.2 × 2.0mm Max.
- Product weight: 160mg(Ref.)
- Moisture Sensitivity Level: 1
- RoHS compliance.

Dimension - [mm]

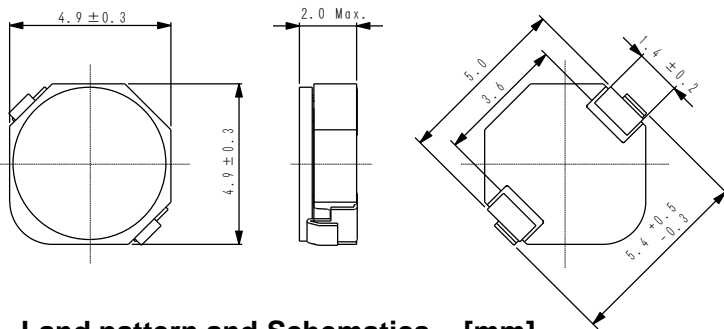

Land pattern and Schematics - [mm]

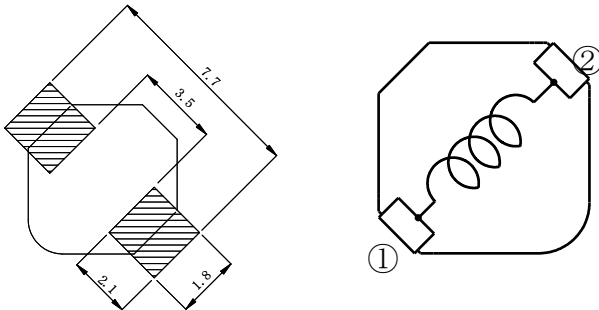

Environmental Data

- Operating temperature range: -40°C ~ +105°C (including coil's self temperature rise)
- Storage temperature range: -40°C ~ +105°C
- Solder reflow temperature: 260 °C peak.

Packaging

- Carrier tape and reel packaging.
- 7.0" diameter reel
- 1000pcs per reel

Applications

- Ideally used in Notebook PC, MP3, Mobile Phone, DSC/DVC, etc as DC-DC Converter inductors.

Electrical Characteristics

Part Name	Stamp	Inductance (μH) [within] ※1	D.C.R. (mΩ) Max. (Typ.) (at 20°C)	Saturation Current (A) ※2	Temperature Rise Current (A) ※3
CDPH4D19FNP-3R3MC	3R3	3.3 ± 20%	33(26)	1.50	3.80
CDPH4D19FNP-4R7MC	4R7	4.7 ± 20%	38(30)	1.15	3.30
CDPH4D19FNP-6R8MC	6R8	6.8 ± 20%	50(40)	1.00	3.02
CDPH4D19FNP-8R0MC	8R0	8.0 ± 20%	56(45)	0.90	2.68
CDPH4D19FNP-100MC	100	10 ± 20%	65(52)	0.80	2.32
CDPH4D19FNP-150MC	150	15 ± 20%	95(75)	0.66	1.88
CDPH4D19FNP-220MC	220	22 ± 20%	135(108)	0.54	1.44
CDPH4D19FNP-330MC	330	33 ± 20%	200(160)	0.43	1.25
CDPH4D19FNP-470MC	470	47 ± 20%	293(234)	0.36	1.03

※1. Inductance measuring condition: at 100kHz.

※2. Saturation current: The value of D.C. current when the inductance decreases to 65% of it's nominal value.

※3. Temperature rise current: The value of D.C. current when the temperature rise is Δt=40°C(Ta=20°C).

SMD Power Inductor CDPH4D19F



Saturation Current & Temperature Rise Graph

— L (20°C) — L (100°C) — ΔT

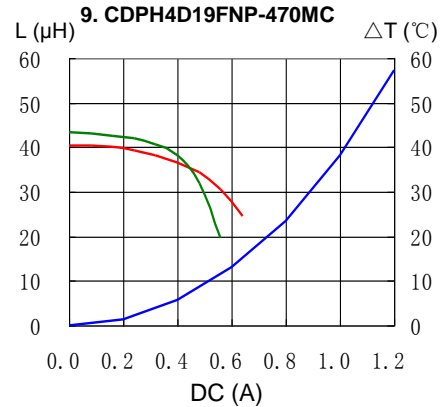
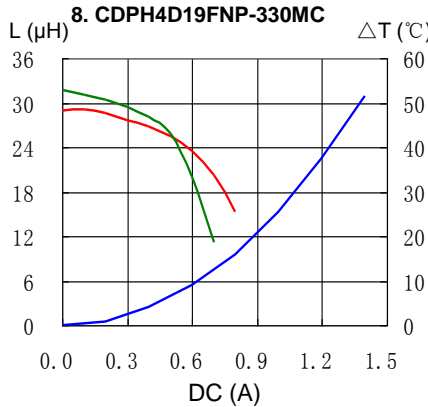
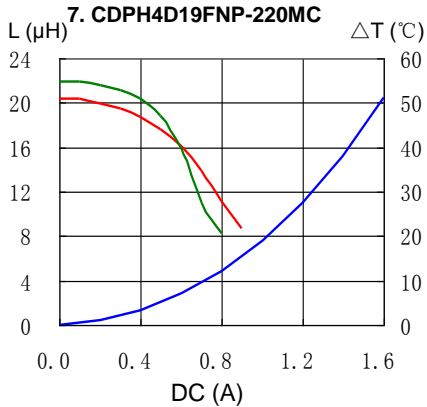
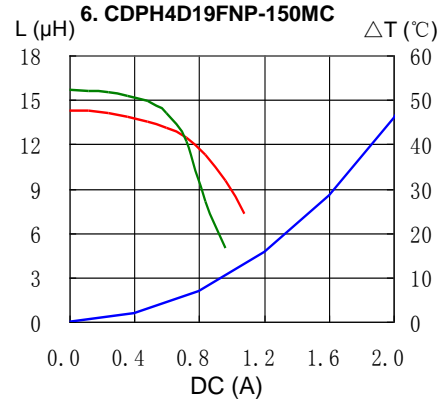
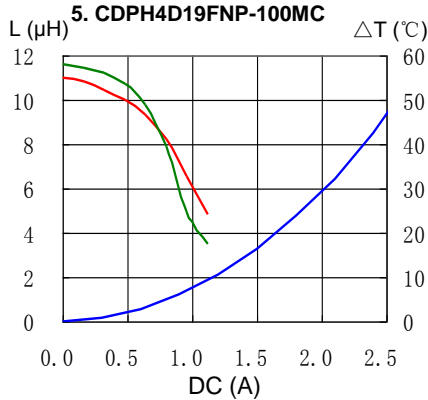
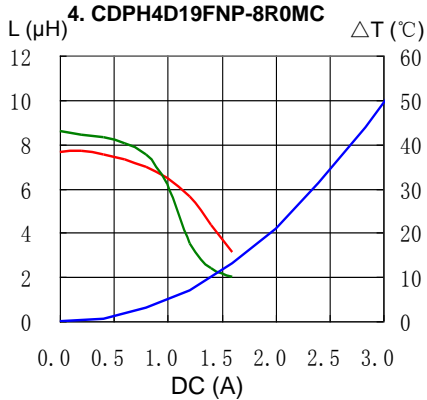
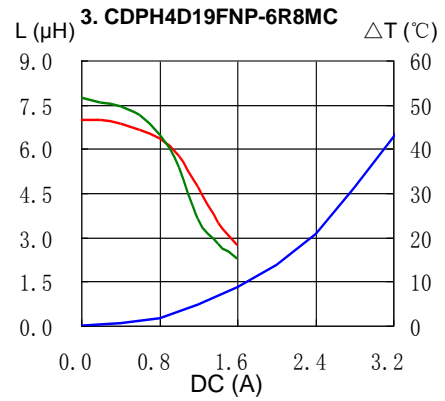
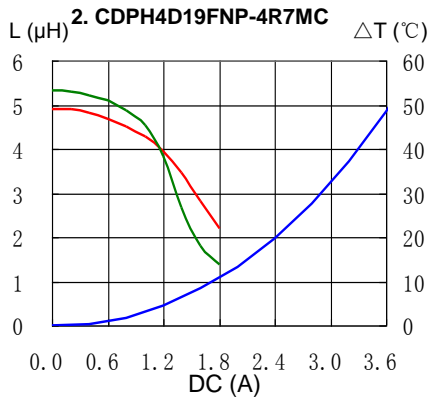
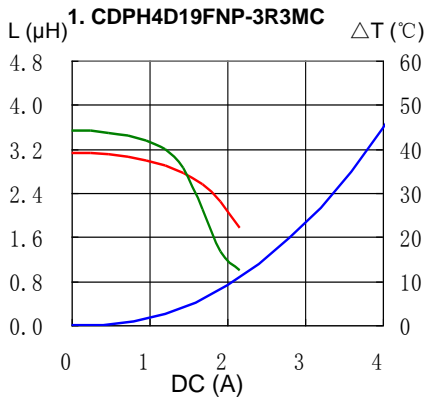

SMD Power Inductor CDPH4D19F



Solder Reflow Condition

Heat Endurance

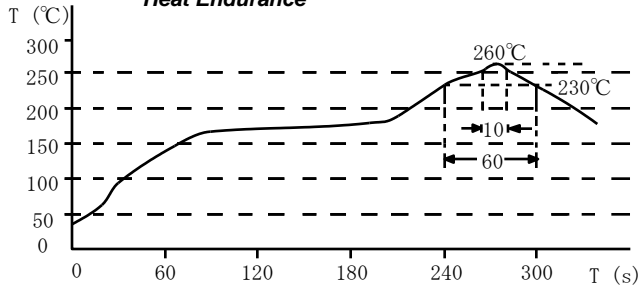

Temperature Chart

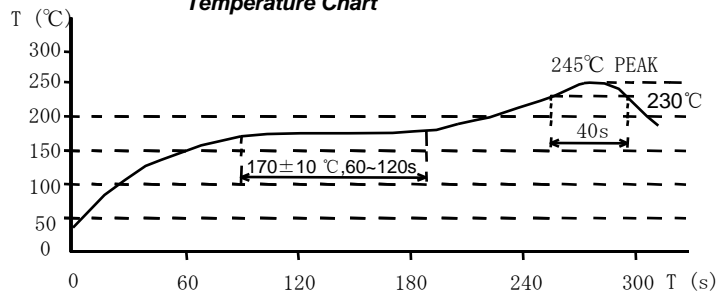

Please refer to the sales offices on our website - <http://www.sumida.com>

Hong Kong

Tel.+852-2880-6781
FAX.+852-2565-9600
sales@hk.sumida.com

Saitama(Japan)

Tel.+81-48-691-7300
FAX.+81-48-691-7340
sales@jp.sumida.com

Chicago

Tel.+1-847-545-6700
FAX. +1-847-545-6720
sales@us.sumida.com

Shanghai

Tel.+86-21-5836-3299
FAX.+86-21-5836-3266
shanghai.sales@cn.sumida.com

Seoul

Tel.+82-2-6237-0777
FAX.+82-2-6237-0778
sales@kr.sumida.com

Obernzell

Tel.+49-8591-937-0
FAX. +49-8591-937-103
contact@eu.sumida.com

Shenzhen

Tel.+86-755-8291-0228
FAX.+86-755-8291-0338
shenzhen.sales@cn.sumida.com

Singapore

Tel.+65-6296-3388
FAX.+65-6841-4426
sales@sg.sumida.com

Neumarkt

Tel.+49-9181-4509-110
FAX. +49-9181-4509-310
infocomp@eu.sumida.com

Taipei

Tel.+886-2-8751-2737
FAX.+886-2-8751-2738
sales@tw.sumida.com

San Jose

Tel.+1-408-321-9660
FAX.+1-408-321-9308
sales@us.sumida.com

单击下面可查看定价，库存，交付和生命周期等信息

[>>Sumida Corporation\(胜美达\)](#)