

SMD Power Inductor CDRH74



Description

- Ferrite drum core construction.
- Magnetically shielded.
- L × W × H: 7.5 × 7.5 × 4.5 mm Max.
- Product weight: 0.78g(Ref.)
- Moisture Sensitivity Level: 1
- RoHS compliance.

Environmental Data

- Operating temperature range: -40°C ~ +100°C (including coil's self temperature rise)
- Storage temperature range: -40°C ~ +100°C
- Solder reflow temperature: 260 °C peak.

Packaging

- Carrier tape and reel packaging
- 12.9" diameter reel
- 1000pcs per reel

Applications

- Ideally used in Notebook PC, LCD TV, DVD, Game machine, STB, Projector etc as DC-DC converter inductors.

Dimension - [mm]

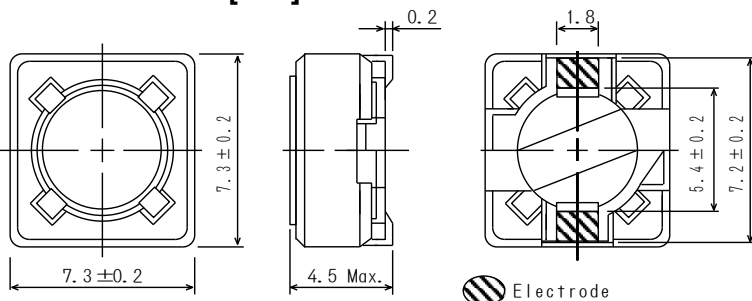

Land pattern and Schematics - [mm]

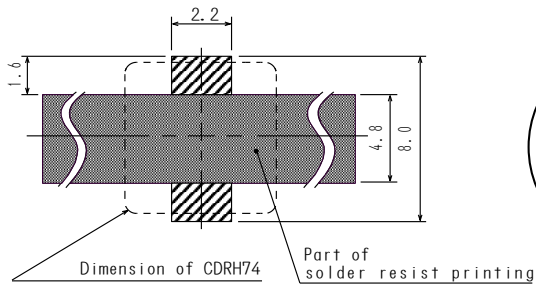

SMD Power Inductor CDRH74



Electrical Characteristics

Part Name	Stamp	Inductance (μH) [within] ※1	D.C.R.(Ω) Max. (Typ.) (at 20°C)	Rated Current (A) ※2
CDRH74NP-100MC-B	100	10 \pm 20%	49m(38m)	1.84
CDRH74NP-120MC-B	120	12 \pm 20%	58m(44m)	1.71
CDRH74NP-150MC-B	150	15 \pm 20%	81m(62m)	1.47
CDRH74NP-180MC-B	180	18 \pm 20%	91m(70m)	1.31
CDRH74NP-220MC-B	220	22 \pm 20%	0.11(77m)	1.23
CDRH74NP-270MC-B	270	27 \pm 20%	0.15(0.12)	1.12
CDRH74NP-330MC-B	330	33 \pm 20%	0.17(0.13)	0.96
CDRH74NP-390MC-B	390	39 \pm 20%	0.23(0.18)	0.91
CDRH74NP-470MC-B	470	47 \pm 20%	0.26(0.20)	0.88
CDRH74NP-560MC-B	560	56 \pm 20%	0.35(0.27)	0.75
CDRH74NP-680MC-B	680	68 \pm 20%	0.38(0.30)	0.69
CDRH74NP-820MC-B	820	82 \pm 20%	0.43(0.33)	0.61
CDRH74NP-101MC-B	101	100 \pm 20%	0.61(0.47)	0.60
CDRH74NP-121MC-B	121	120 \pm 20%	0.66(0.51)	0.52
CDRH74NP-151MC-B	151	150 \pm 20%	0.88(0.68)	0.46
CDRH74NP-181MC-B	181	180 \pm 20%	0.98(0.76)	0.42
CDRH74NP-221MC-B	221	220 \pm 20%	1.17(0.90)	0.36
CDRH74NP-271MC-B	271	270 \pm 20%	1.64(1.32)	0.34
CDRH74NP-331MC-B	331	330 \pm 20%	1.86(1.49)	0.32
CDRH74NP-391MC-B	391	390 \pm 20%	2.85(2.28)	0.29
CDRH74NP-471MC-B	471	470 \pm 20%	3.01(2.41)	0.26
CDRH74NP-561MC-B	561	560 \pm 20%	3.62(2.89)	0.23
CDRH74NP-681MC-B	681	680 \pm 20%	4.63(3.71)	0.22
CDRH74NP-821MC-B	821	820 \pm 20%	5.20(4.16)	0.20
CDRH74NP-102MC-B	102	1.0mH \pm 20%	6.00(4.80)	0.18

※1. Inductance measuring condition: at 1 kHz.

※2. Rated current: The DC current at which the inductance decreases to 75% of its nominal value or when $\Delta t=40^\circ\text{C}$, whichever is lower ($T_a=20^\circ\text{C}$).

SMD Power Inductor CDRH74



Saturation Current & Temperature Rise Graph

— L (20°C) — L (100°C) — ΔT

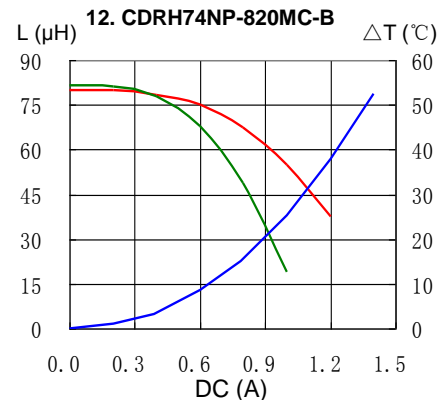
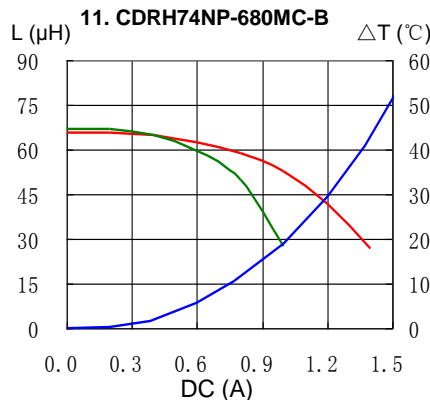
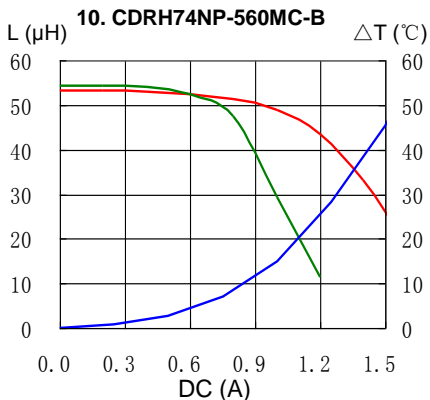
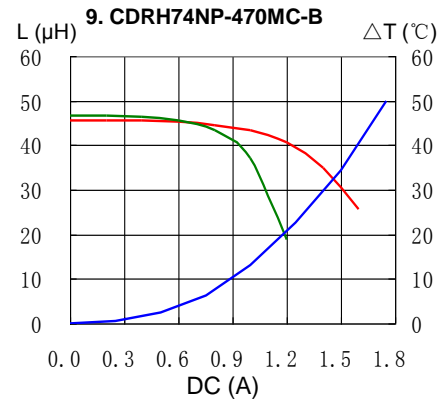
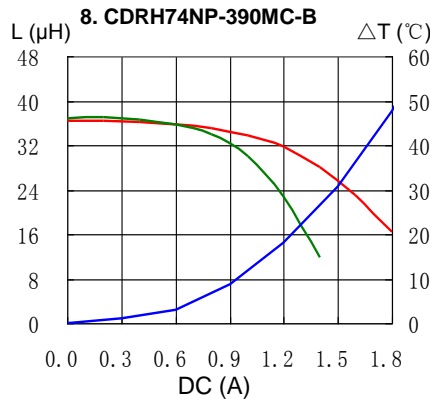
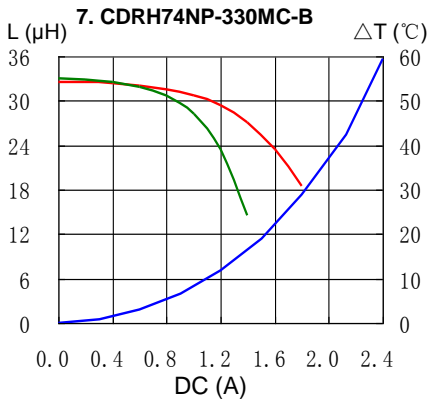
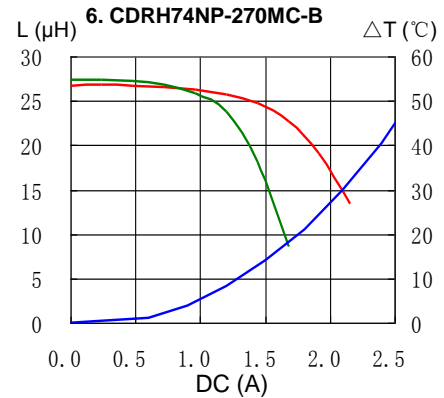
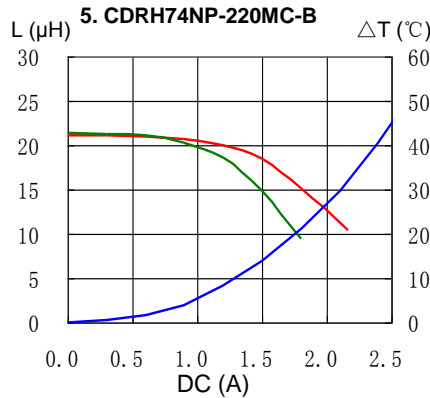
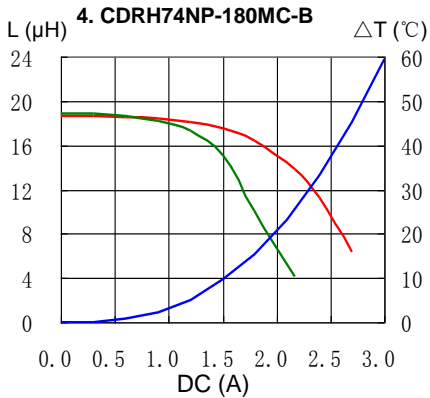
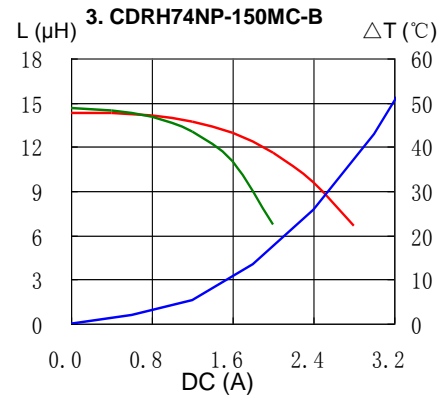
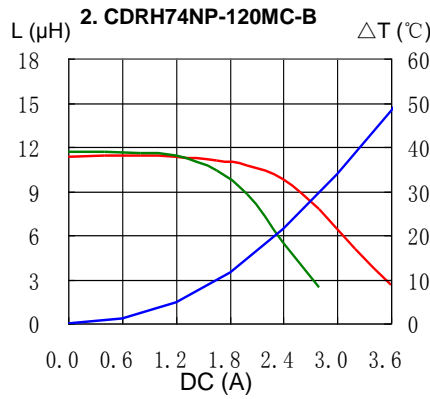
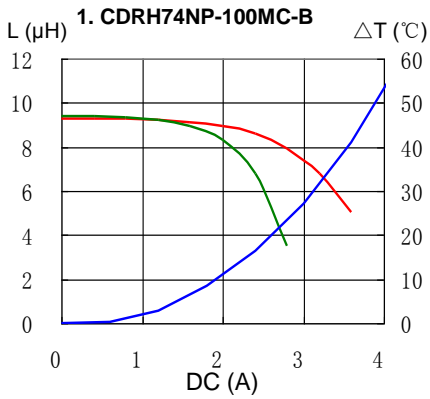

SMD Power Inductor CDRH74



Saturation Current & Temperature Rise Graph

— L (20°C) — L (100°C) — ΔT

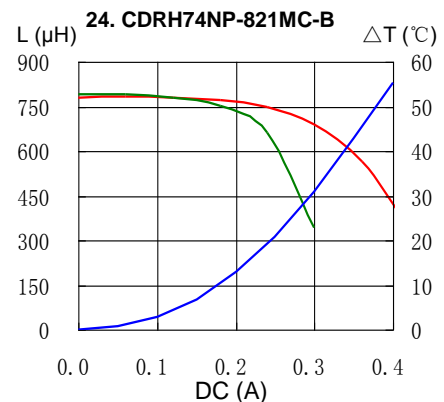
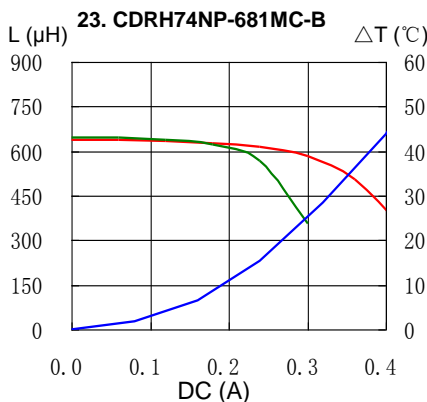
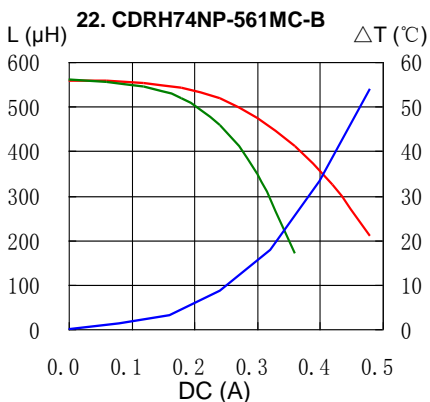
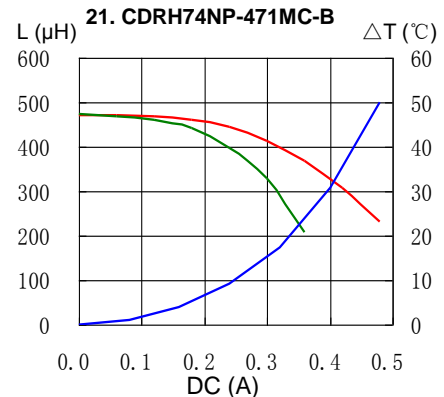
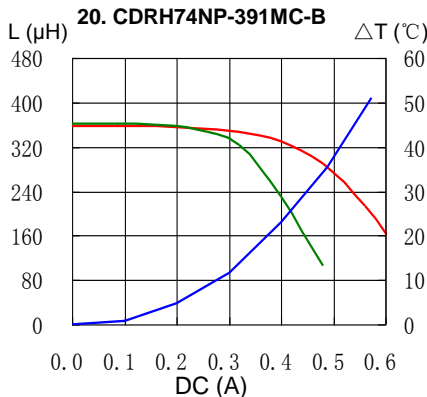
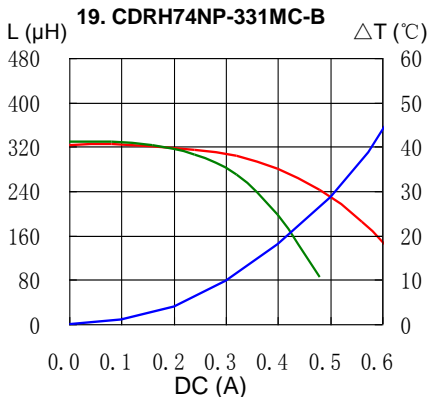
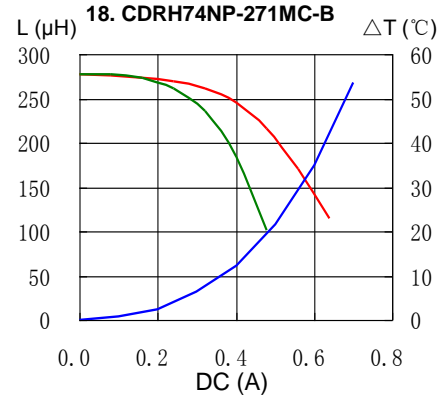
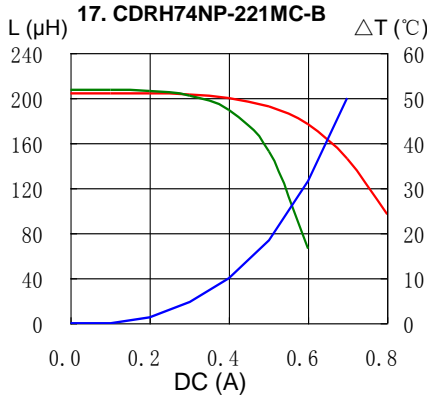
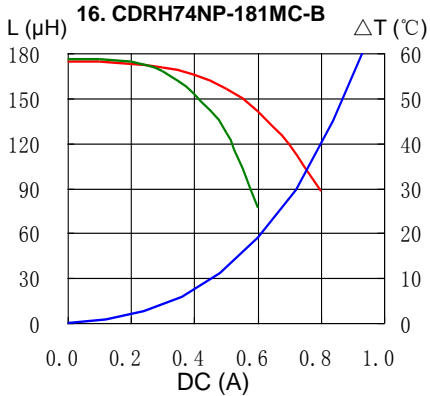
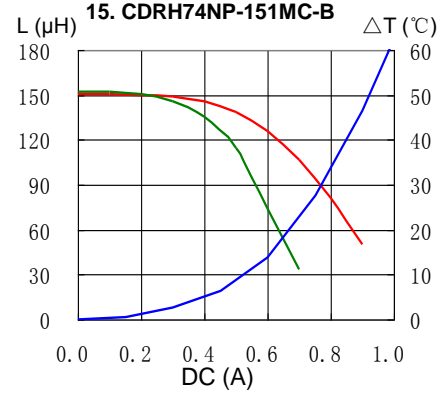
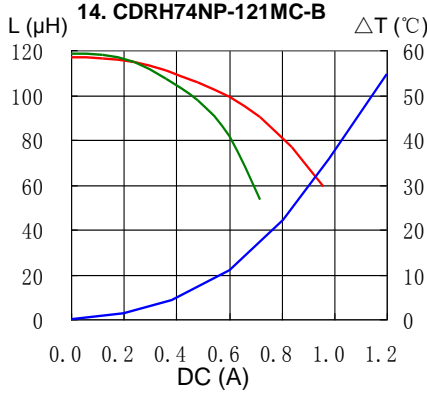
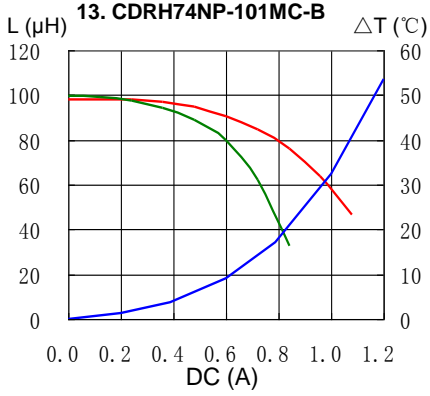

SMD Power Inductor CDRH74

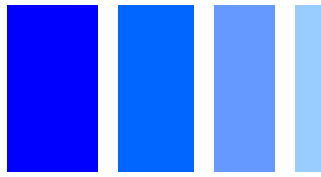

Saturation Current & Temperature Rise Graph

— L (20°C) — L (100°C) — ΔT

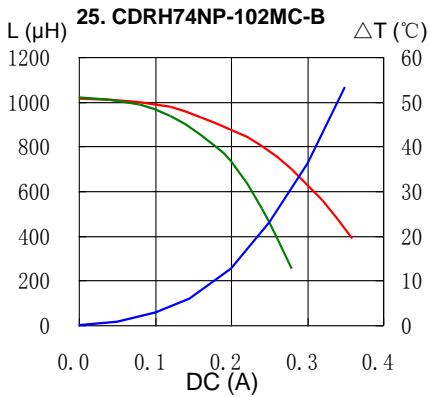

Solder Reflow Condition

Heat Endurance

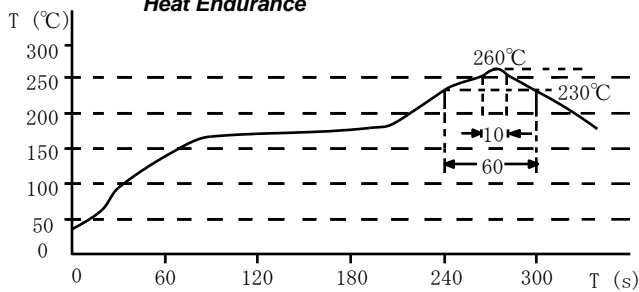

Temperature Chart

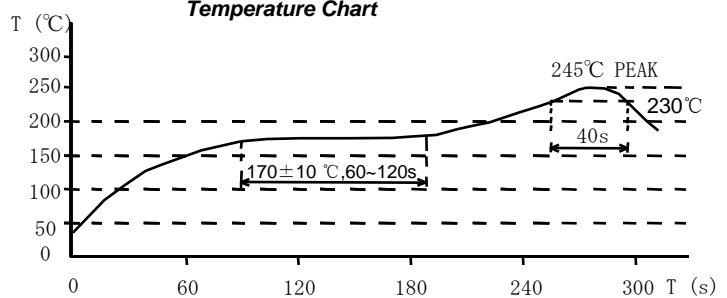

Please refer to the sales offices on our website - <http://www.sumida.com>

Hong Kong

Tel.+852-2880-6781
FAX.+852-2565-9600
sales@hk.sumida.com

Saitama(Japan)

Tel.+81-48-691-7300
FAX.+81-48-691-7340
sales@jp.sumida.com

Chicago

Tel.+1-847-545-6700
FAX. +1-847-545-6720
sales@us.sumida.com

Shanghai

Tel.+86-21-5836-3299
FAX.+86-21-5836-3266
shanghai.sales@cn.sumida.com

Seoul

Tel.+82-2-6237-0777
FAX.+82-2-6237-0778
sales@kr.sumida.com

Obernzell

Tel.+49-8591-937-0
FAX. +49-8591-937-103
contact@eu.sumida.com

Shenzhen

Tel.+86-755-8291-0228
FAX.+86-755-8291-0338
shenzhen.sales@cn.sumida.com

Singapore

Tel.+65-6296-3388
FAX.+65-6841-4426
sales@sg.sumida.com

Neumarkt

Tel.+49-9181-4509-110
FAX. +49-9181-4509-310
infocomp@eu.sumida.com

Taipei

Tel.+886-2-8751-2737
FAX.+886-2-8751-2738
sales@tw.sumida.com

San Jose

Tel.+1-408-321-9660
FAX.+1-408-321-9308
sales@us.sumida.com

单击下面可查看定价，库存，交付和生命周期等信息

[>>Sumida Corporation\(胜美达\)](#)