

SMD Power Inductor CDR7D28MN

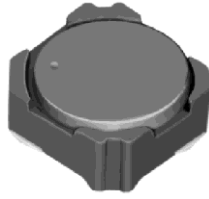

Description

- Ferrite drum core construction.
- Magnetically shielded.
- L × W × H: 7.6 × 7.6 × 3.0 mm Max.
- Product weight: 0.46g(Ref.)
- Moisture Sensitivity Level: 1
- RoHS compliance.

Environmental Data

- Operating temperature range: -40°C ~ +105°C (including coil's self temperature rise)
- Storage temperature range: -40°C ~ +105°C
- Solder reflow temperature: 260 °C peak.

Packaging

- Carrier tape and reel packaging
- 12.9" diameter reel
- 1000pcs per reel

Applications

- Ideally used in LCD driver, DSC/DVC , Notebook PC or the other portable equipment

Dimension - [mm]

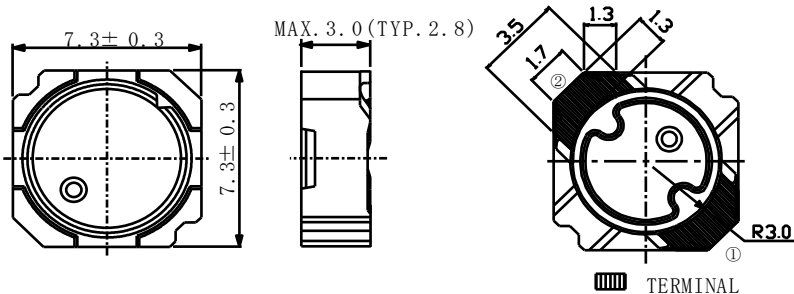

Land pattern and Schematics - [mm]

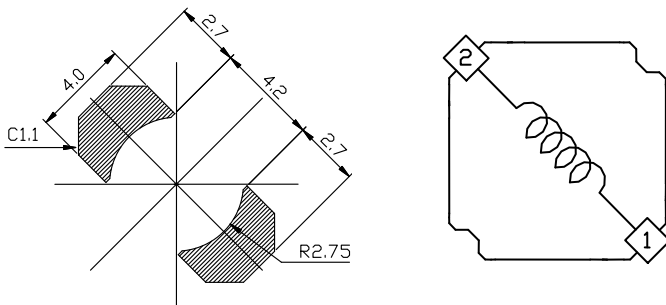

SMD Power Inductor

CDR7D28MN



Electrical Characteristics

Part Name	Stamp	Inductance (μH) [Within] ※1	D.C.R. (m Ω) Max. (Typ.) (at 20°C)	Saturation Current (A) ※2		Temperature rise current: (A) ※3
				(at 20°C)	(at 105°C)	
CDR7D28MNNP-1R2 NC	1R2	1.2 $\mu\text{H} \pm 25\%$	20.5(16.4)	5.90	4.65	4.50
CDR7D28MNNP-2R0 NC	2R0	2.0 $\mu\text{H} \pm 25\%$	23.8(19)	4.55	3.65	3.95
CDR7D28MNNP-2R7 NC	2R7	2.7 $\mu\text{H} \pm 25\%$	27.5(22)	4.10	3.30	3.70
CDR7D28MNNP-3R6 NC	3R6	3.6 $\mu\text{H} \pm 25\%$	32.5(26)	3.55	2.90	3.45
CDR7D28MNNP-4R6 NC	4R6	4.6 $\mu\text{H} \pm 25\%$	37.5(30)	3.30	2.65	3.20
CDR7D28MNNP-6R8 NC	6R8	6.8 $\mu\text{H} \pm 25\%$	46.3(37)	2.90	2.45	2.75
CDR7D28MNNP-8R0 NC	8R0	8.0 $\mu\text{H} \pm 25\%$	50.0(40)	2.60	2.10	2.60
CDR7D28MNNP-100 NC	100	10 $\mu\text{H} \pm 25\%$	53.8(48)	2.40	1.95	2.50
CDR7D28MNNP-150 NC	150	15 $\mu\text{H} \pm 25\%$	81.3(65)	2.10	1.65	2.00
CDR7D28MNNP-220 NC	220	22 $\mu\text{H} \pm 25\%$	120.0(96)	1.65	1.35	1.60
CDR7D28MNNP-330 NC	330	33 $\mu\text{H} \pm 25\%$	196.3(157)	1.35	1.10	1.20
CDR7D28MNNP-470 NC	470	47 $\mu\text{H} \pm 25\%$	275.0(220)	1.05	0.85	1.00
CDR7D28MNNP-680 NC	680	68 $\mu\text{H} \pm 25\%$	425.0(340)	0.90	0.70	0.78
CDR7D28MNNP-101 NC	101	100 $\mu\text{H} \pm 25\%$	655.0(524)	0.75	0.60	0.65
CDR7D28MNNP-151 NC	151	150 $\mu\text{H} \pm 25\%$	950.0(760)	0.60	0.45	0.52
CDR7D28MNNP-221 NC	221	220 $\mu\text{H} \pm 25\%$	1320(1100)	0.50	0.40	0.40
CDR7D28MNNP-331 NC	331	330 $\mu\text{H} \pm 25\%$	2184(1820)	0.35	0.30	0.31
CDR7D28MNNP-471 NC	471	470 $\mu\text{H} \pm 25\%$	2652(2210)	0.30	0.25	0.28

※1. Inductance measuring condition: at 100kHz.

※2. Saturation current: The value of D.C. current when the inductance decreases to 65% of its nominal value.

※3. Temperature rise current: The value of D.C. current when the temperature rise is $\Delta t = 40^\circ\text{C}$ ($T_a = 20^\circ\text{C}$).

SMD Power Inductor CDR7D28MN



Saturation Current & Temperature Rise Graph

— L (20°C) — L (100°C) — ΔT

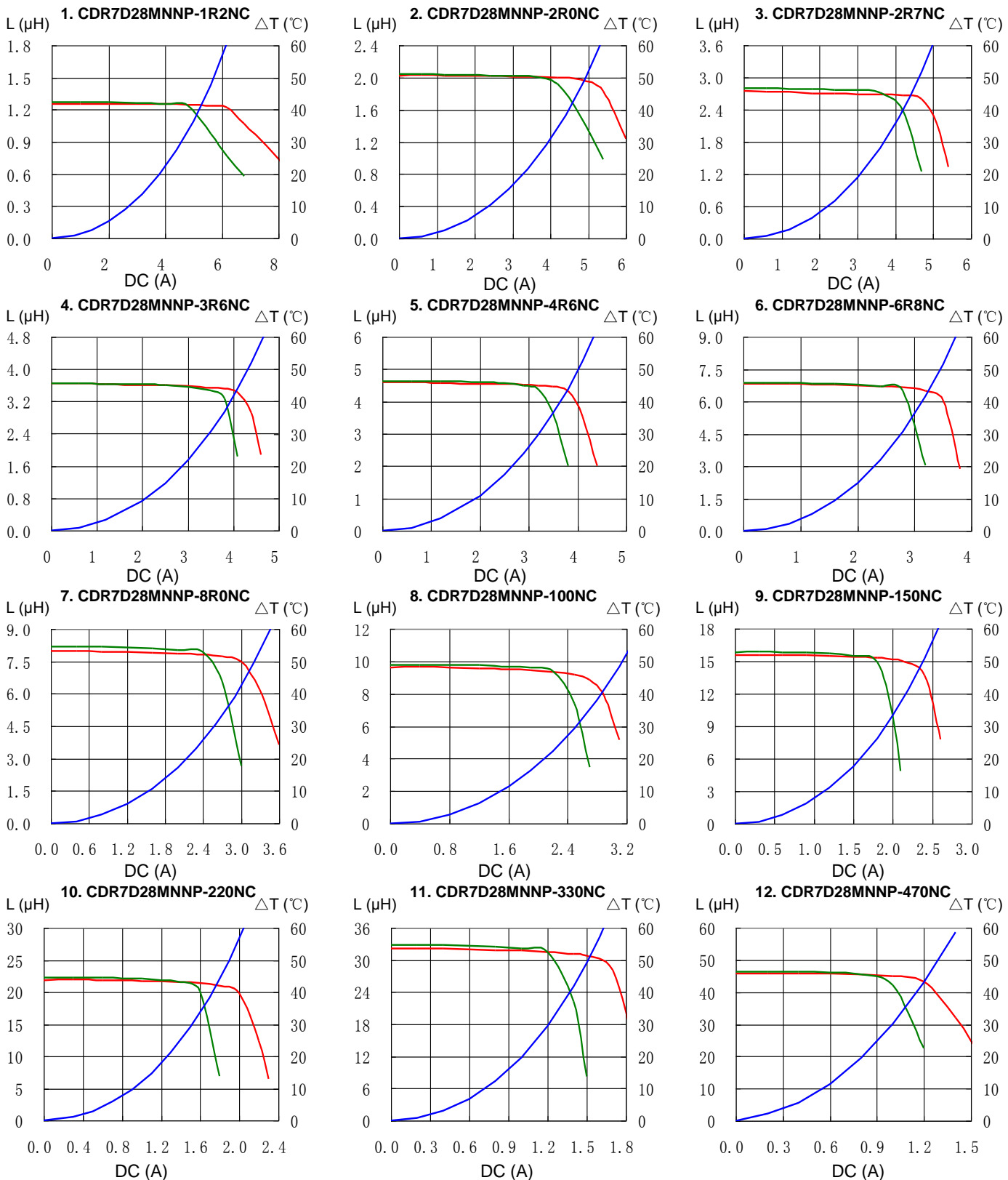

SMD Power Inductor CDR7D28MN



Saturation Current & Temperature Rise Graph

— L (20°C) — L (100°C) — ΔT

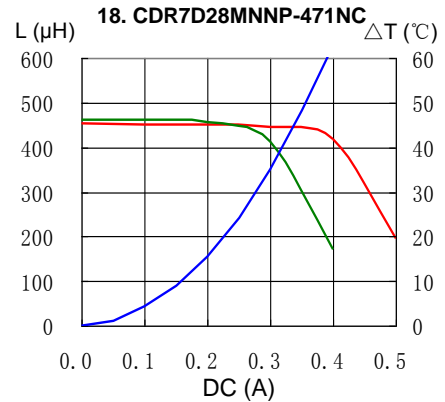
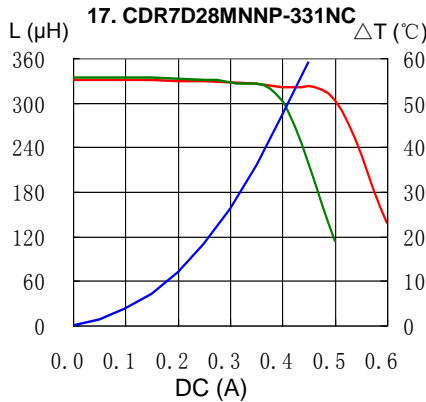
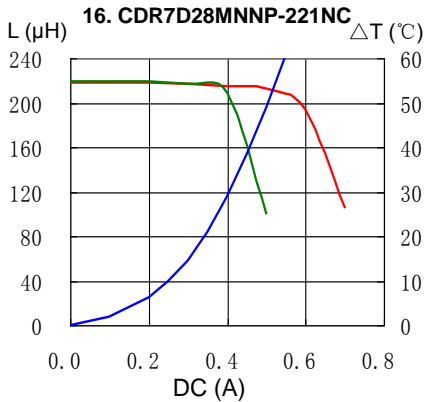
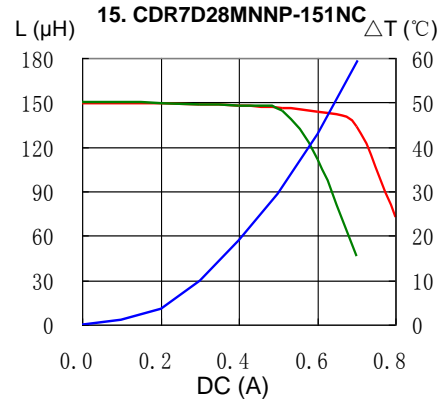
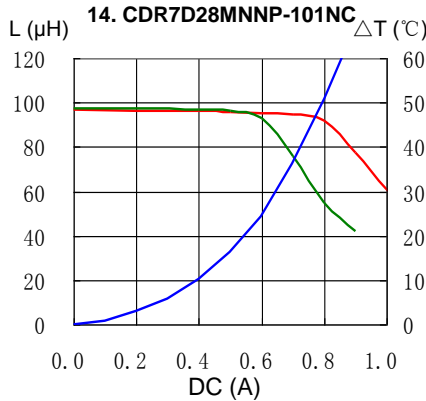
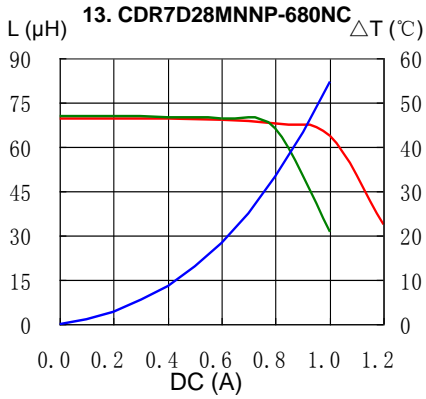

Solder Reflow Condition

Heat Endurance

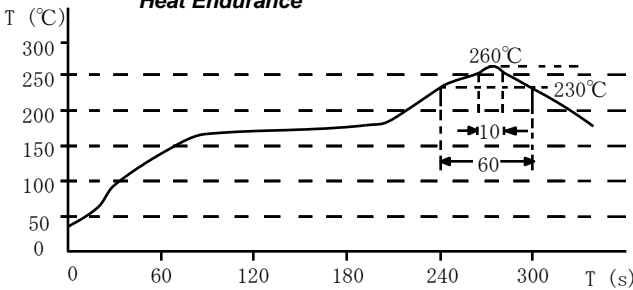

Temperature Chart

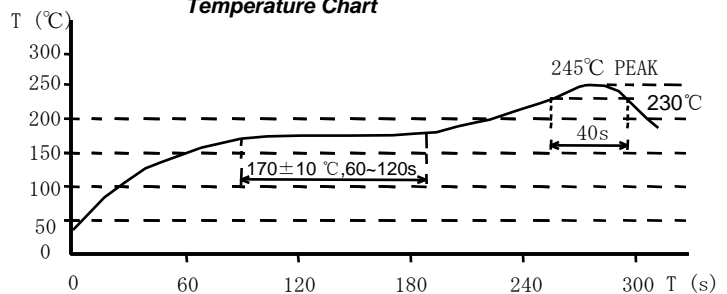

Please refer to the sales offices on our website - <http://www.sumida.com>

Hong Kong

Tel.+852-2880-6781
FAX.+852-2565-9600
sales@hk.sumida.com

Saitama(Japan)

Tel.+81-48-691-7300
FAX.+81-48-691-7340
sales@jp.sumida.com

Chicago

Tel.+1-847-545-6700
FAX. +1-847-545-6720
sales@us.sumida.com

Shanghai

Tel.+86-21-5836-3299
FAX.+86-21-5836-3266
shanghai.sales@cn.sumida.com

Seoul

Tel.+82-2-6237-0777
FAX.+82-2-6237-0778
sales@kr.sumida.com

Obernzell

Tel.+49-8591-937-0
FAX. +49-8591-937-103
contact@eu.sumida.com

Shenzhen

Tel.+86-755-8291-0228
FAX.+86-755-8291-0338
shenzhen.sales@cn.sumida.com

Singapore

Tel.+65-6296-3388
FAX.+65-6841-4426
sales@sg.sumida.com

Neumarkt

Tel.+49-9181-4509-110
FAX. +49-9181-4509-310
infocomp@eu.sumida.com

Taipei

Tel.+886-2-8751-2737
FAX.+886-2-8751-2738
sales@tw.sumida.com

San Jose

Tel.+1-408-321-9660
FAX.+1-408-321-9308
sales@us.sumida.com

单击下面可查看定价，库存，交付和生命周期等信息

[>>Sumida Corporation\(胜美达\)](#)