

# SMD Power Inductor CDRH3D11/HP

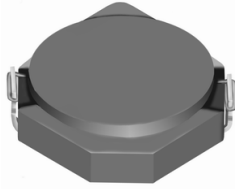

## Description

- Ferrite drum core construction.
- Magnetically shielded.
- L × W × H: 4.0 × 4.0 × 1.2 mm Max.
- Product weight: 55mg(Ref.)
- Moisture Sensitivity Level: 1
- RoHS compliance.

## Environmental Data

- Operating temperature range: -40°C ~ +105°C (including coil's self temperature rise)
- Storage temperature range: -40°C ~ +105°C
- Solder reflow temperature: 260 °C peak.

## Packaging

- Carrier tape and reel packaging
- 7.0" diameter reel
- 1000pcs per reel

## Applications

- Ideally used in Mobile phone, PDA, MP3, DSC/DVC, Portable DVD, etc as DC-DC converter inductors.

## Dimension - [mm]

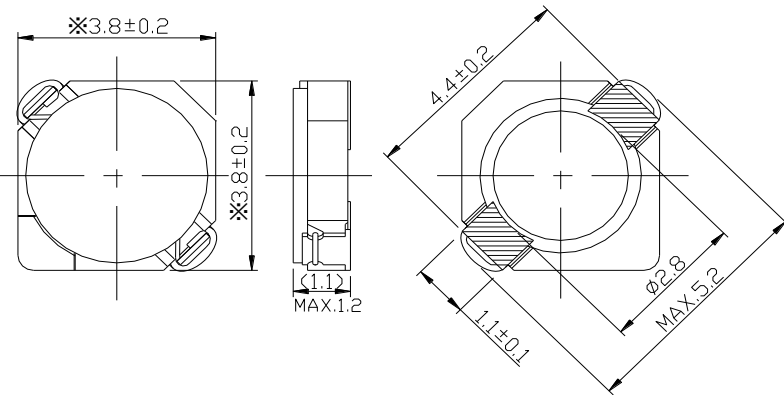

## Land pattern and Schematics - [mm]

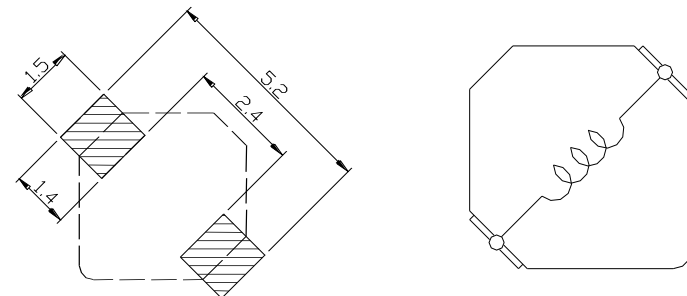

# SMD Power Inductor CDRH3D11/HP



## Electrical Characteristics

Part Name	Stamp	Inductance ( $\mu\text{H}$ ) [ within ] ※1	D.C.R. (m $\Omega$ ) Max. (Typ.) (at 20°C)	Saturation Current (A) ※2		Temperature Rise Current (A) ※3
				at 20°C	at 105°C	
CDRH3D11HPNP-0R6NC	A	0.6 $\pm$ 25%	59(45)	2.90	2.10	1.80
CDRH3D11HPNP-1R2NC	B	1.2 $\pm$ 25%	82(63)	2.00	1.50	1.70
CDRH3D11HPNP-1R5NC	C	1.5 $\pm$ 25%	104(80)	1.85	1.40	1.45
CDRH3D11HPNP-2R2NC	D	2.2 $\pm$ 25%	143(110)	1.60	1.20	1.15
CDRH3D11HPNP-3R3NC	E	3.3 $\pm$ 25%	182(140)	1.25	0.90	0.95
CDRH3D11HPNP-4R7NC	F	4.7 $\pm$ 25%	234(180)	1.00	0.70	0.90
CDRH3D11HPNP-6R8NC	G	6.8 $\pm$ 25%	377(290)	0.85	0.63	0.70
CDRH3D11HPNP-100NC	H	10.0 $\pm$ 25%	413(330)	0.80	0.60	0.60
CDRH3D11HPNP-120NC	I	12.0 $\pm$ 25%	585(470)	0.64	0.45	0.48
CDRH3D11HPNP-150NC	J	15.0 $\pm$ 25%	653(520)	0.58	0.42	0.45
CDRH3D11HPNP-180NC	K	18.0 $\pm$ 25%	888(710)	0.52	0.40	0.40
CDRH3D11HPNP-220NC	L	22.0 $\pm$ 25%	1012(810)	0.45	0.35	0.33

※1. Inductance measuring condition: at 100kHz.

※2. Saturation current: The value of D.C. current when the inductance decreases to 65% of it's nominal value.

※3. Temperature rise current: The value of D.C. current when the temperature rise is  $\Delta t=40^\circ\text{C}$  ( $T_a=20^\circ\text{C}$ ).

# SMD Power Inductor CDRH3D11/HP



## Saturation Current & Temperature Rise Graph

— L (20°C) — L (105°C) —  $\Delta T$

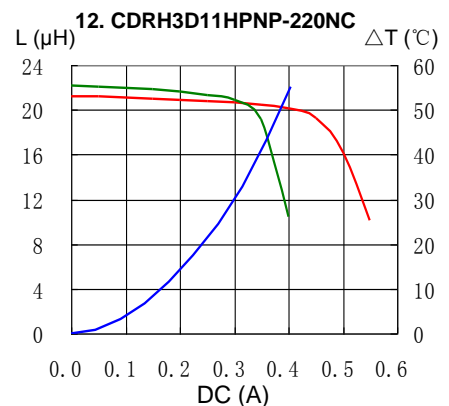
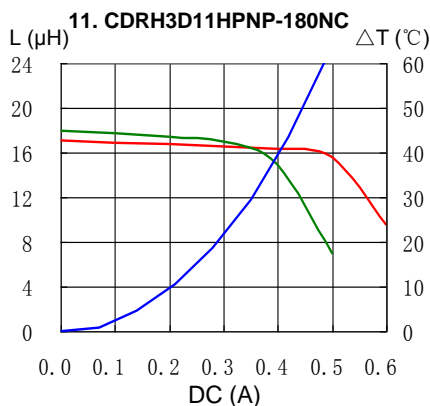
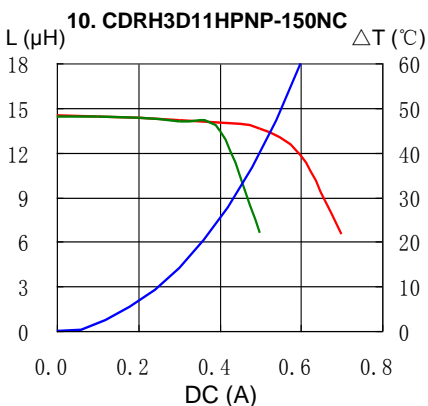
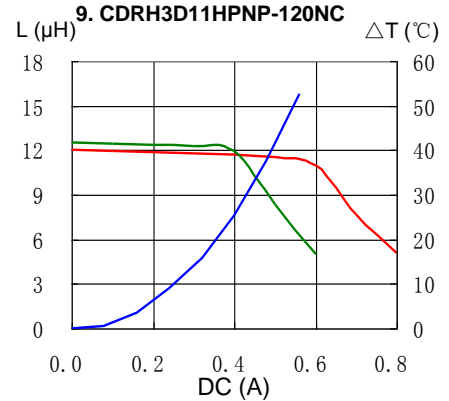
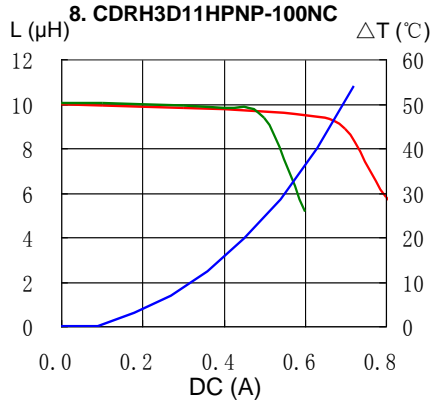
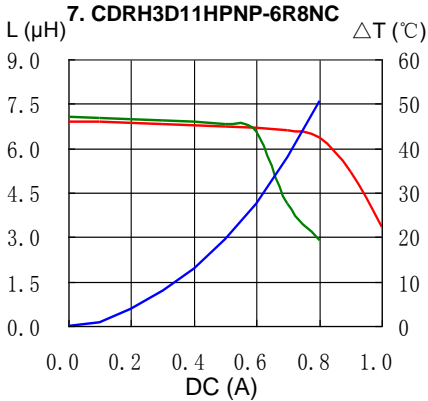
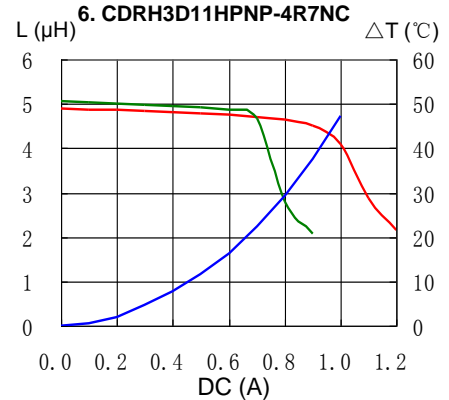
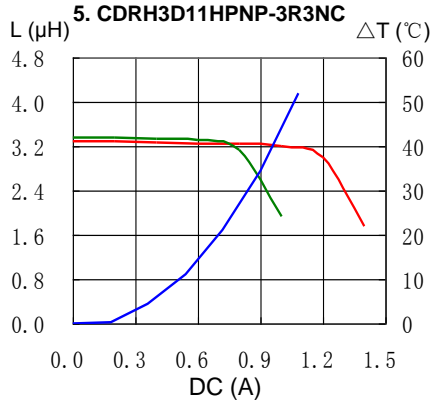
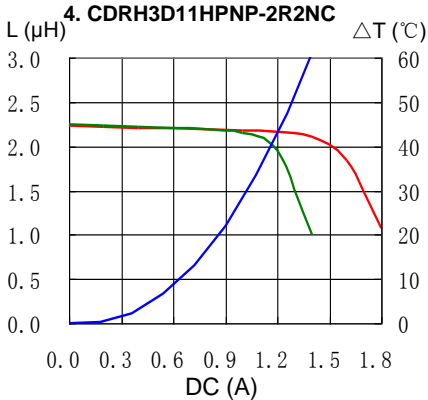
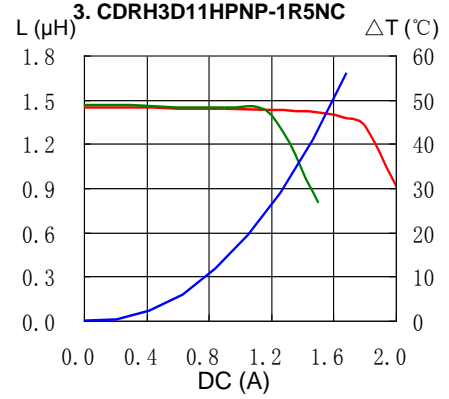
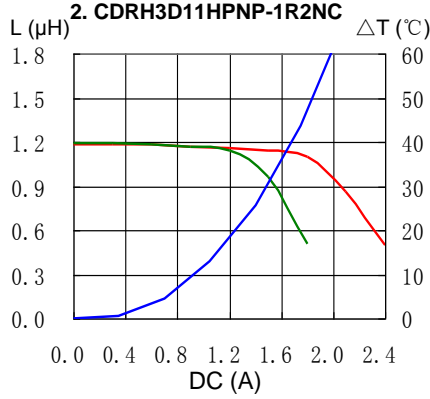
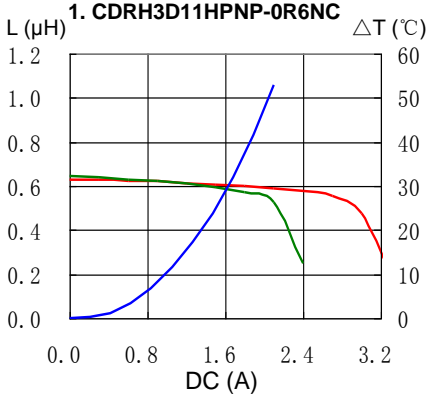

# SMD Power Inductor CDRH3D11/HP



## Solder Reflow Condition

Heat Endurance

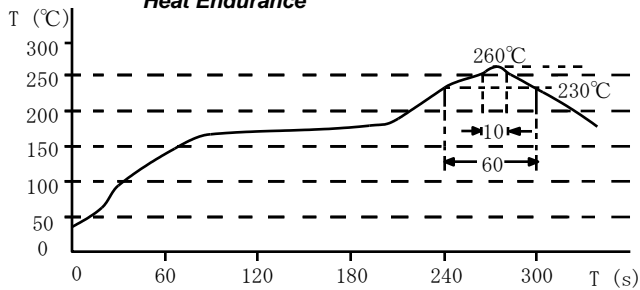

Temperature Chart

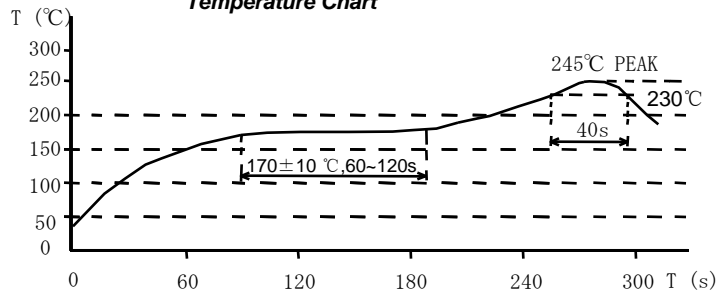

Please refer to the sales offices on our website - <http://www.sumida.com>

### Hong Kong

Tel.+852-2880-6781  
FAX.+852-2565-9600  
[sales@hk.sumida.com](mailto:sales@hk.sumida.com)

### Saitama(Japan)

Tel.+81-48-691-7300  
FAX.+81-48-691-7340  
[sales@jp.sumida.com](mailto:sales@jp.sumida.com)

### Chicago

Tel.+1-847-545-6700  
FAX. +1-847-545-6720  
[sales@us.sumida.com](mailto:sales@us.sumida.com)

### Shanghai

Tel.+86-21-5836-3299  
FAX.+86-21-5836-3266  
[shanghai.sales@cn.sumida.com](mailto:shanghai.sales@cn.sumida.com)

### Seoul

Tel.+82-2-6237-0777  
FAX.+82-2-6237-0778  
[sales@kr.sumida.com](mailto:sales@kr.sumida.com)

### Obernzell

Tel.+49-8591-937-0  
FAX. +49-8591-937-103  
[contact@eu.sumida.com](mailto:contact@eu.sumida.com)

### Shenzhen

Tel.+86-755-8291-0228  
FAX.+86-755-8291-0338  
[shenzhen.sales@cn.sumida.com](mailto:shenzhen.sales@cn.sumida.com)

### Singapore

Tel.+65-6296-3388  
FAX.+65-6841-4426  
[sales@sg.sumida.com](mailto:sales@sg.sumida.com)

### Neumarkt

Tel.+49-9181-4509-110  
FAX. +49-9181-4509-310  
[infocomp@eu.sumida.com](mailto:infocomp@eu.sumida.com)

### Taipei

Tel.+886-2-8751-2737  
FAX.+886-2-8751-2738  
[sales@tw.sumida.com](mailto:sales@tw.sumida.com)

### San Jose

Tel.+1-408-321-9660  
FAX.+1-408-321-9308  
[sales@us.sumida.com](mailto:sales@us.sumida.com)

单击下面可查看定价，库存，交付和生命周期等信息

[>>Sumida Corporation\(胜美达\)](#)