

DATA SHEET

SUNGMUN CODE : MSSR-16H1

DESCRIPTION : MINI ROTARY DIP SWITCH

SUNGMUN ELECTRONICS CO., LTD.

Address 301-302, Bucheon Technopark 345, Seokcheon-ro, Ojeong-gu

Bucheon-si, Gyeonggi-do, Korea

TEL. +82-32-328-1941~4

FAX +82-32-328-1945

E-mail sungmun@sungmun.co.kr

Website www.sungmun.com



SUNGMUN
ELECTRONICS

MRK. 	DATE	REVISION	SIGN
--	------	----------	------

SPECIFICATION

1. Rating : 100mA, DC 42V (Switching)
400mA, DC 42V (None-Switching)
2. Contact Resistance : 80mΩ Max
3. Insulation Resistance : 100MΩ Min
4. Operating Force : 120±30gf Max
5. Life cycle : 25,000 steps
6. Sealing : IP67 (Dust & Water proof)
7. Packing : 65pcs Tube

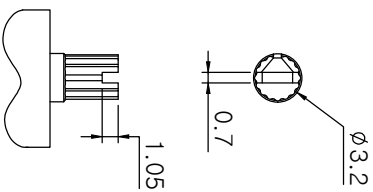

ACTUATOR

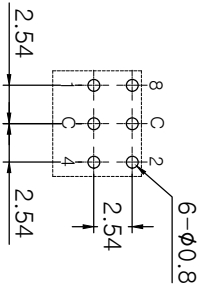
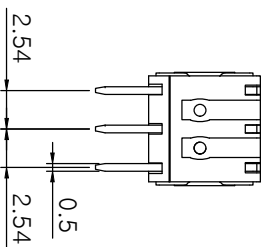
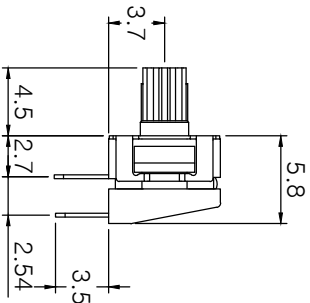
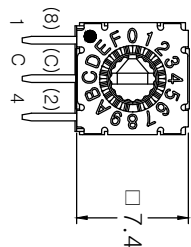
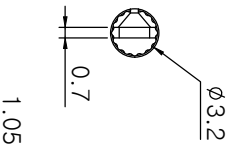

P.C.B. DIMENSION (Top View)

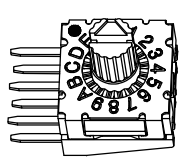
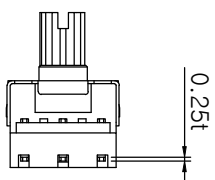

Real Coded								
	C	1	2	4	8			
0	●					0		
1	●	●				1		
2	●		●			2		
3	●			●		3		
4	●				●	4		
5	●	●				5		
6	●		●			6		
7	●			●		7		
8	●				●	8		
9	●	●				9		
10	●		●			A		
11	●			●		B		
12	●				●	C		
13	●	●				D		
14	●		●			E		
15	●			●		F		

DRAW/DESIGNED	CHECKED	APPROVED	UNIT	G.TOL	TITLE	MODEL NO.	REV.
Y.S KIM	BS KANG	K.I LEE	mm	±0.3	ROTARY DIP SWITCH	MSSR-16H1	03
2021-08-20	2021-08-20	2021-08-23	SCALE	2:1		MSSR-16H1-03	
 SUNGUM ELECTRONICS CO.,LTD			SIZE	A4	DRAW NO.		

1. Style:

This specification describes "7.4X7.4 size of Mini Rotary Dip Switch" which is M series.

1.1 Operating / Storage Temperature Range : -60°C ~ +125°C

2. Rating:

2.1 None-Switching : 400 mA, DC 42V

2.2 Switching : 100 mA, DC 42V

3. Type of Actuation : Rotating

4. Electrical Characteristics

ITEM	DESCRIPTION	TEST CONDITIONS	REQUIREMENTS
4-1	Visual Examination	By visual examination check without any out pressure & testing.	There shall be no defects that affect the serviceability of the product.
4-2	Contact Resistance	① To be measured between the two terminals associated with each switch pole. ② Measurements shall be made with a 1kHz shall current contact resistance meter.	80mΩ max. (initial)
4-3	Insulation Resistance	250V DC	100 MΩ min.
4-4	Dielectric withstanding Voltage	250V AC(50Hz or 60Hz)shall be applied between all the adjacent terminal and between the terminal and the frame for 1 minute.	There shall be no breakdown or flashover.

5. Mechanical Characteristics

ITEM	DESCRIPTION	TEST CONDITIONS	REQUIREMENTS
5-1	Operation Force	Operating direction shall be clockwise or counter clockwise direction	120gf•cm ±30 max
5-2	Operation Life	Measurements shall be made following the test set forth below: 1)100mA, 42V DC resistive load 2)Rate of operation: 15~20 cycles/ minute 3)Step of operation: 25,000 steps	1)As shown in item 4-3,4-4 2)Contact Resistance: 200mΩ max 3)Final-after test

6. Environmental Characteristics

ITEM	DESCRIPTION	TEST CONDITIONS	REQUIREMENTS
6-1	Resistance Low Temperature	Following the test set forth below the sample shall be left in normal temperature and humidity conditions for an hour before measurements are made: 1)Temperature: -60°C ±3°C 2)Time: 96 hours	1)As shown in item 4-3, 4-4, 5-1 2)Contact Resistance: 200mΩ max
6-2	Resistance High Temperature	Following the test set forth below the sample shall be left in normal temperature and humidity conditions for an hour before measurements are made: 1)Temperature: 125°C ±2°C 2)Time: 96 hours	1)As shown in item 4-3, 4-4, 5-1 2)Contact Resistance: 200mΩ max
6-3	Resistance Humidity	Following the test set forth below the sample shall be left in normal temperature and humidity conditions for an hour before measurements are made: 1)Temperature: 40°C ±2°C 2)Relative humidity: 90~95% 3)Time: 96 hours	1)As shown in item 4-4, 5-1 2)Contact Resistance: 200mΩ max 3)Insulation Resistance: 10 MΩ min

7. This item is "RoHS" Compliant

8. Manual Soldering : Max 350°C, 3 sec.

9. Wave Soldering : Max 280°C, 5 sec.

10. Reflow Soldering Conditions: (SMD type only)

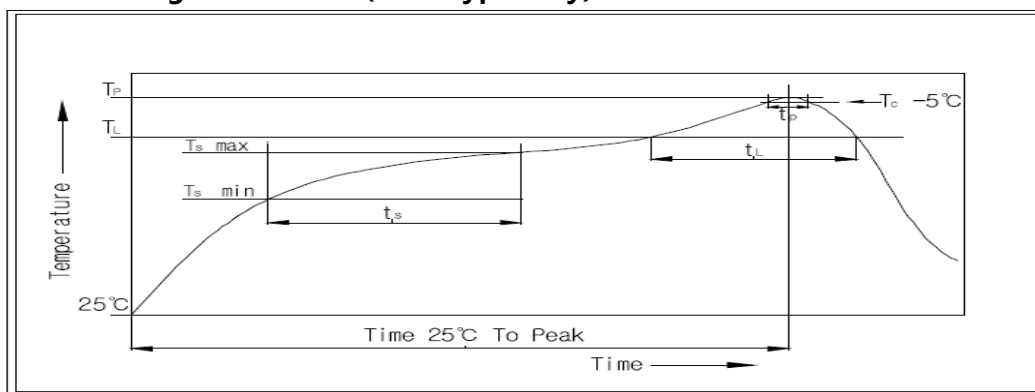

10-1 Condition for Soldering

Profile Feature	Pb-Free Assembly
Average Ramp-UP Rate($T_{s \text{ max}}$ to T_p)	3°C/second max
Preheat	
- Temperature Min($T_{s \text{ min}}$)	150°C
- Temperature Max($T_{s \text{ max}}$)	200°C
- Time ($t_{s \text{ min}}$ to $t_{s \text{ max}}$)	60-180seconds
Time maintained above:	
- Temperature (T_L)	217°C
- Time (t_L)	60-150seconds
Peak/Classification Temperature(T_p)	260°C +0°C/ -5°C
Time within 5°C of actual Peak Temperature(T_p)	Min 30 seconds
Ramp-Down Rate	6°C/sec max
Time 25°C to Peak Temperature	8 minutes max

单击下面可查看定价，库存，交付和生命周期等信息

[>>SUNGMUN\(韩国星纹电子\)](#)