

# Wire Wound Chip Ceramic Inductor – SDWL – C Series

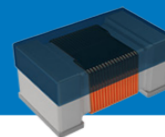

Operating temp. : -40°C ~+125°C

## FEATURES

- ◆ Small chip suitable for surface mounting
- ◆ High Q value and high self-resonant frequency with ceramic material
- ◆ Tight inductance tolerance and high reliability

## APPLICATIONS

- ◆ High frequency circuit in telecommunication and other equipments
- ◆ Mobile phones and other electronic devices
- ◆ Bluetooth, W-LAN, Broadband network

## PRODUCT IDENTIFICATION

<b>1</b>	<b>2</b>	<b>3</b>	<b>4</b>	<b>5</b>	<b>6</b>	<b>7</b>	<b>8</b>
<b>SDWL</b>	<b>2012</b>	<b>C</b>	<b>10N</b>	<b>J</b>	<b>S</b>	<b>T</b>	<b>F</b>

1 Type	
SDWL	Wire Wound Chip Inductor

2 External Dimensions	
2012 [0805]	2.25×1.73
2520 [1008]	2.92×2.79
3216 [1206]	3.56×2.16
3225 [1210]	3.65×2.95
4532 [1812]	4.95×3.81

3 Material Code	
C	Ceramic

4 Nominal Inductance	
Example	Nominal Value
10N	10nH
R10	100nH
1R0	1.0μH

5 Inductance Tolerance	
G	±2%
J	±5%
K	±10%

6 Feature Type	
S	Sn Plating Five-faces Coating

7 Packing	
T	Tape & Reel

8 Hazardous SubstanceFree Products	
F	

## SHAPE AND DIMENSIONS

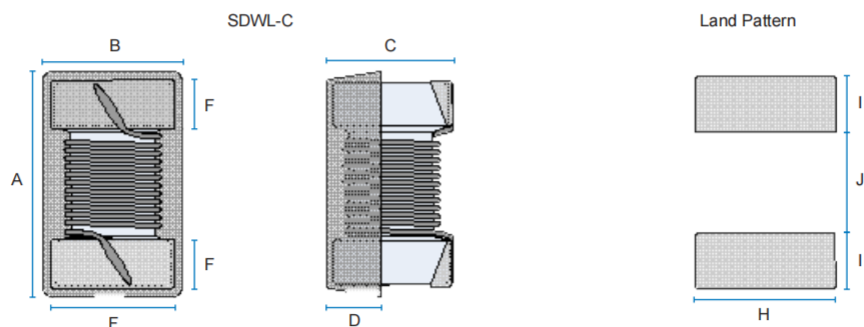

Series	A Max.	B Max.	C Max.	D Typ.	E Typ.	F Typ.	H Typ.	I Typ.	J Typ.
SDWL2012C	2.25	1.73	1.50	0.51	1.27	0.50	1.78	1.02	0.76
SDWL2520C	2.92	2.79	2.29	0.51	2.10	0.50	2.54	1.02	1.27
SDWL3216C	3.56	2.16	1.52	0.51	1.60	0.50	1.93	1.02	1.78
SDWL3225C	3.65	2.95	2.70	0.51	2.10	0.50	3.02	1.02	1.78
SDWL4532C	4.95	3.81	3.43	1.78	2.90	0.58	3.05	1.14	3.00

Unit: mm

## SPECIFICATIONS SDWL2012C TYPE

Part Number	Inductance	Tolerance	Min. Quality Factor	L/Q Test Freq.	Min.Self-resonant Frequency	Max. DC Resistance	Max. Rated Current
Units	nH	-	-	MHz	MHz	$\Omega$	mA
Symbol	L	-	Q	Freq.	S.R.F	DCR	Ir
SDWL2012C2N2 □ STF	2.2	J,K	40	250/1500	>6000	0.1	600
SDWL2012C2N5 □ STF	2.5	J,K	25	100/250	>6000	0.05	600
SDWL2012C2N7 □ STF	2.7	J,K	40	250/1500	>6000	0.05	600
SDWL2012C2N8 □ STF	2.8	J,K	35	250/250	6000	0.06	600
SDWL2012C3N0 □ STF	3.0	J,K	25	250/1500	6000	0.2	600
SDWL2012C3N3 □ STF	3.3	J,K	25	250/1500	>6000	0.2	600
SDWL2012C3N6 □ STF	3.6	J,K	25	250/1500	6000	0.2	400
SDWL2012C3N9 □ STF	3.9	J,K	30	250/1500	6000	0.2	400
SDWL2012C4N7 □ STF	4.7	J,K	60	250/1500	>6000	0.04	600
SDWL2012C5N0 □ STF	5.0	J,K	40	250/250	5500	0.1	600
SDWL2012C5N1 □ STF	5.1	J,K	35	250/1000	5500	0.1	600
SDWL2012C5N6 □ STF	5.6	J,K	43	250/1000	5500	0.1	600
SDWL2012C6N0 □ STF	6.0	J,K	48	250/1000	5000	0.11	600
SDWL2012C6N2 □ STF	6.2	J,K	50	250/1000	5000	0.05	600
SDWL2012C6N8 □ STF	6.8	J,K	40	250/1000	5000	0.11	600
SDWL2012C7N5 □ STF	7.5	J,K	40	250/1000	4600	0.14	600
SDWL2012C8N2 □ STF	8.2	J,K	40	250/1000	4600	0.19	600
SDWL2012C8N5 □ STF	8.5	J,K	38	250/1000	5000	0.27	600
SDWL2012C9N1 □ STF	9.1	J,K	38	250/1000	5000	0.16	600
SDWL2012C10N □ STF	10	G,J,K	44	250/1000	4500	0.14	600
SDWL2012C11N □ STF	11	G,J,K	40	250/500	4000	0.15	600
SDWL2012C12N □ STF	12	G,J,K	40	250/500	4000	0.15	600
SDWL2012C13N □ STF	13	G,J,K	40	250/500	3500	0.17	600
SDWL2012C14N □ STF	14	G,J,K	40	250/500	3400	0.17	600
SDWL2012C15N □ STF	15	G,J,K	40	250/500	2900	0.17	600
SDWL2012C16N □ STF	16	G,J,K	50	250/500	3300	0.2	600
SDWL2012C18N □ STF	18	G,J,K	50	250/500	3300	0.2	600
SDWL2012C20N □ STF	20	G,J,K	35	200/200	3000	0.17	500
SDWL2012C22N □ STF	22	G,J,K	55	250/500	2000	0.22	500
SDWL2012C23N □ STF	23	G,J,K	55	250/500	2000	0.22	500
SDWL2012C24N □ STF	24	G,J,K	50	250/500	2000	0.22	500
SDWL2012C25N □ STF	25	G,J,K	40	250/250	2000	0.55	500
SDWL2012C26N □ STF	26	G,J,K	60	50/1500	2500	0.1	500
SDWL2012C26N8 □ STF	26.8	G,J,K	35	300/250	2500	0.25	500
SDWL2012C27N □ STF	27	G,J,K	55	250/500	2500	0.25	500
SDWL2012C28N □ STF	28	G,J,K	50	250/500	2500	0.25	500
SDWL2012C29N □ STF	29	G,J,K	45	250/500	1800	0.25	500
SDWL2012C30N □ STF	30	G,J,K	50	250/500	2100	0.27	500
SDWL2012C31N □ STF	31	G,J,K	50	250/500	2000	0.27	500
SDWL2012C33N □ STF	33	G,J,K	60	250/500	2000	0.27	500
SDWL2012C36N □ STF	36	G,J,K	55	250/500	1700	0.27	500
SDWL2012C39N □ STF	39	G,J,K	60	250/500	2000	0.29	500
SDWL2012C43N □ STF	43	G,J,K	50	200/500	1600	0.34	500
SDWL2012C45N □ STF	45	G,J,K	50	200/500	1600	0.31	500
SDWL2012C47N □ STF	47	G,J,K	50	200/500	1600	0.31	500
SDWL2012C51N □ STF	51	G,J,K	45	200/500	1600	0.38	500
SDWL2012C55N □ STF	55	G,J,K	55	200/500	1550	0.32	500
SDWL2012C56N □ STF	56	G,J,K	55	200/500	1550	0.32	500
SDWL2012C62N □ STF	62	G,J,K	50	200/500	1400	0.35	500
SDWL2012C66N □ STF	66	G,J,K	45	200/500	1200	0.4	500
SDWL2012C68N □ STF	68	G,J,K	55	200/500	1450	0.38	500
SDWL2012C70N □ STF	70	G,J,K	60	200/500	1400	0.38	500

## SPECIFICATIONS SDWL2012C TYPE

Part Number	Inductance	Tolerance	Min. Quality Factor	L/Q Test Freq.	Min.Self-resonant Frequency	Max. DC Resistance	Max. Rated Current
Units	nH	-	-	MHz	MHz	$\Omega$	mA
Symbol	L	-	Q	Freq.	S.R.F	DCR	I <sub>r</sub>
SDWL2012C72N □ STF	72	G,J,K	50	200/500	1400	0.3	400
SDWL2012C75N □ STF	75	G,J,K	50	150/500	1400	0.4	400
SDWL2012C78N □ STF	78	G,J,K	60	150/500	1400	0.42	400
SDWL2012C82N □ STF	82	G,J,K	50	150/500	1300	0.42	400
SDWL2012C85N □ STF	85	G,J,K	40	150/150	1020	0.42	400
SDWL2012C89N □ STF	89	G,J,K	60	150/500	1300	0.4	400
SDWL2012C91N □ STF	91	G,J,K	65	150/500	1200	0.48	400
SDWL2012C92N □ STF	92	G,J,K	45	150/500	1300	0.42	350
SDWL2012CR10 □ STF	100	G,J,K	50	150/500	1200	0.46	400
SDWL2012CR11 □ STF	110	G,J,K	50	150/250	1100	0.48	400
SDWL2012CR12 □ STF	120	G,J,K	50	150/250	1100	0.51	400
SDWL2012CR13 □ STF	130	G,J,K	55	150/250	1200	0.5	400
SDWL2012CR14 □ STF	140	G,J,K	50	100/250	1100	0.56	400
SDWL2012CR144 □ STF	144	G,J,K	50	100/250	1000	0.52	400
SDWL2012CR15 □ STF	150	G,J,K	50	100/250	920	0.56	400
SDWL2012CR16 □ STF	160	G,J,K	45	100/250	900	0.8	400
SDWL2012CR18 □ STF	180	G,J,K	50	100/250	870	0.64	400
SDWL2012CR20 □ STF	200	G,J,K	45	100/250	900	0.64	400
SDWL2012CR22 □ STF	220	G,J,K	45	100/250	850	1.1	400
SDWL2012CR23 □ STF	230	G,J,K	40	100/250	770	1.2	400
SDWL2012CR24 □ STF	240	G,J,K	40	100/250	770	1.2	400
SDWL2012CR27 □ STF	270	G,J,K	38	100/250	650	1	350
SDWL2012CR28 □ STF	280	G,J,K	38	100/100	750	1.2	150
SDWL2012CR29 □ STF	290	G,J,K	38	100/100	750	1.2	150
SDWL2012CR30 □ STF	300	G,J,K	40	100/250	750	1.5	310
SDWL2012CR33 □ STF	330	G,J,K	40	100/250	600	1.4	310
SDWL2012CR35 □ STF	350	G,J,K	35	100/250	500	1.4	300
SDWL2012CR36 □ STF	360	G,J,K	35	100/250	560	1.5	290
SDWL2012CR39 □ STF	390	G,J,K	35	100/250	560	1.5	290
SDWL2012CR41 □ STF	410	G,J,K	35	100/250	560	1.5	290
SDWL2012CR43 □ STF	430	G,J,K	28	50/100	430	1.2	230
SDWL2012CR47 □ STF	470	G,J,K	33	50/100	375	1.72	250
SDWL2012CR49 □ STF	490	G,J,K	33	50/100	330	1.8	230
SDWL2012CR50 □ STF	500	G,J,K	23	25/50	330	1.8	230
SDWL2012CR51 □ STF	510	G,J,K	20	25/50	300	1.5	230
SDWL2012CR54 □ STF	540	G,J,K	23	25/50	300	1.9	230
SDWL2012CR56 □ STF	560	G,J,K	23	25/50	320	1.9	230
SDWL2012CR62 □ STF	620	G,J,K	23	25/50	280	1.95	200
SDWL2012CR65 □ STF	650	G,J,K	23	25/50	270	2	200
SDWL2012CR68 □ STF	680	G,J,K	23	25/50	270	2.05	190
SDWL2012CR72 □ STF	720	G,J,K	22	25/50	240	2.1	180
SDWL2012CR75 □ STF	750	G,J,K	23	25/50	240	2.1	180
SDWL2012CR82 □ STF	820	G,J,K	23	25/50	250	2.3	180
SDWL2012CR86 □ STF	860	G,J,K	22	25/50	230	2.3	160
SDWL2012CR91 □ STF	910	G,J,K	22	25/50	230	2.4	160
SDWL2012C1R0 □ STF	1000	G,J,K	20	25/50	200	2.5	150
SDWL2012C1R2 □ STF	1200	G,J,K	18	25/50	200	3.5	100
SDWL2012C1R5 □ STF	1500	G,J,K	15	25/50	130	2.9	100
SDWL2012C1R8 □ STF	1800	G,J,K	15	7.9/25	120	3.5	120
SDWL2012C2R0 □ STF	2000	G,J,K	15	7.9/25	80	4.3	100
SDWL2012C2R2 □ STF	2200	G,J,K	16	7.9/25	70	4.6	100
SDWL2012C2R7 □ STF	2700	G,J,K	15	7.9/7.9	120	5	80

## SPECIFICATIONS SDWL2012C TYPE

Part Number	Inductance	Tolerance	Min. Quality Factor	L/Q Test Freq.	Min.Self-resonant Frequency	Max. DC Resistance	Max. Rated Current
Units	nH	-	-	MHz	MHz	Ω	mA
Symbol	L	-	Q	Freq.	S.R.F	DCR	Ir
SDWL2012C3R3 □ STF	3300	G,J,K	10	7.9/7.9	80	5.4	50
SDWL2012C3R9 □ STF	3900	G,J,K	10	7.9/7.9	80	5.4	40
SDWL2012C4R7 □ STF	4700	G,J,K	18	7.9/25	70	8.2	30

## SDWL2520C TYPE

Part Number	Inductance	Tolerance	Min. Quality Factor	L/Q Test Freq.	Min.Self-resonant Frequency	Max. DC Resistance	Max. Rated Current
Units	nH	-	-	MHz	MHz	Ω	mA
Symbol	L	-	Q	Freq.	S.R.F	DCR	Ir
SDWL2520C3N6 □ STF	3.6	J,K	50	50/1500	>6000	0.05	1000
SDWL2520C3N9 □ STF	3.9	J,K	50	50/1500	>6000	0.1	1000
SDWL2520C4N1 □ STF	4.1	J,K	75	50/1500	>6000	0.05	1000
SDWL2520C4N7 □ STF	4.7	J,K	50	50/1500	>6000	0.11	1000
SDWL2520C5N6 □ STF	5.6	J,K	55	50/1500	>6000	0.14	1000
SDWL2520C6N8 □ STF	6.8	J,K	45	250/250	>6000	0.08	1000
SDWL2520C8N2 □ STF	8.2	J,K	60	50/1500	5500	0.05	1000
SDWL2520C10N □ STF	10	G,J,K	50	50/500	4100	0.08	1000
SDWL2520C12N □ STF	12	G,J,K	50	50/500	3300	0.09	1000
SDWL2520C15N □ STF	15	G,J,K	50	50/500	2500	0.13	1000
SDWL2520C16N □ STF	16	G,J,K	35	50/350	2500	0.2	1000
SDWL2520C18N □ STF	18	G,J,K	50	50/350	2500	0.11	1000
SDWL2520C20N □ STF	20	G,J,K	50	50/350	2400	0.12	900
SDWL2520C22N □ STF	22	G,J,K	55	50/350	2400	0.12	1000
SDWL2520C24N □ STF	24	G,J,K	55	50/350	1600	0.13	1000
SDWL2520C27N □ STF	27	G,J,K	55	50/350	1600	0.13	1000
SDWL2520C28N □ STF	28	G,J,K	70	50/350	1800	0.095	1000
SDWL2520C30N □ STF	30	G,J,K	45	50/350	1700	0.2	1000
SDWL2520C33N □ STF	33	G,J,K	60	50/350	1600	0.14	1000
SDWL2520C36N □ STF	36	G,J,K	60	50/350	1600	0.14	1000
SDWL2520C39N □ STF	39	G,J,K	50	50/350	1500	0.15	1000
SDWL2520C43N □ STF	43	G,J,K	65	50/350	1600	0.16	1000
SDWL2520C44N □ STF	44	G,J,K	60	50/350	1500	0.15	1000
SDWL2520C47N □ STF	47	G,J,K	65	50/350	1500	0.16	1000
SDWL2520C48N □ STF	48	G,J,K	60	50/350	1400	0.16	1000
SDWL2520C51N □ STF	51	G,J,K	65	50/350	1150	0.2	1000
SDWL2520C52N □ STF	52	G,J,K	65	50/350	1150	0.2	1000
SDWL2520C56N □ STF	56	G,J,K	50	50/350	1300	0.18	1000
SDWL2520C60N □ STF	60	G,J,K	50	50/350	1200	0.21	1000
SDWL2520C62N □ STF	62	G,J,K	50	50/350	1200	0.21	1000
SDWL2520C64N □ STF	64	G,J,K	65	50/350	1200	0.19	1000
SDWL2520C65N □ STF	65	G,J,K	50	50/350	1200	0.12	1000
SDWL2520C66N □ STF	66	G,J,K	60	50/350	1200	0.19	800
SDWL2520C68N □ STF	68	G,J,K	65	50/350	1200	0.21	1000
SDWL2520C72N □ STF	72	G,J,K	50	50/350	1200	0.22	900
SDWL2520C75N □ STF	75	G,J,K	50	50/350	1200	0.22	900
SDWL2520C80N □ STF	80	G,J,K	60	50/350	1000	0.22	1000
SDWL2520C82N □ STF	82	G,J,K	60	50/350	800	0.22	1000
SDWL2520C91N □ STF	91	G,J,K	55	50/350	800	0.3	800
SDWL2520CR10 □ STF	100	G,J,K	60	25/350	1000	0.56	650
SDWL2520CR11 □ STF	110	G,J,K	35	100/100	950	0.85	650
SDWL2520CR12 □ STF	120	G,J,K	60	25/350	950	0.63	650

## SPECIFICATIONS SDWL2520C TYPE

Part Number	Inductance	Tolerance	Min. Quality Factor	L/Q Test Freq.	Min. Self-resonant Frequency	Max. DC Resistance	Max. Rated Current
Units	nH	-	-	MHz	MHz	$\Omega$	mA
Symbol	L	-	Q	Freq.	S.R.F	DCR	I <sub>r</sub>
SDWL2520CR13 □ STF	130	G,J,K	70	25/350	950	0.045	650
SDWL2520CR15 □ STF	150	G,J,K	50	25/100	800	0.62	580
SDWL2520CR17 □ STF	170	G,J,K	45	25/100	650	0.77	500
SDWL2520CR18 □ STF	180	G,J,K	50	25/100	750	0.7	620
SDWL2520CR20 □ STF	200	G,J,K	45	25/100	700	0.45	450
SDWL2520CR22 □ STF	220	G,J,K	50	25/100	630	0.8	500
SDWL2520CR23 □ STF	230	G,J,K	50	25/100	600	0.85	500
SDWL2520CR24 □ STF	240	G,J,K	50	25/100	550	0.9	500
SDWL2520CR26 □ STF	260	G,J,K	50	25/100	600	0.91	500
SDWL2520CR27 □ STF	270	G,J,K	50	25/100	600	0.91	500
SDWL2520CR29 □ STF	290	G,J,K	45	25/100	550	1	500
SDWL2520CR30 □ STF	300	G,J,K	45	25/100	450	1	500
SDWL2520CR33 □ STF	330	G,J,K	50	25/100	530	1.05	450
SDWL2520CR35 □ STF	350	G,J,K	50	25/100	500	1.06	470
SDWL2520CR36 □ STF	360	G,J,K	50	25/100	500	1.06	470
SDWL2520CR39 □ STF	390	G,J,K	50	25/100	480	1.12	470
SDWL2520CR40 □ STF	400	G,J,K	50	25/100	480	1.12	470
SDWL2520CR43 □ STF	430	G,J,K	50	25/100	480	1.15	450
SDWL2520CR47 □ STF	470	G,J,K	50	25/100	450	1.19	470
SDWL2520CR50 □ STF	500	G,J,K	30	25/25	400	0.9	200
SDWL2520CR51 □ STF	510	G,J,K	50	25/100	380	1.25	420
SDWL2520CR52 □ STF	520	G,J,K	50	25/100	380	1.25	420
SDWL2520CR53 □ STF	530	G,J,K	50	25/100	380	1.25	420
SDWL2520CR54 □ STF	540	G,J,K	45	25/100	435	1.3	400
SDWL2520CR56 □ STF	560	G,J,K	50	25/100	390	1.33	400
SDWL2520CR62 □ STF	620	G,J,K	45	25/100	375	1.4	300
SDWL2520CR64 □ STF	640	G,J,K	45	25/100	375	1.47	300
SDWL2520CR68 □ STF	680	G,J,K	45	25/100	360	1.47	400
SDWL2520CR72 □ STF	720	G,J,K	45	25/100	370	1.47	360
SDWL2520CR75 □ STF	750	G,J,K	45	25/100	360	1.54	360
SDWL2520CR77 □ STF	770	G,J,K	45	25/100	350	1.54	360
SDWL2520CR82 □ STF	820	G,J,K	45	25/100	330	1.61	400
SDWL2520CR86 □ STF	860	G,J,K	40	25/100	330	1.61	380
SDWL2520CR91 □ STF	910	G,J,K	35	25/50	295	1.68	380
SDWL2520C1R0 □ STF	1000	G,J,K	35	25/50	270	1.8	370
SDWL2520C1R2 □ STF	1200	G,J,K	35	7.9/50	200	2	310
SDWL2520C1R5 □ STF	1500	G,J,K	28	7.9/50	150	2.3	330
SDWL2520C1R8 □ STF	1800	G,J,K	28	7.9/50	120	2.6	300
SDWL2520C2R0 □ STF	2000	G,J,K	22	7.9/25	100	2.8	280
SDWL2520C2R2 □ STF	2200	G,J,K	22	7.9/25	100	2.8	280
SDWL2520C2R7 □ STF	2700	G,J,K	22	7.9/25	90	3.2	290
SDWL2520C3R0 □ STF	3000	G,J,K	20	7.9/25	50	3.2	290
SDWL2520C3R3 □ STF	3300	G,J,K	22	7.9/25	70	3.4	290
SDWL2520C3R6 □ STF	3600	G,J,K	20	7.9/25	60	3.8	250
SDWL2520C3R9 □ STF	3900	G,J,K	17	7.9/25	60	3.6	260
SDWL2520C4R3 □ STF	4300	G,J,K	13	7.9/25	30	3.9	260
SDWL2520C4R7 □ STF	4700	G,J,K	20	7.9/25	50	4	260
SDWL2520C5R1 □ STF	5100	G,J,K	20	7.9/25	40	6.2	200
SDWL2520C5R6 □ STF	5600	G,J,K	20	7.9/25	40	5.7	240
SDWL2520C6R8 □ STF	6800	G,J,K	20	7.9/25	40	7.7	200
SDWL2520C7R5 □ STF	7500	G,J,K	20	7.9/25	50	10	180
SDWL2520C8R2 □ STF	8200	G,J,K	20	7.9/7.9	30	10.7	150



## SPECIFICATIONS SDWL2520C TYPE

Part Number	Inductance	Tolerance	Min. Quality Factor	L/Q Test Freq.	Min. Self-resonant Frequency	Max. DC Resistance	Max. Rated Current
Units	nH	-	-	MHz	MHz	Ω	mA
Symbol	L	-	Q	Freq.	S.R.F	DCR	I <sub>r</sub>
SDWL2520C9R1 □ STF	9100	G,J,K	18	7.9/25	40	12	80
SDWL2520C100 □ STF	10000	G,J,K	20	7.9/7.9	40	8.5	100
SDWL2520C180 □ STF	18000	G,J,K	15	7.9/7.9	10	13	80
SDWL2520C220 □ STF	22000	G,J,K	20	7.9/7.9	20	18	70

## SDWL3216C TYPE

Part Number	Inductance	Tolerance	Min. Quality Factor	L/Q Test Freq.	Min. Self-resonant Frequency	Max. DC Resistance	Max. Rated Current
Units	nH	-	-	MHz	MHz	Ω	mA
Symbol	L	-	Q	Freq.	S.R.F	DCR	I <sub>r</sub>
SDWL3216C3N3 □ STF	3.3	J,K	20	100/300	6200	0.07	1000
SDWL3216C5N6 □ STF	5.6	J,K	30	100/300	5500	0.07	1000
SDWL3216C6N8 □ STF	6.8	J,K	30	100/300	5500	0.07	1000
SDWL3216C8N2 □ STF	8.2	J,K	30	100/300	5500	0.12	900
SDWL3216C10N □ STF	10	G,J,K	40	100/300	4000	0.09	1000
SDWL3216C12N □ STF	12	G,J,K	40	100/300	3200	0.09	1000
SDWL3216C15N □ STF	15	G,J,K	40	100/300	3200	0.12	1000
SDWL3216C18N □ STF	18	G,J,K	45	100/300	2800	0.12	1000
SDWL3216C22N □ STF	22	G,J,K	50	100/300	2200	0.12	1000
SDWL3216C27N □ STF	27	G,J,K	50	100/300	1800	0.12	1000
SDWL3216C30N □ STF	30	G,J,K	50	100/300	1800	0.12	1000
SDWL3216C33N □ STF	33	G,J,K	50	100/300	1800	0.12	1000
SDWL3216C39N □ STF	39	G,J,K	50	100/300	1800	0.12	1000
SDWL3216C47N □ STF	47	G,J,K	50	100/300	1500	0.13	1000
SDWL3216C56N □ STF	56	G,J,K	55	100/300	1450	0.14	1000
SDWL3216C68N □ STF	68	G,J,K	55	100/300	1200	0.26	900
SDWL3216C82N □ STF	82	G,J,K	55	100/300	1200	0.21	900
SDWL3216CR10 □ STF	100	G,J,K	55	100/300	1100	0.3	850
SDWL3216CR12 □ STF	120	G,J,K	60	100/300	1100	0.3	800
SDWL3216CR15 □ STF	150	G,J,K	55	100/300	950	0.31	750
SDWL3216CR18 □ STF	180	G,J,K	60	50/300	900	0.43	700
SDWL3216CR22 □ STF	220	G,J,K	60	50/300	760	0.56	670
SDWL3216CR27 □ STF	270	G,J,K	50	50/300	730	0.56	630
SDWL3216CR29 □ STF	290	G,J,K	50	50/250	700	0.6	610
SDWL3216CR33 □ STF	330	G,J,K	45	50/150	650	0.7	590
SDWL3216CR39 □ STF	390	G,J,K	45	50/150	600	0.8	530
SDWL3216CR47 □ STF	470	G,J,K	45	50/150	550	1.3	490
SDWL3216CR56 □ STF	560	G,J,K	45	35/150	470	1.34	460
SDWL3216CR62 □ STF	620	G,J,K	50	35/150	450	1.58	430
SDWL3216CR68 □ STF	680	G,J,K	45	35/150	450	1.58	430
SDWL3216CR82 □ STF	820	G,J,K	45	35/150	420	1.82	400
SDWL3216CR91 □ STF	910	G,J,K	45	35/150	400	2.6	320
SDWL3216C1R0 □ STF	1000	G,J,K	45	35/150	400	2.8	320
SDWL3216C1R2 □ STF	1200	G,J,K	45	35/150	380	3.2	300

## SPECIFICATIONS SDWL3225C TYPE

Part Number	Inductance	Tolerance	Min. Quality Factor	L/Q Test Freq.	Min.Self-resonant Frequency	Max. DC Resistance	Max. Rated Current
Units	nH	-	-	MHz	MHz	Ω	mA
Symbol	L	-	Q	Freq.	S.R.F	DCR	I <sub>r</sub>
SDWL3225C3N9 □ STF	3.9	J,K	30	100/300	6000	0.05	1000
SDWL3225C4N7 □ STF	4.7	J,K	30	100/300	5800	0.065	1000
SDWL3225C8N2 □ STF	8.2	J,K	30	100/300	5500	0.07	1000
SDWL3225C10N □ STF	10	G,J,K	40	100/300	4000	0.08	1000
SDWL3225C12N □ STF	12	G,J,K	40	100/300	3200	0.08	1000
SDWL3225C15N □ STF	15	G,J,K	40	100/300	3200	0.1	1000
SDWL3225C18N □ STF	18	G,J,K	50	100/300	2800	0.1	1000
SDWL3225C22N □ STF	22	G,J,K	50	100/300	2200	0.1	1000
SDWL3225C27N □ STF	27	G,J,K	50	100/300	1800	0.11	1000
SDWL3225C30N □ STF	30	G,J,K	50	100/300	1800	0.11	900
SDWL3225C33N □ STF	33	G,J,K	55	100/300	1800	0.11	1000
SDWL3225C39N □ STF	39	G,J,K	55	100/300	1500	0.12	1000
SDWL3225C43N □ STF	43	G,J,K	55	100/300	1500	0.12	1000
SDWL3225C47N □ STF	47	G,J,K	55	100/300	1500	0.13	1000
SDWL3225C51N □ STF	51	G,J,K	50	100/300	1500	0.14	1000
SDWL3225C56N □ STF	56	G,J,K	55	100/300	1450	0.14	1000
SDWL3225C68N □ STF	68	G,J,K	55	100/300	1200	0.15	900
SDWL3225C82N □ STF	82	G,J,K	55	100/300	1000	0.2	900
SDWL3225CR10 □ STF	100	G,J,K	55	100/300	900	0.2	850
SDWL3225CR12 □ STF	120	G,J,K	60	100/300	800	0.25	800
SDWL3225CR13 □ STF	130	G,J,K	60	100/300	700	0.25	750
SDWL3225CR15 □ STF	150	G,J,K	60	100/300	700	0.25	750
SDWL3225CR18 □ STF	180	G,J,K	60	50/300	650	0.3	700
SDWL3225CR22 □ STF	220	G,J,K	60	50/300	650	0.4	770
SDWL3225CR24 □ STF	240	G,J,K	60	50/300	580	0.4	500
SDWL3225CR27 □ STF	270	G,J,K	40	50/300	580	0.4	630
SDWL3225CR29 □ STF	290	G,J,K	45	50/150	580	0.45	600
SDWL3225CR33 □ STF	330	G,J,K	45	50/150	580	0.58	590
SDWL3225CR39 □ STF	390	G,J,K	45	50/150	510	0.58	530
SDWL3225CR47 □ STF	470	G,J,K	45	50/150	480	0.8	490
SDWL3225CR56 □ STF	560	G,J,K	45	35/150	420	1.1	460
SDWL3225CR60 □ STF	600	G,J,K	45	35/150	420	1.15	450
SDWL3225CR68 □ STF	680	G,J,K	45	35/150	400	1.2	430
SDWL3225CR82 □ STF	820	G,J,K	45	35/150	370	1.82	400
SDWL3225C1R0 □ STF	1000	G,J,K	45	35/150	340	1.85	320
SDWL3225C1R2 □ STF	1200	G,J,K	35	35/150	220	1.87	300
SDWL3225C1R5 □ STF	1500	G,J,K	20	7.9/50	160	1.95	310
SDWL3225C1R8 □ STF	1800	G,J,K	30	7.9/50	160	2.25	310
SDWL3225C2R2 □ STF	2200	G,J,K	25	7.9/50	130	2.41	310
SDWL3225C2R7 □ STF	2700	G,J,K	25	7.9/50	110	2.85	300
SDWL3225C3R0 □ STF	3000	G,J,K	20	7.9/25	110	3.12	300
SDWL3225C3R3 □ STF	3300	G,J,K	20	7.9/25	100	3.14	290
SDWL3225C3R9 □ STF	3900	G,J,K	20	7.9/25	60	3.6	290
SDWL3225C4R7 □ STF	4700	G,J,K	20	7.9/25	60	4	280
SDWL3225C5R6 □ STF	5600	G,J,K	15	7.9/25	50	5	250
SDWL3225C6R8 □ STF	6800	G,J,K	15	7.9	40	8	230
SDWL3225C8R2 □ STF	8200	G,J,K	15	7.9	40	9	200
SDWL3225C8R6 □ STF	8600	G,J,K	15	7.9	40	9	200
SDWL3225C100 □ STF	10000	G,J,K	15	7.9	35	13.2	120
SDWL3225C220 □ STF	22000	G,J,K	15	7.9	20	18	100

**SPECIFICATIONS** SDWL4532C TYPE

Part Number	Inductance	Tolerance	Min. Quality Factor	L/Q Test Freq.	Min.Self-resonant Frequency	Max. DC Resistance	Max. Rated Current
Units	uH	-	-	MHz	MHz	Ω	mA
Symbol	L	-	Q	Freq.	S.R.F	DCR	I <sub>r</sub>
SDWL4532C24N □ STF	0.024	G,J,K	30	7.9/50	2000	0.1	1000
SDWL4532C82N □ STF	0.082	G,J,K	30	7.9/50	700	0.4	500
SDWL4532C90N □ STF	0.090	G,J,K	30	7.9/50	700	0.45	500
SDWL4532C93N □ STF	0.093	G,J,K	30	7.9/50	700	0.45	500
SDWL4532CR10 □ STF	0.100	G,J,K	30	7.9/50	700	0.5	500
SDWL4532CR12 □ STF	0.120	G,J,K	30	7.9/50	700	0.5	500
SDWL4532CR15 □ STF	0.150	G,J,K	75	7.9/100	700	0.3	1000
SDWL4532CR18 □ STF	0.180	G,J,K	30	7.9/50	700	0.6	500
SDWL4532CR22 □ STF	0.220	G,J,K	80	7.9/100	750	0.35	900
SDWL4532CR27 □ STF	0.270	G,J,K	60	50/50	580	0.16	900
SDWL4532CR33 □ STF	0.330	G,J,K	80	7.9/100	485	0.42	850
SDWL4532CR68 □ STF	0.668	G,J,K	50	7.9/50	400	0.9	500
SDWL4532C1R0 □ STF	1.0	G,J,K	60	7.9/50	250	1.2	480
SDWL4532C1R1 □ STF	1.1	G,J,K	50	100/100	240	1.2	480
SDWL4532C1R2 □ STF	1.2	G,J,K	60	7.9/50	230	1.2	480
SDWL4532C1R5 □ STF	1.5	G,J,K	60	7.9/50	210	1.6	430
SDWL4532C1R6 □ STF	1.6	G,J,K	60	7.9/50	210	1.6	430
SDWL4532C1R8 □ STF	1.8	G,J,K	55	7.9/50	150	2	380
SDWL4532C2R1 □ STF	2.1	G,J,K	55	7.9/50	150	2.2	340
SDWL4532C2R2 □ STF	2.2	G,J,K	55	7.9/50	150	2.2	340
SDWL4532C2R7 □ STF	2.7	G,J,K	55	7.9/50	150	3.2	300
SDWL4532C3R3 □ STF	3.3	G,J,K	55	7.9/50	130	3.8	270
SDWL4532C3R9 □ STF	3.9	G,J,K	55	7.9/50	120	5	240
SDWL4532C4R7 □ STF	4.7	G,J,K	55	7.9/50	90	5.4	230
SDWL4532C5R6 □ STF	5.6	G,J,K	45	7.9/50	90	5.7	220
SDWL4532C6R2 □ STF	6.2	G,J,K	35	7.9/50	80	6.4	200
SDWL4532C6R8 □ STF	6.8	G,J,K	30	7.9/50	80	6.6	210
SDWL4532C8R2 □ STF	8.2	G,J,K	20	7.9/50	70	7	200
SDWL4532C100 □ STF	10	G,J,K	15	7.9/50	60	7.7	190
SDWL4532C120 □ STF	12	G,J,K	30	2.5/10	50	8.7	180
SDWL4532C150 □ STF	15	G,J,K	30	2.5/10	30	9.6	170
SDWL4532C180 □ STF	18	G,J,K	25	2.5/10	30	10.5	160
SDWL4532C220 □ STF	22	G,J,K	25	2.5/10	20	11.5	155
SDWL4532C270 □ STF	27	G,J,K	25	2.5/10	20	12.5	150
SDWL4532C330 □ STF	33	G,J,K	10	2.5/10	10	13.5	145

※: Please refer to "Measurement Notice for RF Inductors"

**TYPICAL ELECTRICAL CHARACTERISTICS**

**SDWL2012C TYPE**  
Inductance vs. Frequency Characteristics

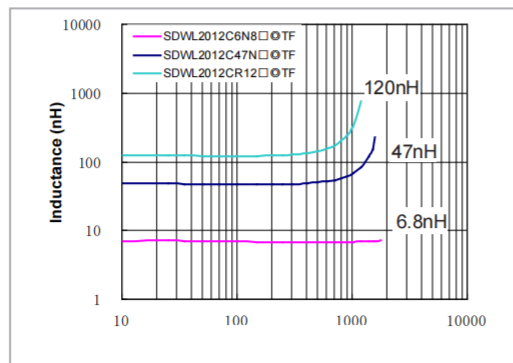

Q vs. Frequency Characteristics

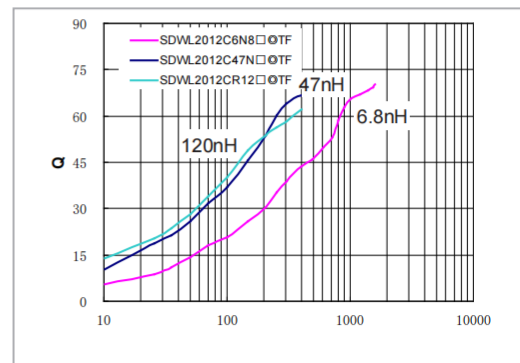

Multilayer Chip Ferrite Inductor  
Multilayer Chip Inductor for Choke  
Multilayer Chip Power Inductor  
Multilayer Ultra High Q Chip Ceramic Inductor  
Multilayer High Q Chip Ceramic Inductor  
Multilayer Chip Ceramic Inductor  
Multilayer High Frequency Chip Ceramic Inductor  
Wire Wound Chip Ferrite Inductor  
Wire Wound Chip Ferrite Inductor  
SMD Power Inductor



**TYPICAL ELECTRICAL CHARACTERISTICS**

**SDWL2520C TYPE**

Inductance vs. Frequency Characteristics

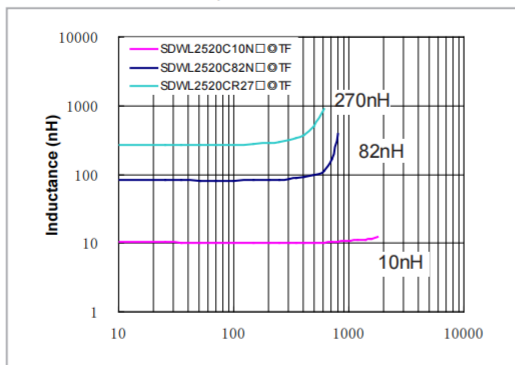

Q vs. Frequency Characteristics

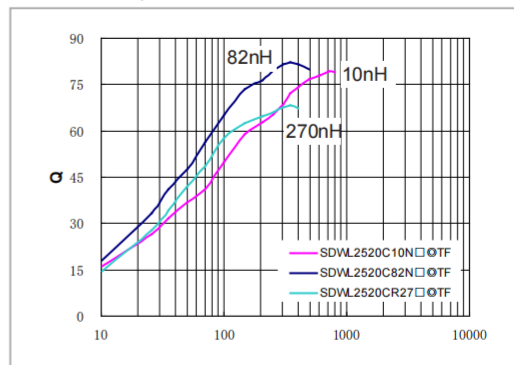

**SDWL3216C TYPE**

Inductance vs. Frequency Characteristics

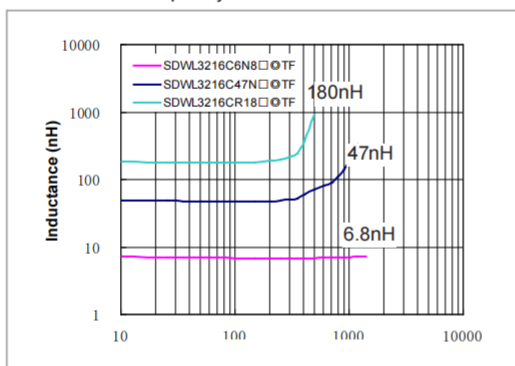

Q vs. Frequency Characteristics

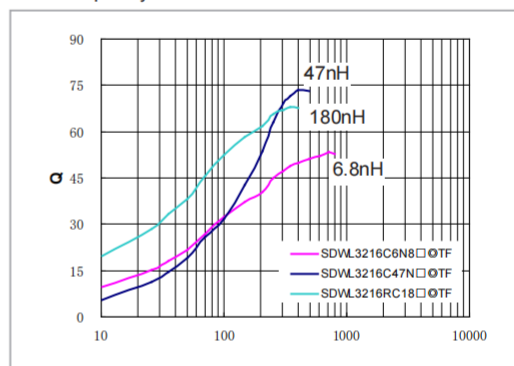

**SDWL3225C TYPE**

Inductance vs. Frequency Characteristics

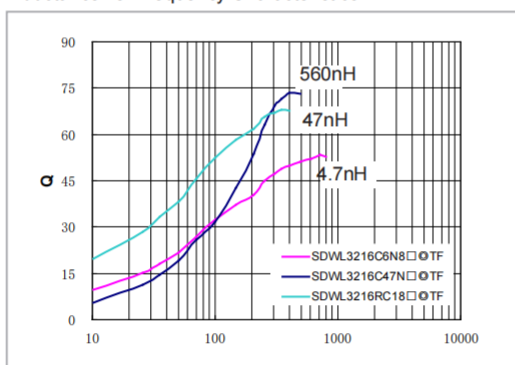

Q vs. Frequency Characteristics

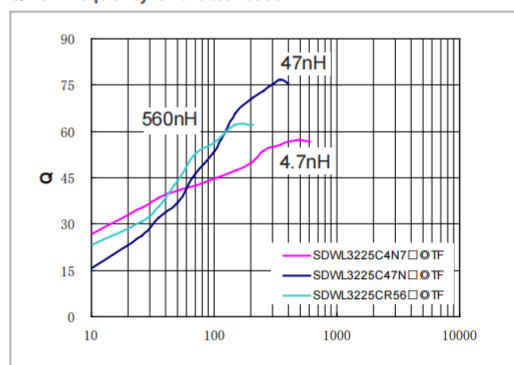

**SDWL4532C TYPE**

Inductance vs. Frequency Characteristics

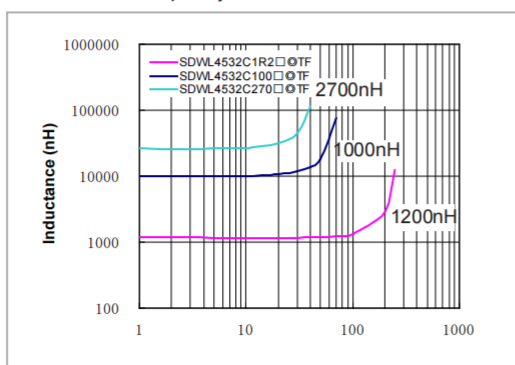

Q vs. Frequency Characteristics

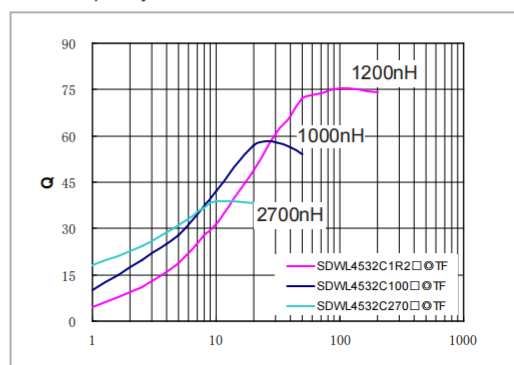

单击下面可查看定价，库存，交付和生命周期等信息

[>>Sunlord\(顺络\)](#)