

This specification applies to the SLO160808T Series of wire wound SMD power inductor.

2. Product Description and Identification (Part Number)

1) Description:

SLO160808T series of Wire wound SMD power inductor.

2) Product Identification (Part Number)

SLO	160808	T	1R0	M	T	T
(1)	(2)	(3)	(4)	(5)	(6)	(7)

(1) Series Type

(2) Dimension: LxWxH

(3) Material Code

(4) Inductance:R68=0.68uH;1R0=1.0μH

(5) Inductance Tolerance:M=± 20%,N=± 30%

(6) Company Code

(7) Packaging: packed in embossed carrier tape

3. Electrical Characteristics

Please refer to Item 5.

1) Operating temperature range (individual chip without packing): -40°C ~ +125°C (Including Self-heating) .

2) Storage temperature range (packaging conditions): -10°C ~ +40°C and RH 70% (Max.).

4. Shape and Dimensions (Unit:mm)

Dimensions and recommended PCB pattern for reflow soldering, please see Fig4-1 and Table4-1

Shape and Dimensions:

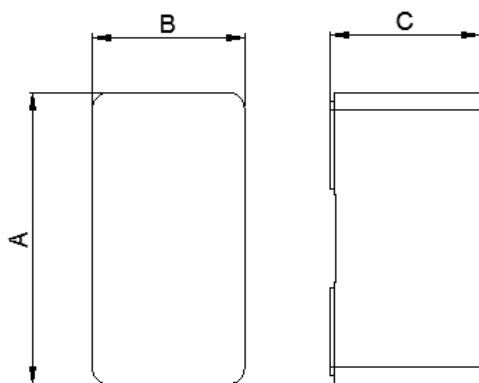

Recommended pad:

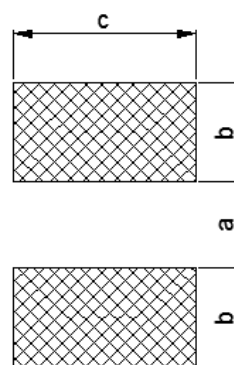

Table 4-1

Fig4-1

A	B	C	D	a	b	c
1.6±0.2	0.8±0.2	0.90Max	0.50±0.2	0.70 Ref	0.55 Ref	1.0 Ref

5. Electrical Characteristics

Part Number	Inductance	DC Resistance		Saturation Current		Heat Rating Current	
	1MHz/1V	Max.	Typ.	Max.	Typ.	Min.	Typ.
Units	uH	Ω	Ω	A	A	A	A
Symbol	L	DCR		Isat		Irms	
SLO160808T1R0MTT	1.0 \pm 20%	0.140	0.115	2.0	2.3	1.3	1.6
SLO160808T2R2MTT	2.2 \pm 20%	0.300	0.250	1.2	1.4	0.9	1.0

Note:※1: Rated current: Isat(max.)or Irms(max.),whichever is smaller;

※2: Saturation Current: Max. Value, DC current at which the inductance drops less than 30% from its value without current; Typ. Value, DC current at which the inductance drops 30% from its value without current;

※3: Irms: DC current that causes the temperature rise (ΔT) from 20°C ambient.

For Max. Value, $\Delta T < 40^\circ\text{C}$; for Typ. Value, ΔT is approximate 40°C.

The part temperature (ambient + temp. rise) should not exceed 125°C under worst case operating conditions. Circuit design, component placement, PCB trace size and thickness, airflow and other cooling provisions all affect the part temperature. Part temperature should be verified in the end application.

※4:Absolute maximum voltage:DC 20V

6. Structure

The structure of SLO160808T product.

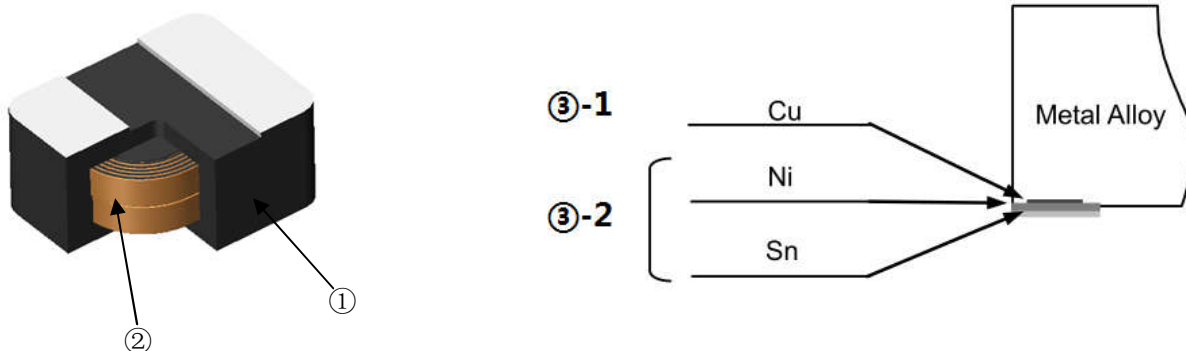

NO.	Components	Material
①	Core	Soft magnetic Metal
②	Wire	Polyurethane system enameled copper wire
③-1	Electrodes	Inside Cu
③-2		Ni+Sn Plating Chemicals

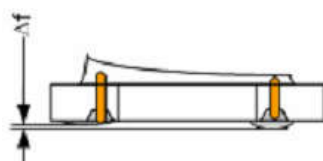

Δf : Clearance between terminal and the surface of plate must be 0.12mm max when coil is placed on a flat plate.

7. Reliability Test

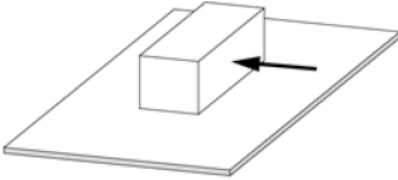
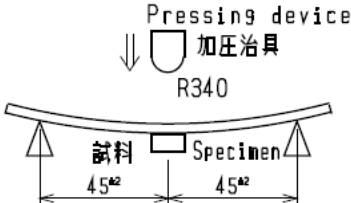
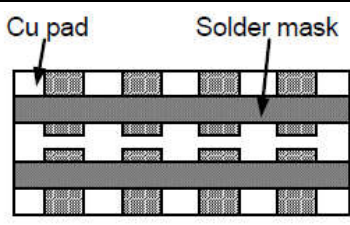
Items	Requirements	Test Methods and Remarks
7.1 Bonding Strength		It shall be soldered on the substrate. Applying Force(F): 10N Hold Duration: 5s 
7.2 Bending Strength	Chip coil shall not be damaged.	Substrate: Glass-epoxy substrate (100×40×1.0mm) Speed of Applying Force: 0.5mm / s Deflection: 2mm Hold Duration: 20s 
7.3 Vibration	No visible mechanical damage. Inductance change: Within $\pm 10\%$  Glass Epoxy Board	1) Solder the inductor to the testing jig (glass epoxy board) using eutectic solder. 2) The inductor shall be subjected to a simple harmonic motion having total amplitude of 1.5mm, the frequency being varied uniformly between the approximate limits of 10 and 55Hz. 3) The frequency range from 10 to 55Hz and return to 10Hz shall be traversed in approximately 1 minute. this motion shall be applied for a period of 2 hours in each 3mutually perpendicular directions (total of 6 hours).
7.4 Solderability	The wetting area of the electrode shall be at least 90% covered with new solder coating.	Flux: Ethanol solution of rosin, 25(wt)% Solder : Sn-3.0Ag-0.5Cu Pre-Heating: 150±10°C / 60 to 90s Solder Temperature: 245±5°C Immersion Time: 3 s
7.5 Resistance to Soldering Heat	Appearance: No damage Inductance Change : within $\pm 10\%$	Reflow soldering method Flux: Ethanol solution of rosin, 25(wt)% Solder: Sn-3.0Ag-0.5Cu Pre-Heating: 150 to 180°C / 60 to 120s Solder Temperature: 230°C min. / 20 to 40s Peak Temperature: 250+5/-0°C Reflow times: 2 times max Test board shall be 0.8 mm thick. Base material shall be glass epoxy resin. Then measured after exposure Standard atmospheric conditions for 1~2h.

7. Reliability Test

Items	Requirements	Test Methods and Remarks
7.6 Heat Resistance	Appearance:No damage Inductance Change : within $\pm 10\%$	Temperature: $125\pm 2^{\circ}\text{C}$ Time: 500h ($\pm 12\text{h}$) Then measured after exposure Standard atmospheric conditions for 1~2h.
7.7 Cold Resistance		Temperature: $-40\pm 2^{\circ}\text{C}$ Time: 500h ($\pm 12\text{h}$) Then measured after exposure Standard atmospheric conditions for 1~2h.
7.8 Humidity		Temperature: $40\pm 2^{\circ}\text{C}$ Humidity: 90 to 95%(RH) Time: 500h ($\pm 12\text{h}$) Then measured after
7.9 Temperature Cycle		1 cycle: 1 step: $-40\pm 2^{\circ}\text{C}$ / 30 $\pm 3\text{m}$ 2 step: Ordinary temp. / 3m max. 3 step: $+125\pm 2^{\circ}\text{C}$ / 30 $\pm 3\text{m}$ 4 step: Ordinary temp. / 3m max. Total of 100 cycles Then measured after exposure Standard atmospheric conditions for 1~2h.

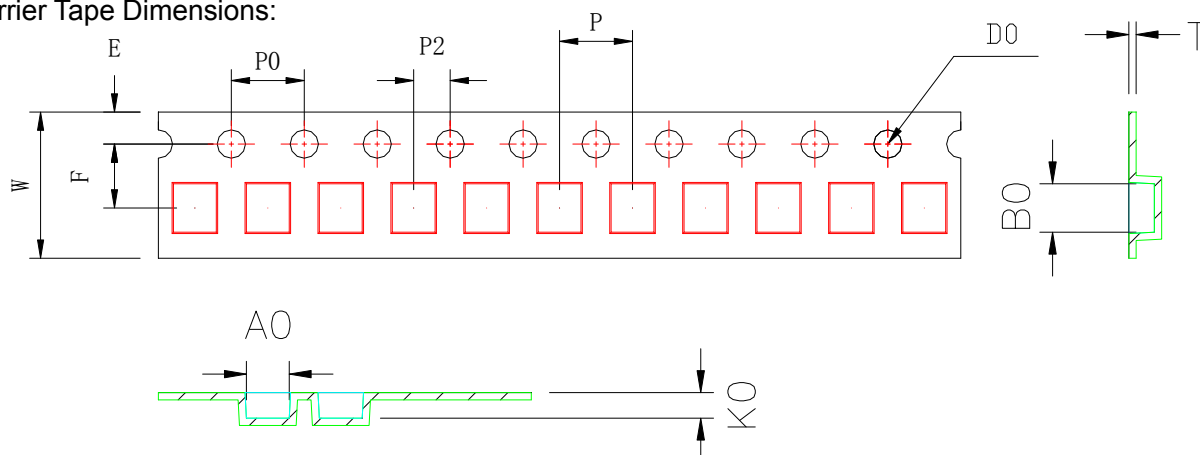
8.Packaging and Marking:
8-1.Carrier Tape Dimensions:

ITEM	W	A0	B0	K0	P	F	E	D0	P0	P2	T
DIM	8.00	1.0	1.80	1.10	4.00	3.5	1.75	1.50	4.00	2.00	0.20
TOLE	±0.3	±0.1	±0.1	±0.1	±0.1	±0.1	±0.1	+0.1	±0.1	±0.1	±0.05

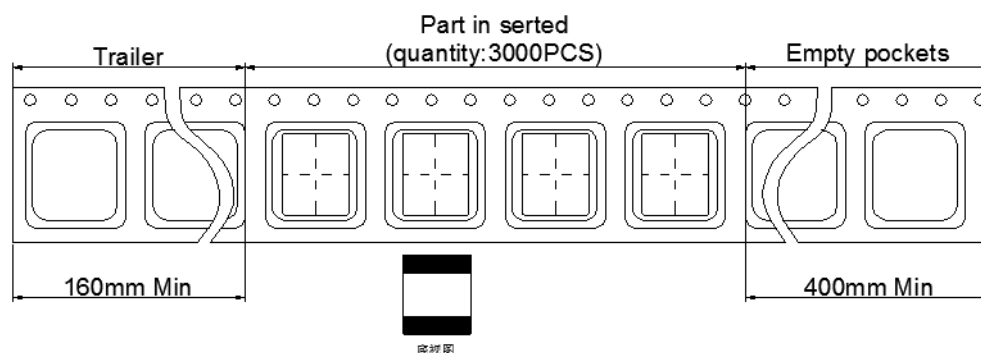
8-2.Taping Dimensions:

8-3.Reel Dimensions:

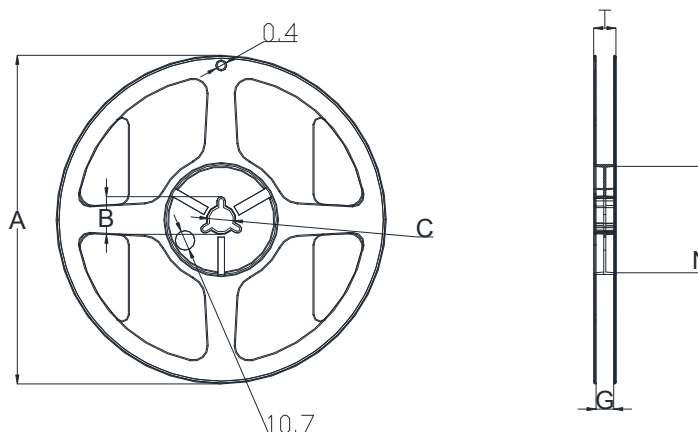
Carrier Tape Reel



Type	A	B	C	G	N	T
8mm	178	20.7±0.8	13±0.4	9	60	10.8

8-4. Packaging Quantity:

3KPCS/ Reel

单击下面可查看定价，库存，交付和生命周期等信息

[>>Sunltech\(韩国顺磁\)](#)