

VOLTAGE RANGE: 50 - 1000V
CURRENT: 1.0 A

Features

- Diffused Junction
- Low Forward Voltage Drop
- High Current Capability
- High Reliability
- High Surge Current Capability

Mechanical Data

- Case: DO - 41 Molded Plastic
- Terminals: Plated Leads Solderable per MIL-STD-202, Method 208
- Polarity: Cathode Band
- Weight: 0.34 grams (approx.)
- Mounting Position: Any
- Marking: Type Number

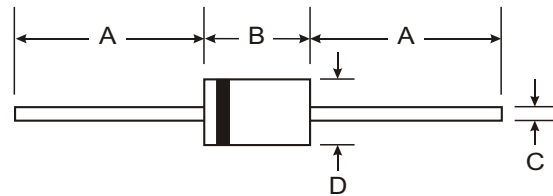
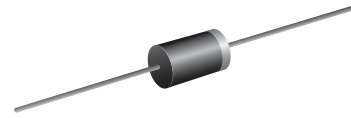

DO-41		
Dim	Min	Max
A	25.40	—
B	4.06	5.21
C	0.71	0.864
D	2.00	2.72
All Dimensions in mm		

Maximum Ratings and Electrical Characteristics T_A = 25°C unless otherwise specified

Single phase, half wave, 60Hz, resistive or inductive load. For capacitive load, derate current by 20%.

Characteristic	Symbol	UF 4001	UF 4002	UF 4003	UF 4004	UF 4005	UF 4006	UF 4007	Unit
Peak Repetitive Reverse Voltage Working Peak Reverse Voltage DC Blocking Voltage	V _{RRM} V _{RWM} V _R	50	100	200	400	600	800	1000	V
RMS Reverse Voltage	V _{R(RMS)}	35	70	140	280	420	560	700	V
Average Rectified Output Current (Note 1) @T_A = 55°C	I _O	1.0							A
Non-Repetitive Peak Forward Surge Current 8.3ms Single half sine-wave superimposed on rated load (JEDEC Method)	I _{FSM}	30							A
Forward Voltage @I_F = 1.0A	V _{FM}	1.0		1.3		1.7			V
Peak Reverse Current @T_A = 25°C At Rated DC Blocking Voltage @T_A = 100°C	I _{RM}	5.0 100							μA
Reverse Recovery Time (Note 2)	t _{rr}	50				75			nS
Typical Junction Capacitance (Note 3)	C _j	20				10			pF
Operating Temperature Range	T _j	-65 to +125							°C
Storage Temperature Range	T _{STG}	-65 to +150							°C

Note: 1. Leads maintained at ambient temperature at a distance of 9.5mm from the case
 2. Measured with I_F = 0.5A, I_R = 1.0A, I_{RR} = 0.25A. See figure 5.
 3. Measured at 1.0 MHz and applied reverse voltage of 4.0V D.C.

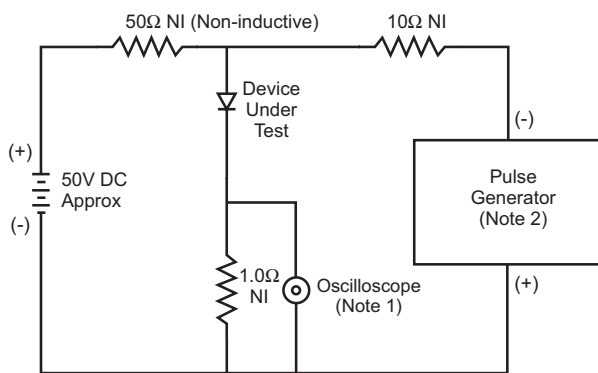
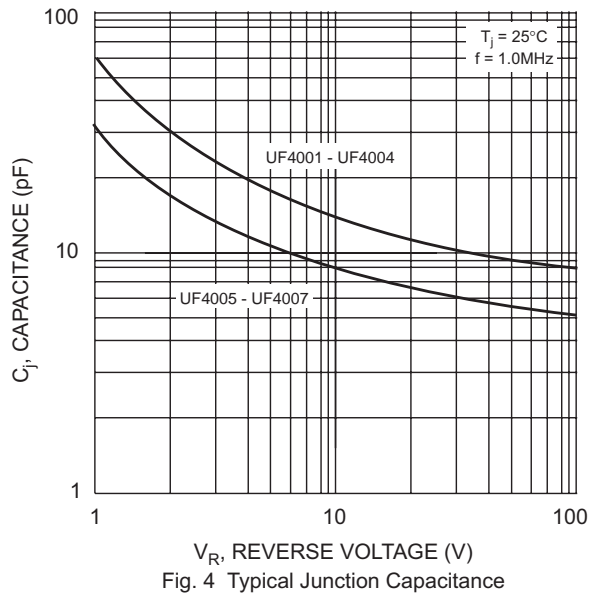
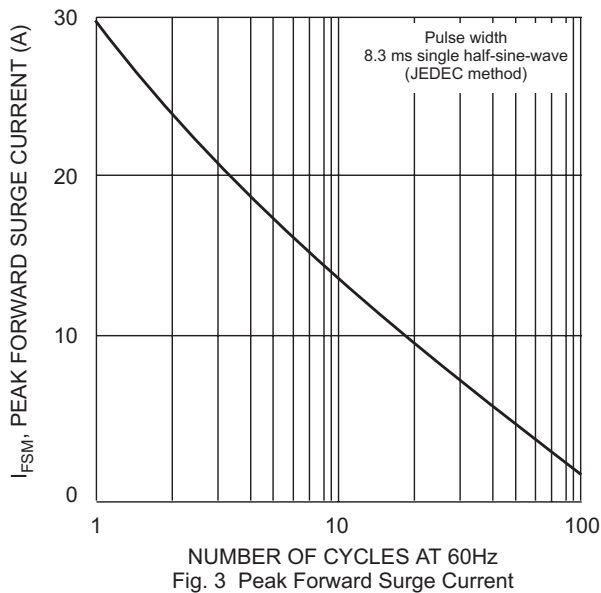
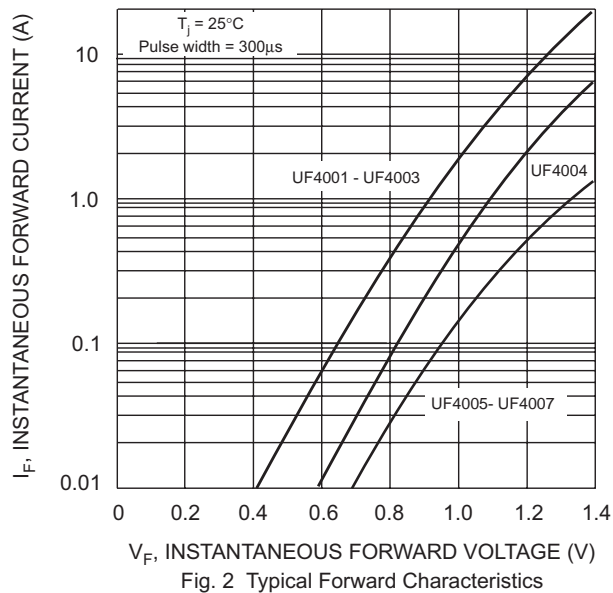
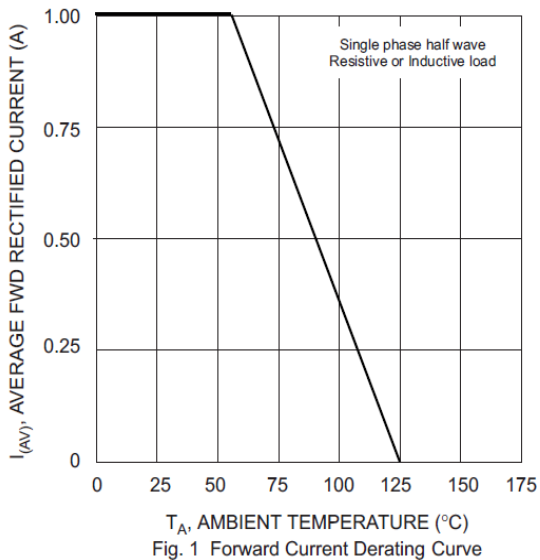

- Notes:
1. Rise Time = 7.0ns max. Input Impedance = 1.0M Ω , 22pF.
 2. Rise Time = 10ns max. Input Impedance = 50 Ω .

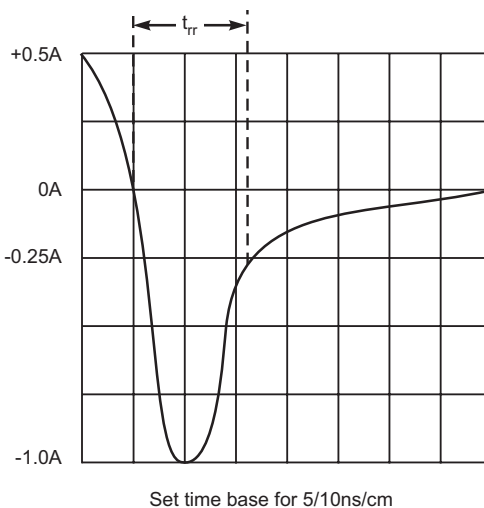

Fig. 5 Reverse Recovery Time Characteristic and Test Circuit

单击下面可查看定价，库存，交付和生命周期等信息

[>>SUNMATE\(森美特\)](#)