

Features

- Low Forward Voltage (V_F) Drop with Positive Temperature Coefficient
- Zero Reverse Recovery Current / Forward Recovery Voltage
- Temperature-Independent Switching Behavior

Applications

- Battery Chargers
- Solar & Renewable Energy Power Conversion
- Industrial Power Supplies
- Boost Diodes in PFC & DC-DC

Part Number	Package	Marking
GC4D40120H	T0-247-2	GC4D40120



TO-247-2

Package



Maximum Ratings ($T_c = 25^\circ\text{C}$ unless otherwise specified)

Parameter	Symbol	Value	Unit	Test Conditions	Note
Repetitive Peak Reverse Voltage	V_{RRM}	1200	V		
DC Blocking Voltage	V_{DC}	1200			
Continuous Forward Current	I_F	128	A	$T_j = 25^\circ\text{C}$	Fig. 3
		88		$T_j = 100^\circ\text{C}$	
		41		$T_j = 155^\circ\text{C}$	
Repetitive Peak Forward Surge Current	I_{FRM}	161	A	$T_c = 25^\circ\text{C}, t_p = 10\text{ ms}, \text{Half Sine Pulse}$	
		91		$T_c = 110^\circ\text{C}, t_p = 10\text{ ms}, \text{Half Sine Pulse}$	
Non-Repetitive Forward Surge Current	I_{FSM}	247	A	$T_c = 25^\circ\text{C}, t_p = 10\text{ ms}, \text{Half Sine Pulse}$	
		245		$T_c = 110^\circ\text{C}, t_p = 10\text{ ms}, \text{Half Sine Pulse}$	
Power Dissipation	P_{tot}	667	W	$T_c = 25^\circ\text{C}$	Fig. 4
		289		$T_c = 110^\circ\text{C}$	
i^2t Value	$\int i^2t$	305	A^2s	$T_c = 25^\circ\text{C}, t_p = 10\text{ ms}$	
		300		$T_c = 110^\circ\text{C}, t_p = 10\text{ ms}$	

Electrical Characteristics

Parameter	Symbol	Typ.	Max.	Units	Test Conditions	Note
Forward Voltage	V_F	1.5	1.8	V	$I_F = 40 \text{ A}, T_J = 25 \text{ }^\circ\text{C}$	Fig. 1
		2.2	3		$I_F = 40 \text{ A}, T_J = 175 \text{ }^\circ\text{C}$	
Reverse Current	I_R	45	300	μA	$V_R = 1200 \text{ V}, T_J = 25 \text{ }^\circ\text{C}$	Fig. 2
		75	500		$V_R = 1200 \text{ V}, T_J = 175 \text{ }^\circ\text{C}$	
Total Capacitive Charge	Q_C	167		nC	$V_R = 800 \text{ V}, T_J = 25 \text{ }^\circ\text{C}$	Fig. 5
Total Capacitance	C	2,809		pF	$V_R = 0 \text{ V}, T_J = 25 \text{ }^\circ\text{C}, f = 1 \text{ MHz}$	Fig. 6
		174			$V_R = 400 \text{ V}, T_J = 25 \text{ }^\circ\text{C}, f = 1 \text{ MHz}$	
		145			$V_R = 800 \text{ V}, T_J = 25 \text{ }^\circ\text{C}, f = 1 \text{ MHz}$	
Capacitance Stored Energy	E_C	36		μJ	$V_R = 800 \text{ V}$	Fig. 7

Note:
SiC Schottky Diodes are majority carrier devices, so there is no reverse recovery charge.

Thermal & Mechanical Characteristics

Parameter	Symbol	Value	Units	Note
Thermal Resistance, Junction to Case (Typ.)	$R_{\theta,JC}$	0.225	$^\circ\text{C} / \text{W}$	
Operating Junction & Storage Temperature	T_J, T_{stg}	-55 to +175	$^\circ\text{C}$	Fig. 8
Maximum Processing Temperature	T_{PROC}	325		10 min. Maximum

Electrostatic Discharge (ESD) Classifications

Parameter	Symbol	Value
Human Body Model	HBM	Class 3B ($\geq 8000 \text{ V}$)
Charge Device Model	CDM	Class C3 ($\geq 1000 \text{ V}$)

Typical Performance

Figure 1. Forward Characteristics

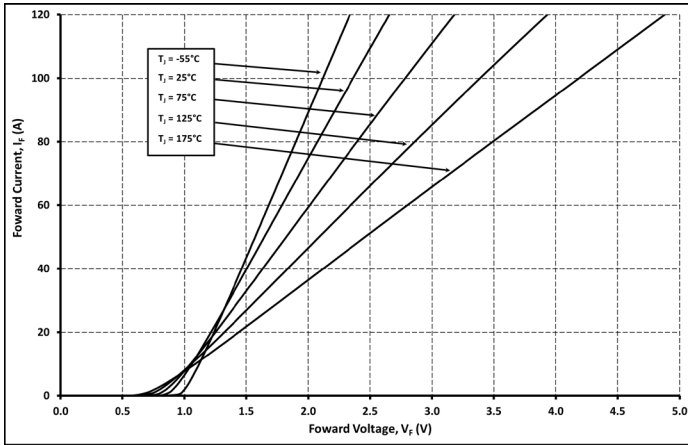

Figure 2. Reverse Characteristics

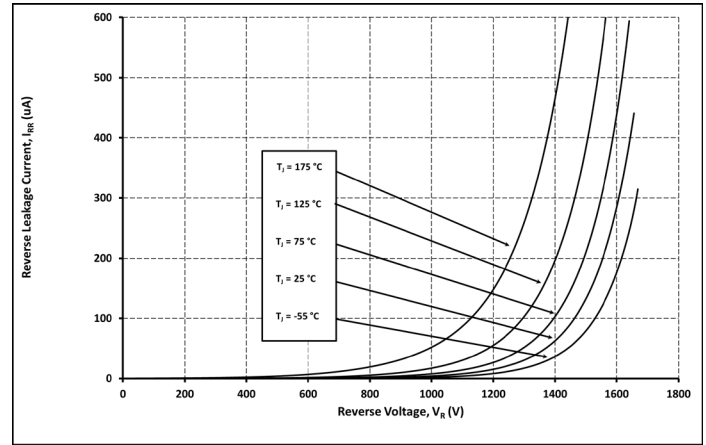

Figure 3. Current Derating

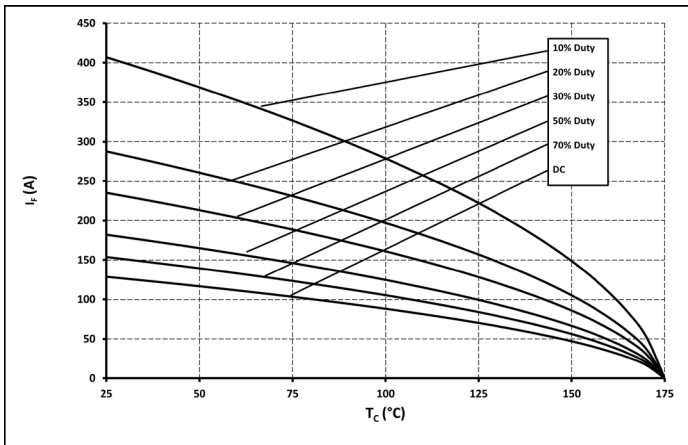

Figure 4. Power Derating

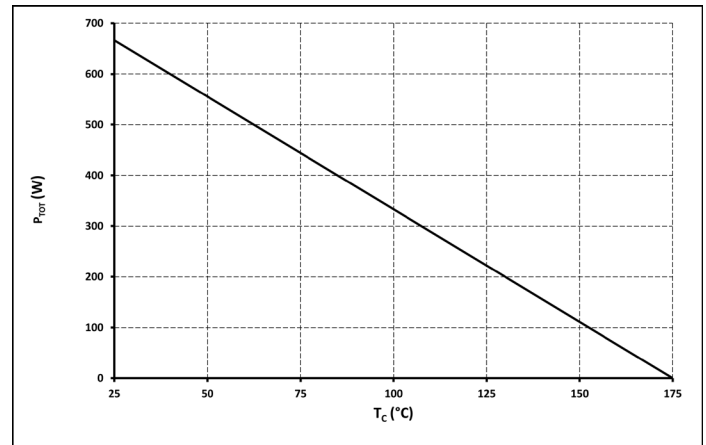

Figure 5. Total Capacitance Charge vs. Reverse Voltage

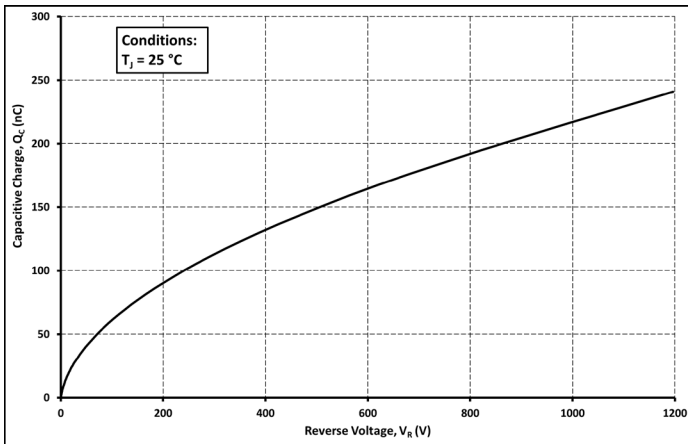
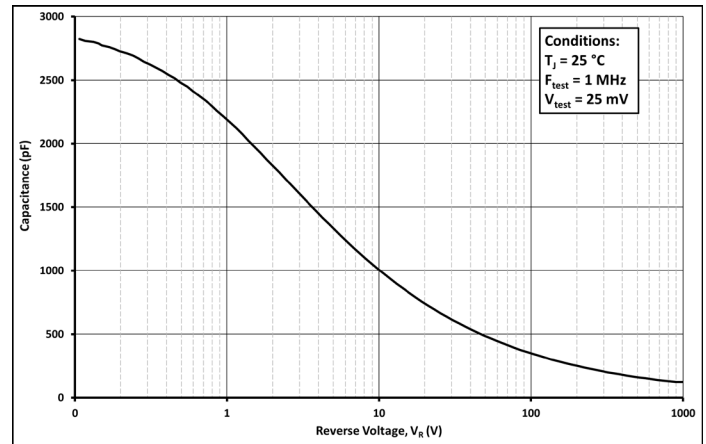

Figure 6. Capacitance vs. Reverse Voltage



Typical Performance

Figure 7. Capacitance Stored Energy

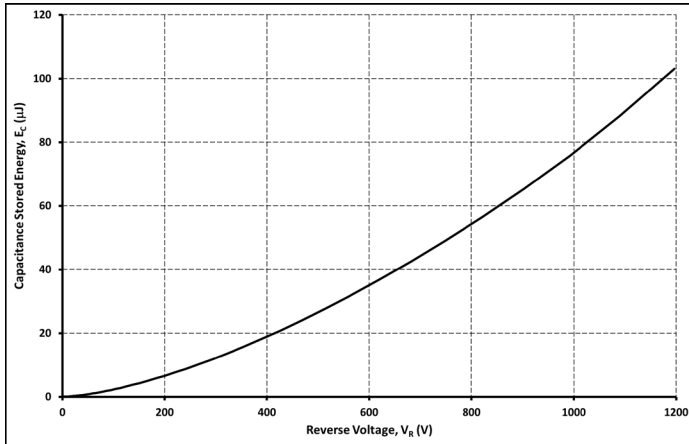
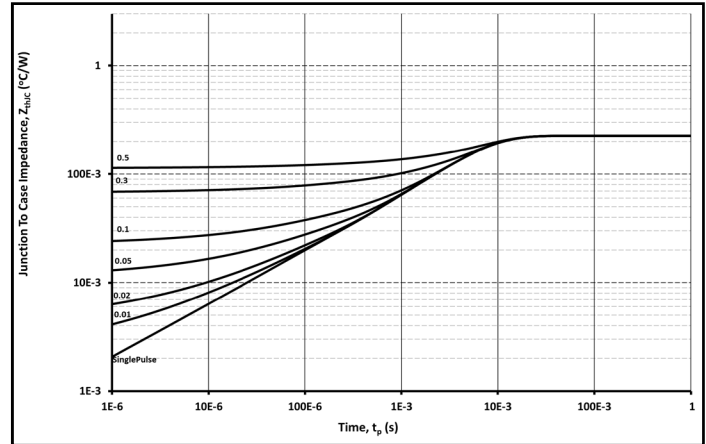

Figure 8. Transient Thermal Impedance



Package Dimensions

Package: TO-247-2

All dimensions in mm.

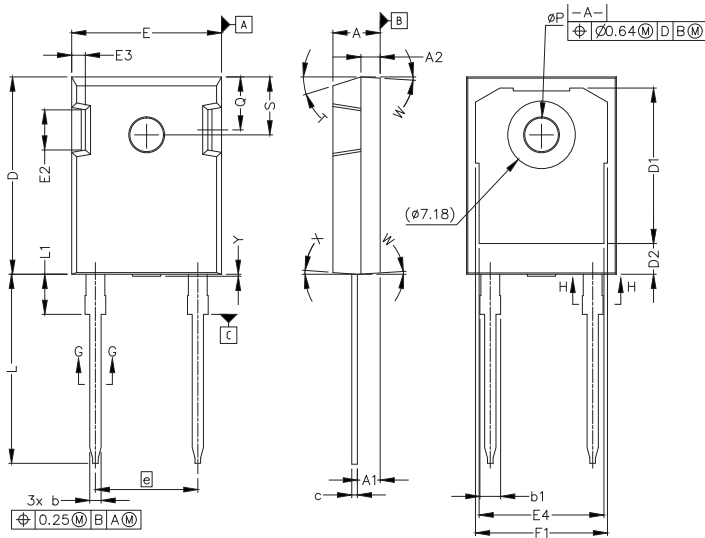

SYM	MILLIMETERS		INCHES	
	MIN	MAX	MIN	MAX
A	4.83	5.21	.190	.205
A1	2.29	2.54	.090	.100
A2	1.91	2.16	.075	.085
b'	1.07	1.28	.042	.050
b	1.07	1.33	.042	.052
b1	1.91	2.41	.075	.095
b2	1.91	2.16	.075	.085
c'	0.55	0.65	.022	.026
c	0.55	0.68	.022	.027
D	20.80	21.10	.819	.831
D1	16.25	17.35	.640	.683
D2	2.86	3.16	.112	.124
E	15.75	16.13	.620	.635
E1	13.10	14.15	.516	.557
E2	3.68	5.10	.145	.201
E3	1.00	1.90	.039	.075
E4	12.38	13.43	.487	.529
e	10.88 BSC		.428 BSC	
L	19.81	20.32	.780	.800
L1	4.10	4.40	.161	.173
ØP	3.51	3.65	.138	.144
Q	5.49	6.00	.216	.236
S	6.04	6.30	.238	.248
T	17.5° REF.			
W	3.5° REF.			
X	4° REF.			
Y	0	0.50	0	0.020

Recommended Solder Pad Layout

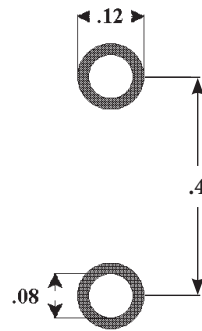

TO-247-2

all units are in inches

单击下面可查看定价，库存，交付和生命周期等信息

[>>SUPSiC\(国晶微\)](#)