



Parameter	Symbol	Rating	Units
Load Voltage	$V_L$	60	V
Load Current	$I_L$	0.4	A
On-Resistance	$R_{on}$	1.0	$\Omega$
I/O Breakdown Voltage	$V_{io}$	5000	Vrms



SMD-8

DIP-8

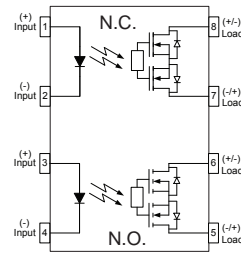

(1) 1a1b 2input

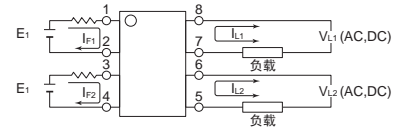

(2) 1a1b 1input

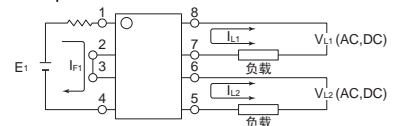

### SUPSiC PhotoRelays

- Long life (No limit on mechanical and electrical lifetime) Bounce-free switching
- Higher speed and high frequency switching
- Higher sensitivity (less power consumption)
- Immunity to EMI or RFI
- No have voltaic arc, bounce, and noise More
- resistant to vibration and impact AC or DC load
- switching
- Small package size

### Applications

- Telecom/Datacom switching
- Multiplexers
- Meter reading systems
- Data acquisition
- Medical equipment
- Battery monitoring
- I/O Sub-Systems
- Robotics
- Aerospace
- Home/Safety security systems
- Process Control
- Energy Management
- Reed Relay EMR Replacement
- Programmable Controllers

### TPYES

Category	Output Rating		Package	Part No.	Packing Quantity
	Load Voltage	Load Current			
AC/DC	60V	400mA	DIP-8	GAQW612E	50pcs /tube
			SMD-8	GAQW612EH	1000pcs /reel

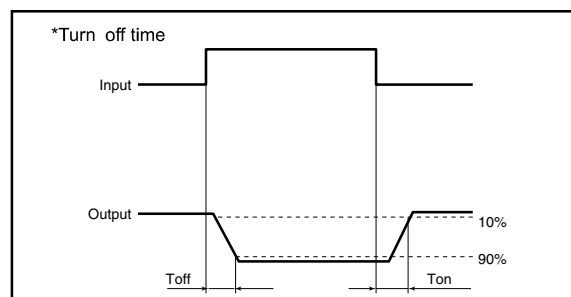
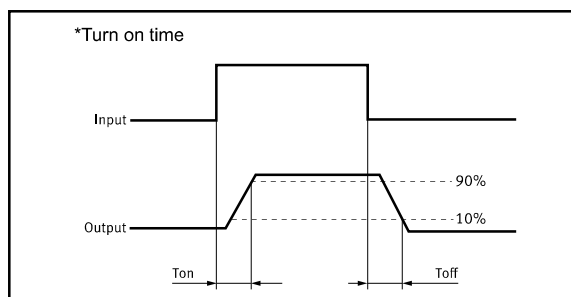

## Absolute Maximum Ratings (Ta = 25°C)

Item		Symbol	Value	Units	Note
Input	Continuous LED Current	IF	50	mA	
	Peak LED Current	IFP	1000	mA	f=100Hz, duty=1%
	LED Reverse Voltage	VR	5	V	
	Input Power Dissipation	Pin	75	mW	
Output	Load Voltage	VL	60	V(AC peak or DC)	
	Load Current	IL	400	mA	
	Peak Load Current	IPeak	700	mA	1ms(1 pulse)
	Output Power Dissipation	Pout	450	mW	
Total Power Dissipation		PT	500	mW	
I/O Breakdown Voltage		VI/O	5000	Vrms	RH=60%, 1min
Operating Temperature		TOpr	-40 to +85	-40 to +85	
Storage Temperature		TStg	-40 to +100	-40 to +100	
Pin Soldering Temperature		TSol	260	260	10 sec max.

## Electrical Characteristics (Ta = 25°C)

Item		Symbol	MIN.	TYP.	MAX.	Units	Conditions
Input	LED Forward Voltage	VF		1.2	1.4	V	IF=10mA
	Operation LED Current	IF On		0.5	5.0	mA	
	Recovery LED Current	IF Off		0.35	0.5	mA	
	Recovery LED Voltage	VF Off	0.5			V	
Output	On-Resistance	ROn		1(N.O.)	1.4(N.O.)	Ω	IF=5mA (N.O.) IF=0mA (N.C) IL=100mA Time to flow is within 1 sec.
				6(N.C.)	10(N.C.)		
	Off-State Leakage Current	ILeak		1	10	uA	IF=0mA (N.O.) IF=5mA (N.C) VL= Rating
	Output Capacitance	COut		150		pF	IF=5mA,VL=0, f=1MHz
Transmission	Turn-On Time	TOn		0.23(N.O.)	0.5(N.O.)	ms	IF=5mA, IL=Max
				0.2(N.C.)	1.0(N.C.)		
	Turn-Off Time	TOff		0.03(N.O.)	0.2(N.O.)	ms	
				0.5(N.C.)	3.0(N.C.)		
Coupled	I/O Isolation Resistance	RI/O	10 <sup>10</sup>			Ω	DC500V
	I/O Capacitance	CI/O		0.8		pF	f=1MHz

Please obey the following conditions to ensure proper device operation and resetting. Input LED current (Recommended value): IF ≥5mA and ≤30mA

## Engineering Data

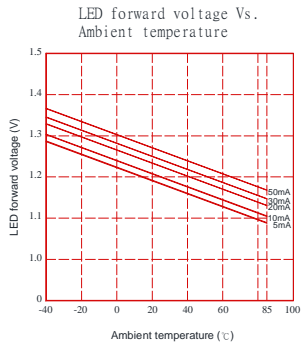
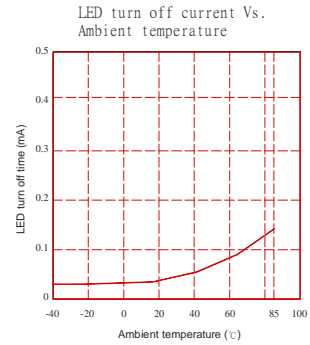
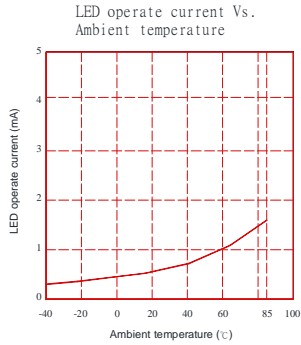
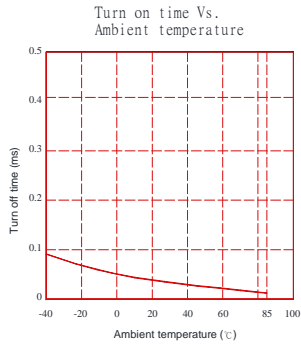
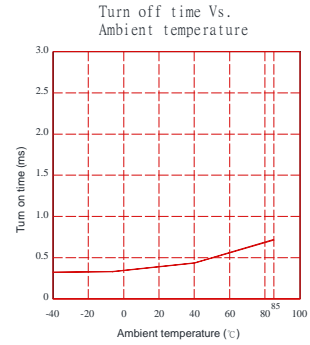
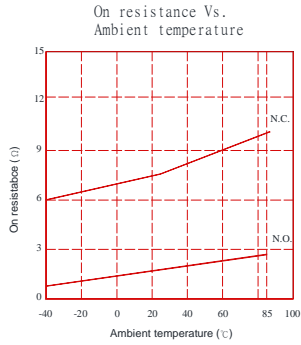
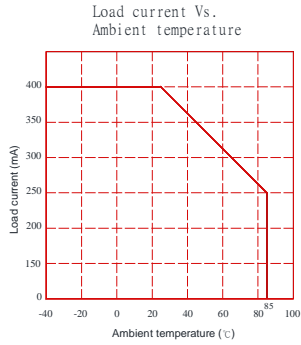

Voltage Vs. current characteristics of output at MOS portion

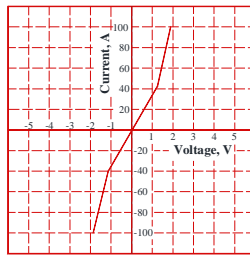

Off state leakage current

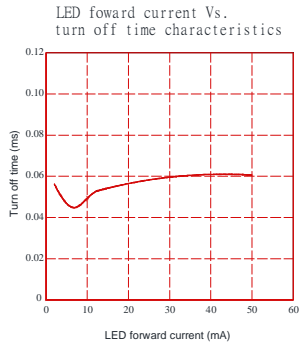
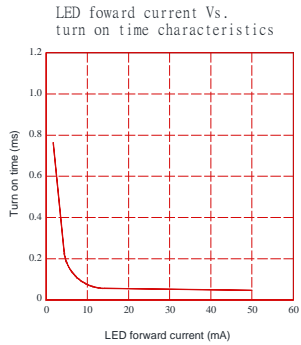
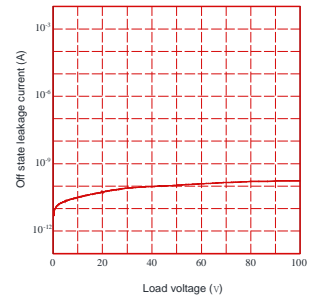

Applied voltage Vs. output capacitance characteristics

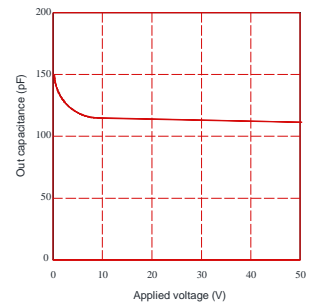

## Dimensions and DIP-8 Package Unit: mm

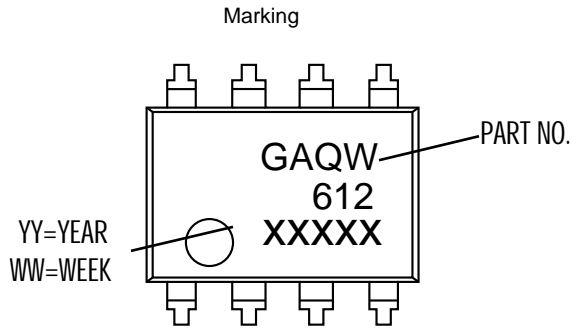

### Through hole terminal type

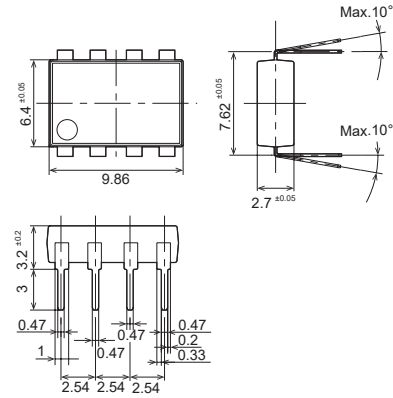

### PC board pattern (Bottom view)

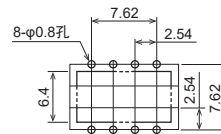

## DIP Tape dimensions Unit: mm

Devices are packaged in a tube so that pin No. 1 is on the stopper B side. Observe correct orientation when mounting them on PC boards.

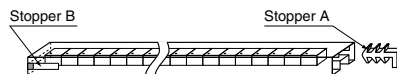

## Dimensions and SMD-8 Package Unit: mm

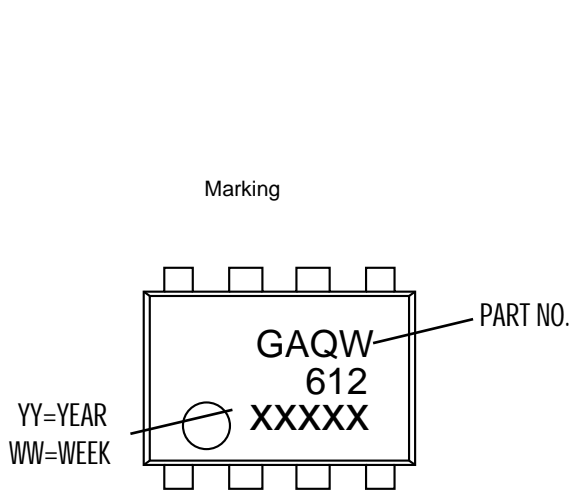

### Surface mount terminal type

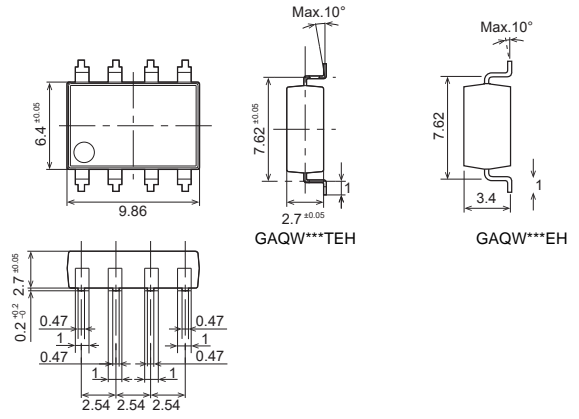

### Recommended mounting pad (Top view)

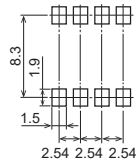

## Tape dimensions ( tape reel )

### Tape dimensions (Unit: mm)

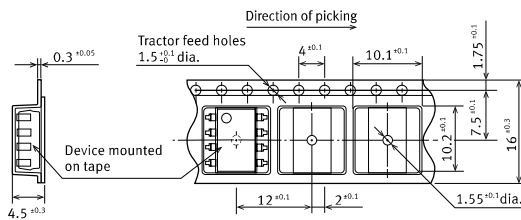

### Dimensions of paper tape reel (Unit: mm)

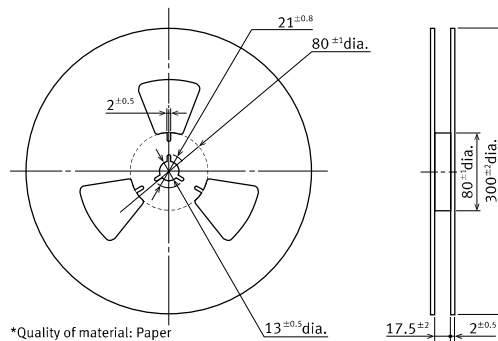

## Using Methods

Examples of resistance value to control LED forward current ( $I_F=5\text{mA}$ )

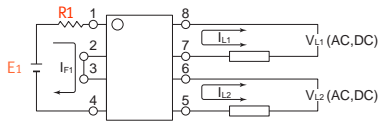

E1	R1 (Approx)
3.3V	300 $\Omega$
5.0V	600 $\Omega$
12V	1.9K $\Omega$
24V	4.1K $\Omega$

LED forward current must be more than 5mA , at I(MIN) , and less than 30mA , at I(MAX).

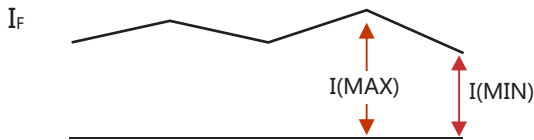

## Recommended Operating Conditions

Please obey the following conditions to ensure proper device operation and resetting. Input LED current (Recommended value):

Characteristic	Symbol	Min	Typ.	Max	Unit
Forward current	$I_F$	5.0	7.0	30	mA

## Protection Circuit

Output spike voltages:if an inductive load generates spike voltages which exceed heabsolute maximum rating, the spike voltage shall be limited.

Clamp diode is connected in parallel with the load.  
Absorb capacity with external diode.

CR Snubber is connected in parallel with the load.  
Absorb capacity with buffer capacity.

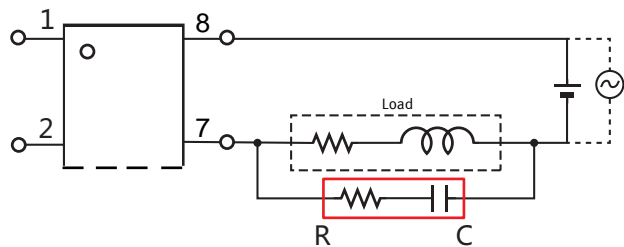
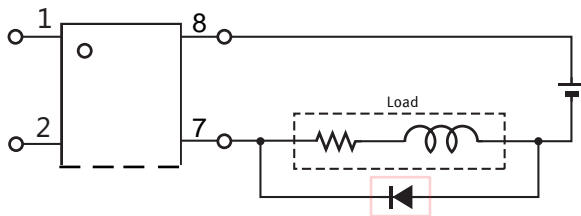

When adding diodes, buffer circuits (C-R), and other protections, they need to be installed near the MOS RELAY to be effective.  
Adding protection elements may result in a slow reset time, so adjust them according to the actual situation before use.

Note: When developing designs using this product, perform the expected performance of the equipment under the operating conditions recommended by the guidelines in this document. Continuous use under heavy loads (including, but not limited to, the application of high temperatures/current/voltage and significant changes in temperature, etc.) may result in deterioration of the reliability of this product.

单击下面可查看定价，库存，交付和生命周期等信息

[>>SUPSiC\(国晶微\)](#)