

Features

- 650-Volt Schottky Rectifier
- Zero Reverse Recovery Current
- Zero Forward Recovery Voltage
- High-Frequency Operation
- Temperature-Independent Switching Behavior
- Extremely Fast Switching
- Positive Temperature Coefficient on V_F

Benefits

- Replace Bipolar with Unipolar Rectifiers
- Essentially No Switching Losses
- Higher Efficiency
- Reduction of Heat Sink Requirements
- Parallel Devices Without Thermal Runaway

Applications

- Switch Mode Power Supplies
- Power Factor Correction
- Motor Drives

Part Number	Package	Marking
GC3D10065A	TO-220-2	GC3D10065

V_{RRM}	=	650 V
$I_F (T_c=135^\circ\text{C})$	=	14.5 A
Q_c	=	24 nC



TO-220-2

Package



Maximum Ratings ($T_c = 25^\circ\text{C}$ unless otherwise specified)

Symbol	Parameter	Value	Unit	Test Conditions	Note
V_{RRM}	Repetitive Peak Reverse Voltage	650	V		
V_{RSM}	Surge Peak Reverse Voltage	650	V		
V_{DC}	DC Blocking Voltage	650	V		
I_F	Continuous Forward Current	30 14.5 10	A	$T_c=25^\circ\text{C}$ $T_c=135^\circ\text{C}$ $T_c=153^\circ\text{C}$	Fig. 3
I_{FRM}	Repetitive Peak Forward Surge Current	46 31	A	$T_c=25^\circ\text{C}, t_p = 10 \text{ ms}$, Half Sine Wave $T_c=110^\circ\text{C}, t_p = 10 \text{ ms}$, Half Sine Wave	
I_{FSM}	Non-Repetitive Peak Forward Surge Current	90 71	A	$T_c=25^\circ\text{C}, t_p = 10 \text{ ms}$, Half Sine Wave $T_c=110^\circ\text{C}, t_p = 10 \text{ ms}$, Half Sine Wave	Fig. 8
I_{FMax}	Non-Repetitive Peak Forward Surge Current	860 680	A	$T_c=25^\circ\text{C}, t_p = 10 \mu\text{s}$, Pulse $T_c=110^\circ\text{C}, t_p = 10 \mu\text{s}$, Pulse	Fig. 8
P_{tot}	Power Dissipation	136.5 59	W	$T_c=25^\circ\text{C}$ $T_c=110^\circ\text{C}$	Fig. 4
T_J, T_{stg}	Operating Junction and Storage Temperature	-55 to +175	$^\circ\text{C}$		
	TO-220 Mounting Torque	1 8.8	Nm lbf-in	M3 Screw 6-32 Screw	

Electrical Characteristics

Symbol	Parameter	Typ.	Max.	Unit	Test Conditions	Note
V_F	Forward Voltage	1.5 2.0	1.8 2.4	V	$I_F = 10\text{ A}$, $T_J = 25^\circ\text{C}$ $I_F = 10\text{ A}$, $T_J = 175^\circ\text{C}$	Fig. 1
I_R	Reverse Current	12 24	60 220	μA	$V_R = 650\text{ V}$, $T_J = 25^\circ\text{C}$ $V_R = 650\text{ V}$, $T_J = 175^\circ\text{C}$	Fig. 2
Q_C	Total Capacitive Charge	24		nC	$V_R = 400\text{ V}$, $I_F = 10\text{ A}$ $di/dt = 500\text{ A}/\mu\text{s}$ $T_J = 25^\circ\text{C}$	Fig. 5
C	Total Capacitance	460.5 44 40		pF	$V_R = 0\text{ V}$, $T_J = 25^\circ\text{C}$, $f = 1\text{ MHz}$ $V_R = 200\text{ V}$, $T_J = 25^\circ\text{C}$, $f = 1\text{ MHz}$ $V_R = 400\text{ V}$, $T_J = 25^\circ\text{C}$, $f = 1\text{ MHz}$	Fig. 6
E_C	Capacitance Stored Energy	3.6		μJ	$V_R = 400\text{ V}$	Fig. 7

Note: This is a majority carrier diode, so there is no reverse recovery charge.

Thermal Characteristics

Symbol	Parameter	Typ.	Unit	Note
$R_{\theta JC}$	Thermal Resistance from Junction to Case	1.1	$^\circ\text{C}/\text{W}$	Fig. 9

Typical Performance

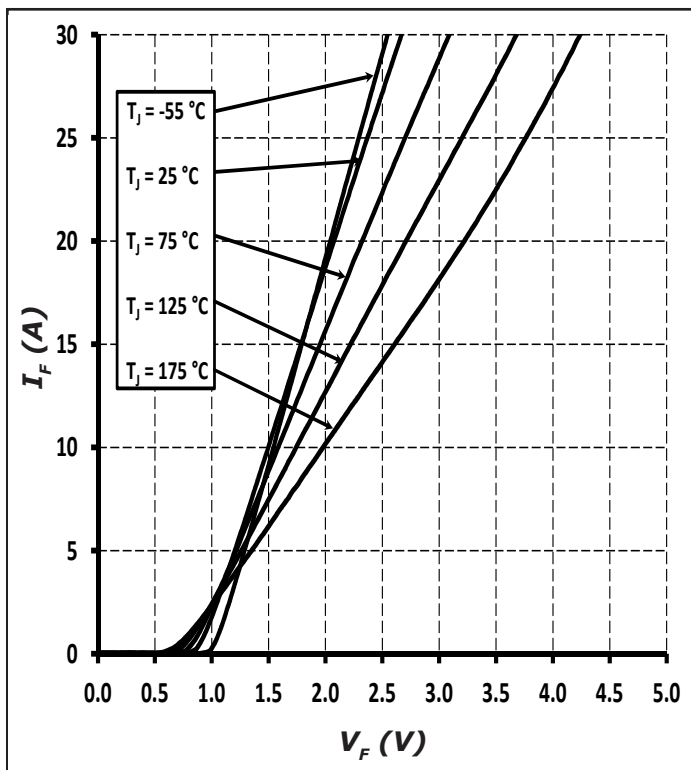

Figure 1. Forward Characteristics

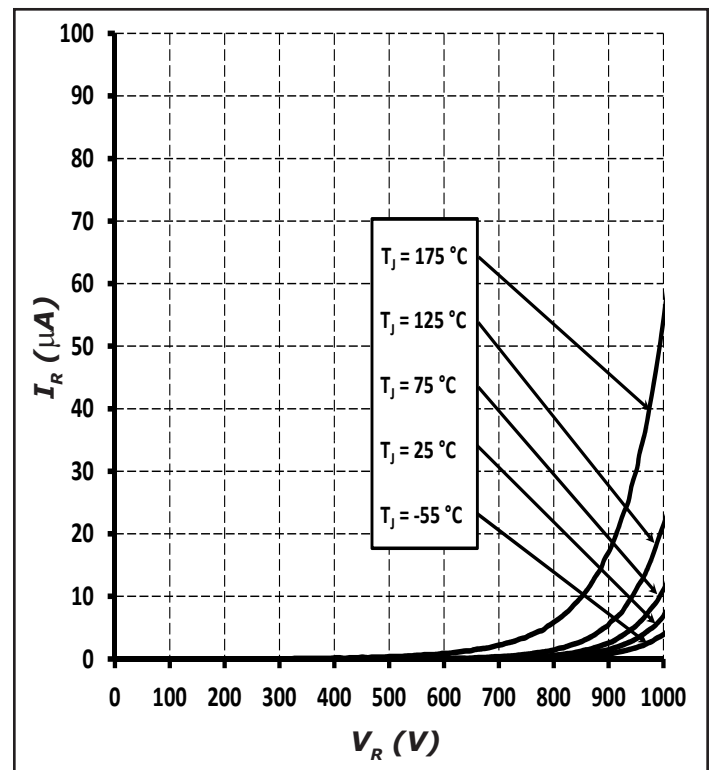

Figure 2. Reverse Characteristics

Typical Performance

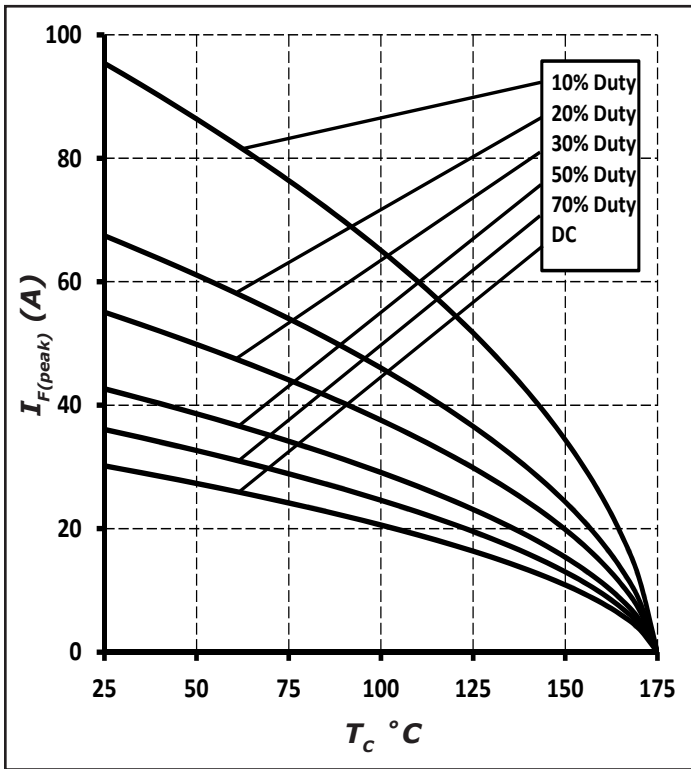

Figure 3. Current Derating

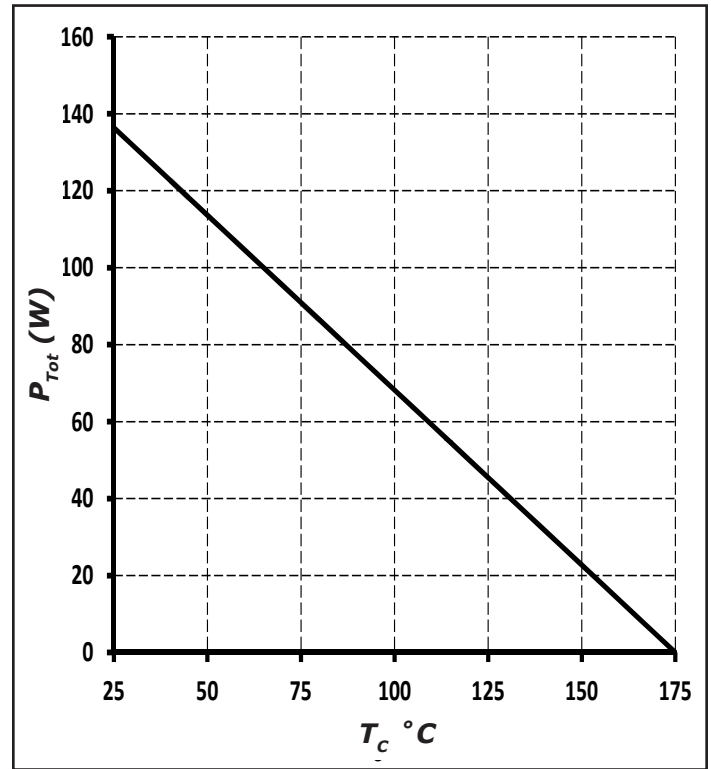

Figure 4. Power Derating

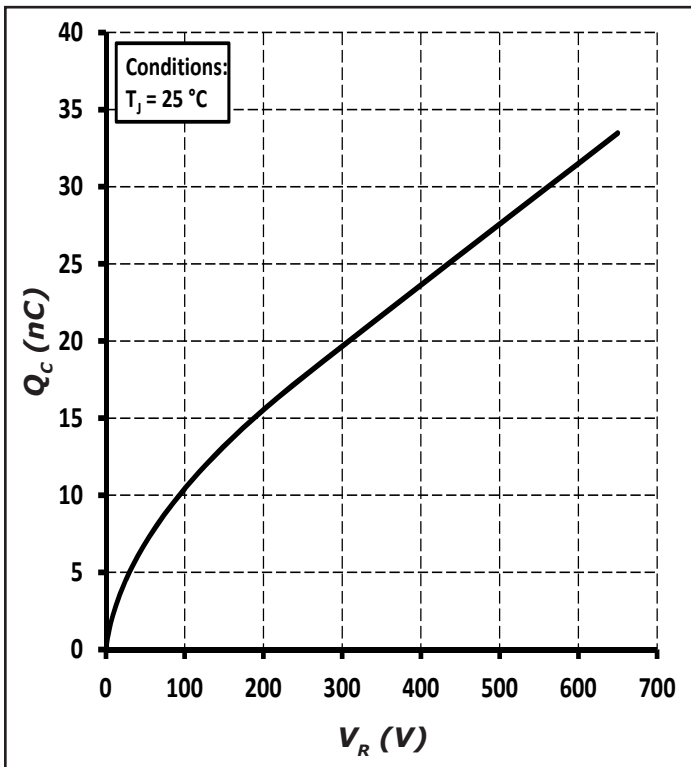

Figure 5. Total Capacitance Charge vs. Reverse Voltage

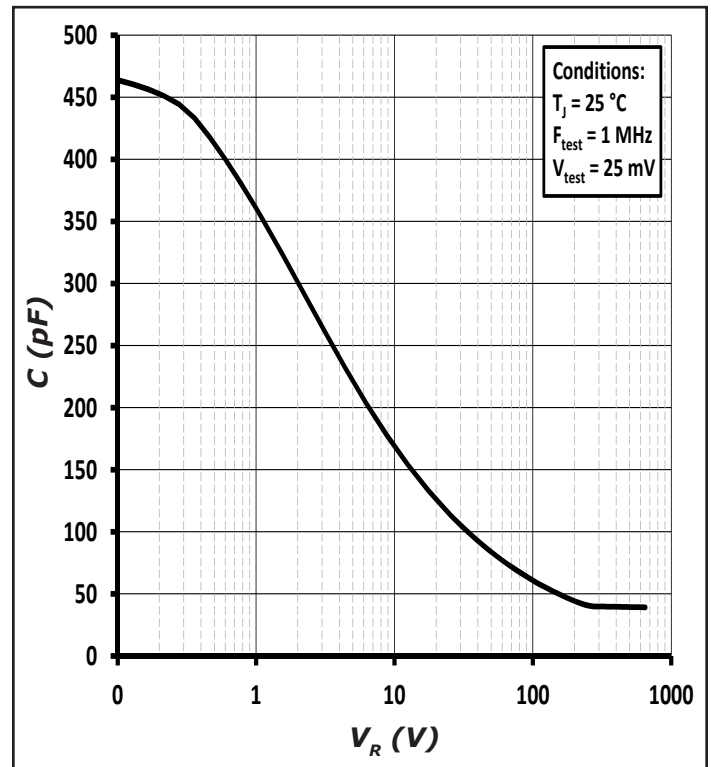

Figure 6. Capacitance vs. Reverse Voltage

Typical Performance

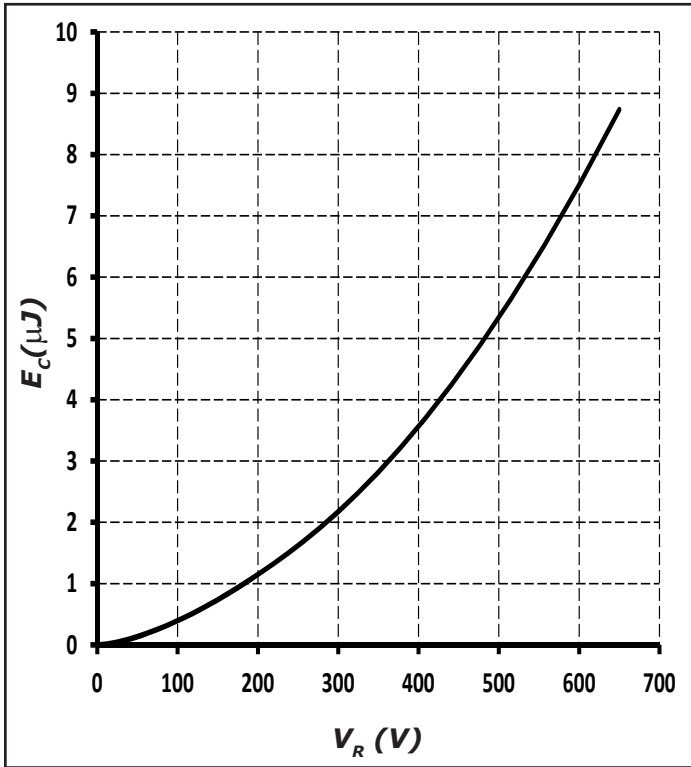

Figure 7. Capacitance Stored Energy

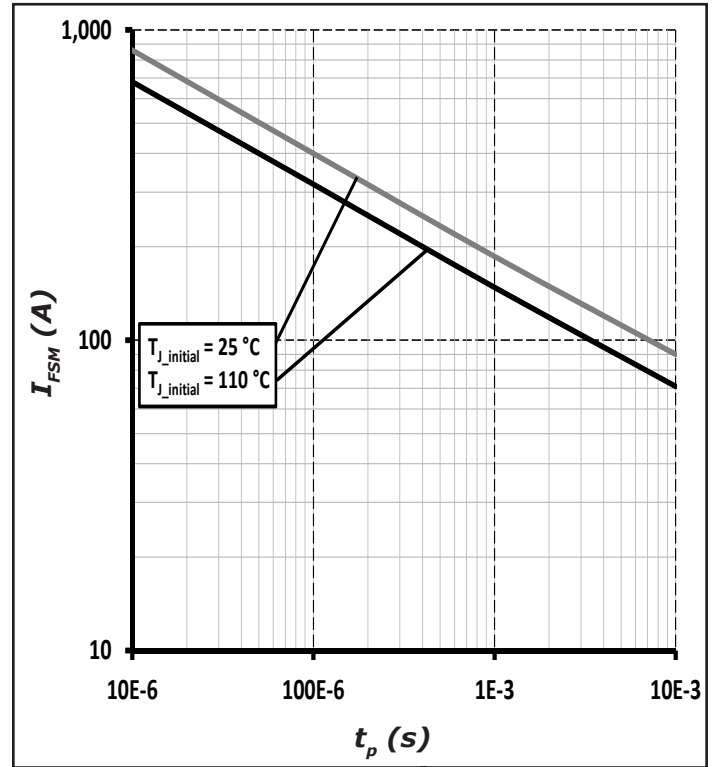

Figure 8. Non-repetitive peak forward surge current versus pulse duration (sinusoidal waveform)

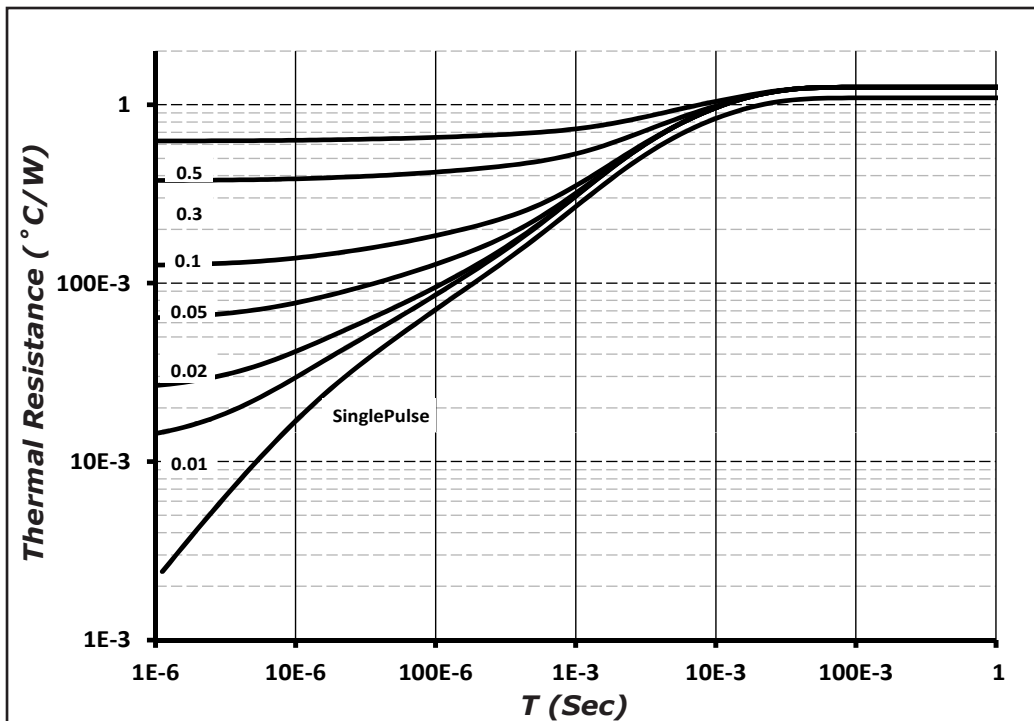
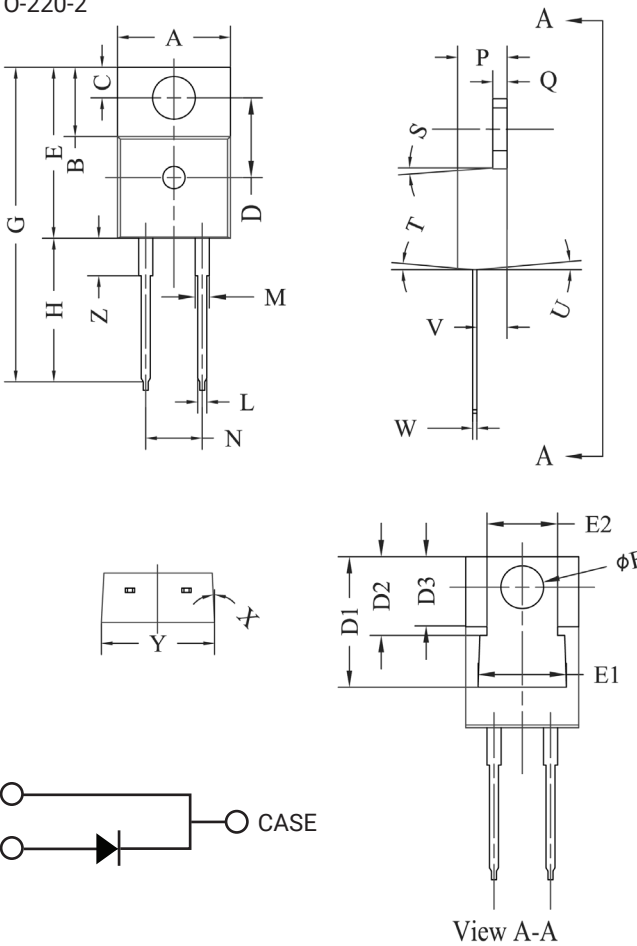

Figure 9. Transient Thermal Impedance

Package Dimensions

Package TO-220-2



POS	Inches		Millimeters	
	Min	Max	Min	Max
A	.381	.410	9.677	10.414
B	.235	.255	5.969	6.477
C	.100	.120	2.540	3.048
D	.223	.337	5.664	8.560
D1	.457-.490		11.60-12.45 typ	
D2	.277-.303 typ		7.04-7.70 typ	
D3	.244-.252 typ		6.22-6.4 typ	
E	.590	.615	14.986	15.621
E1	.302	.326	7.68	8.28
E2	.227	.251	5.77	6.37
F	.143	.153	3.632	3.886
G	1.105	1.147	28.067	29.134
H	.500	.550	12.700	13.970
L	.025	.036	.635	.914
M	.045	.055	1.143	1.550
N	.195	.205	4.953	5.207
P	.165	.185	4.191	4.699
Q	.048	.054	1.219	1.372
S	3°	6°	3°	6°
T	3°	6°	3°	6°
U	3°	6°	3°	6°
V	.094	.110	2.388	2.794
W	.014	.025	.356	.635
X	3°	5.5°	3°	5.5°
Y	.385	.410	9.779	10.414
Z	.130	.150	3.302	3.810

NOTE:

1. Dimension L, M, W apply for Solder Dip Finish

Recommended Solder Pad Layout

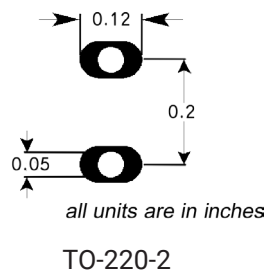

Part Number	Package
GC3D10065A	TO-220-2

Diode Model

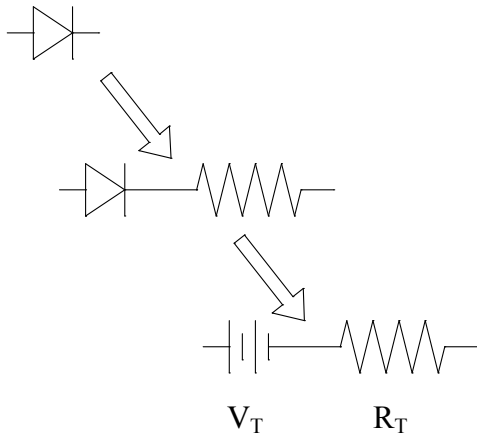

$$V_f = V_T + I_f * R_T$$

$$V_T = 0.94 + (T_J * -1.3 * 10^{-3})$$

$$R_T = 0.044 + (T_J * 4.4 * 10^{-4})$$

Note: T_J = Diode Junction Temperature In Degrees Celsius,
valid from 25°C to 175°C

单击下面可查看定价，库存，交付和生命周期等信息

[>>SUPSiC\(国晶微\)](#)