



Features

- Low driver power requirements (TTL/CMOS Compatible)
- No moving parts
- High reliability
- Arc-Free with no snubbing circuits
- 3750Vrms Input/Output isolation

Applications

- Telecommunications (PC, Electronic notepad)
- Measuring and Testing equipment
- Industrial control
- Security equipments
- High speed inspection machine

Outline Dimensions

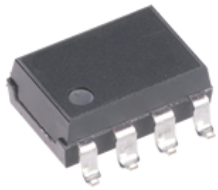

SMD-8



DIP-8

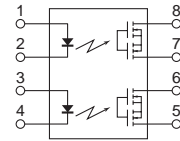

1,3. LED Anode
2,4. LED Cathode
5,6. Drain (MOS FET)
7,8. Drain (MOS FET)

TYPES

Category	Output rating		Package	Part No.	Packing quantity
	Load voltage	Load current			
AC/DC	60V	2A	DIP8	GAQW212G2E	50pcs/tube
			SMD8	GAQW212G2EH	1000pcs/reel

Absolute Maximum Ratings (Ambient Temperature: 25 °C)

Item		Symbol	Value	Units	Note
Input	Continuous LED Current	I_F	50	mA	
	Peak LED Current	I_{FP}	1000	mA	f=100Hz, duty=1%
	LED Reverse Voltage	V_R	5	V	
	Input Power Dissipation	P_{in}	75	mW	
Output	Load Voltage	V_L	60	V(AC peak or DC)	
	Load Current	I_L	2.0	A	
	Peak Load Current	I_{Peak}	6.0	A	100ms(1 pulse)
	Output Power Dissipation	P_{out}	500	mW	
Total Power Dissipation		P_T	650	mW	
I/O Breakdown Voltage		$V_{I/O}$	3750	V _{rm}	RH=60%, 1min
Operating Temperature		T_{opr}	-40 to +85	°C	
Storage Temperature		T_{stg}	-40 to +100	°C	
Pin Soldering Temperature		T_{sol}	260	°C	10 sec max.

Electrical Specifications (Ambient Temperature: 25 °C)

Item		Symbol	MIN.	TYP.	MAX.	Units	Conditions
Input	LED Forward Voltage	V_F	1.2	1.32	1.6	V	$I_F=10mA$
	Operation LED Current	$I_{F on}$		1.0	5.0	mA	
	Recovery LED Current	$I_{F off}$		0.35	0.5	mA	
	Recovery LED Voltage	$V_{F off}$	0.7			V	
Output	On-Resistance	R_{on}		0.069	0.085	Ω	$I_F=5mA, I_L=2Amp$ Within 1s on time
	Off-State Leakage Current	I_{Leak}			0.01	μA	$I_F=0mA, V_L=50V$
	Output Capacitance	C_{out}		115		pF	$f=1MHz$
Transmission	Turn-On Time	T_{on}	1.0	2.7	3.2	ms	$I_F=5mA, I_L=2A$
	Turn-Off Time	T_{off}	0.04	0.05	0.1	ms	
Coupled	I/O Isolation Resistance	$R_{I/O}$	5			G Ω	DC=500V
	I/O Capacitance	$C_{I/O}$		0.8	1.5	pF	$f=1MHz$

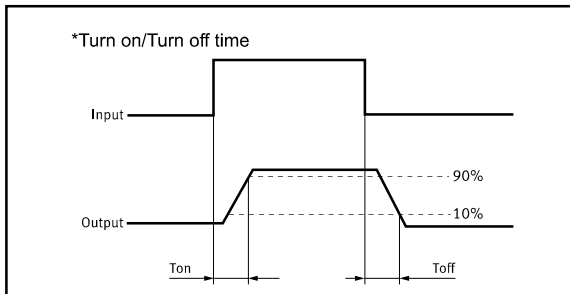

Please obey the following conditions to ensure proper device operation and resetting. Input LED current (Recommended value): $I_F \geq 5mA$ and $\leq 30mA$.
 Examples of resistance value to control LED forward current ($I_F=5mA, INPUT VOLTAGE="E", RESISTORS="R"$)
 "E"=3.3V,"R"=330 Ω ; "E"=5V,"R"=640 Ω ; "E"=12V,"R"=1.9K Ω ; "E"=15V,"R"=2.5K Ω ; "E"=24V,"R"=4.1K Ω ;

Reference Data

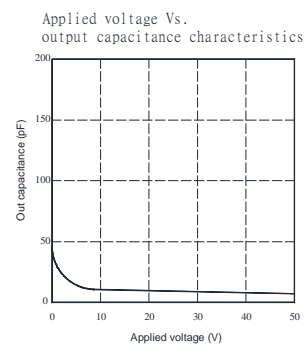
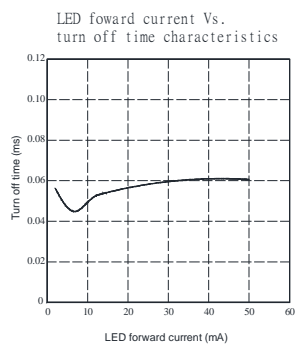
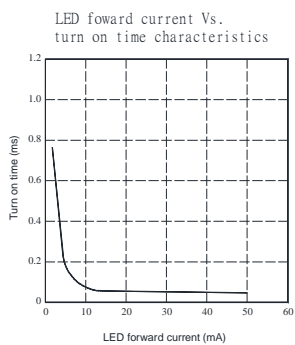
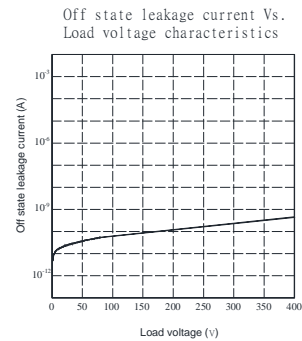
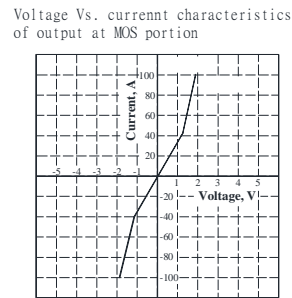
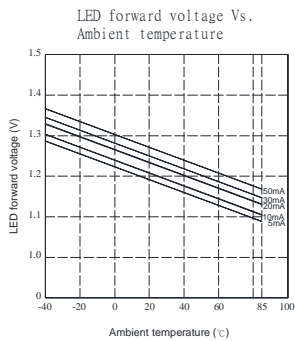
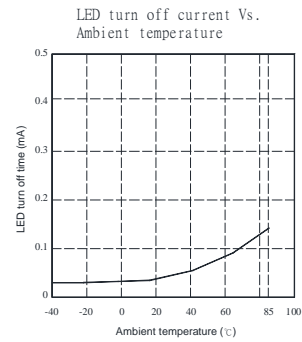
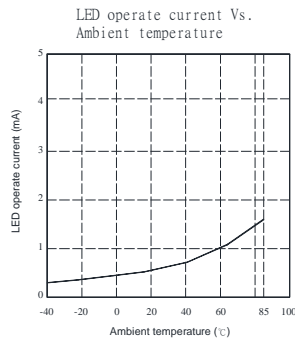
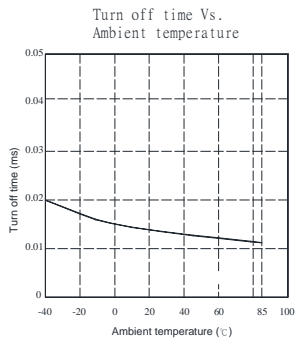
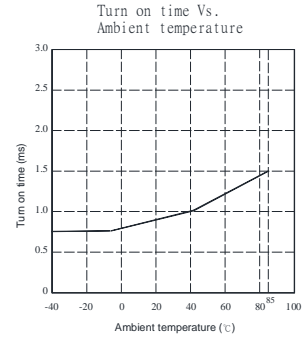
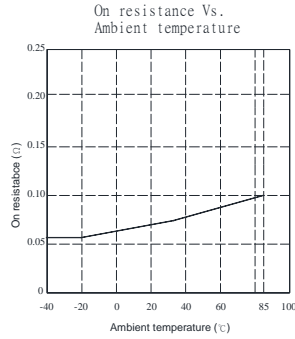
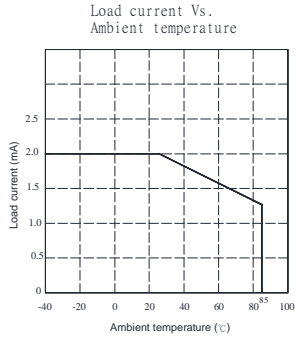

8-DIP

Dimensions

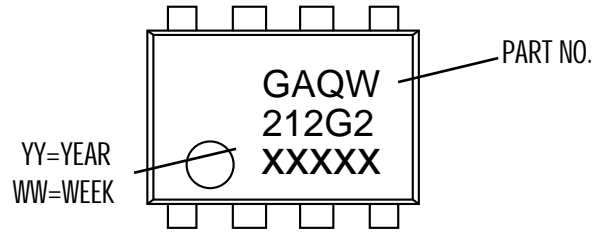

Through hole terminal type

PC board pattern

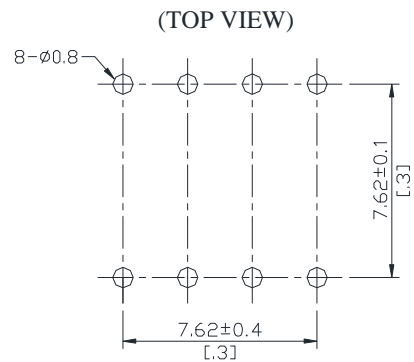
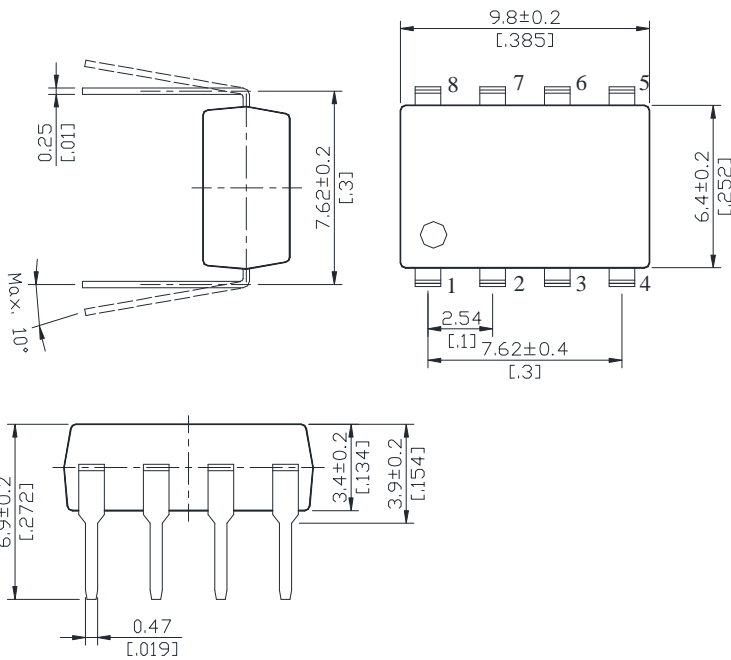

Unit : mm inch
Tolerance : +0.2 +.007

DIP type

Devices are packaged in a tube so that pin No. 1 is on the stopper B side. Observe correct orientation when mounting them on PC boards.

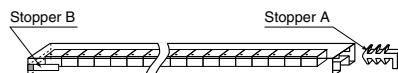

8-SMD

Dimensions

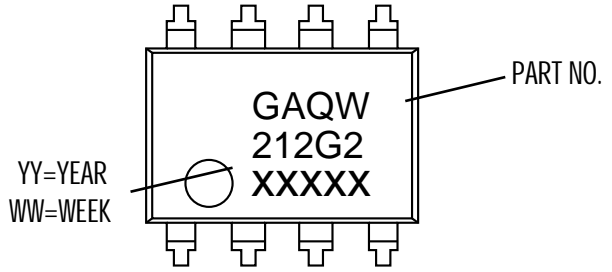

Surface mount terminal type

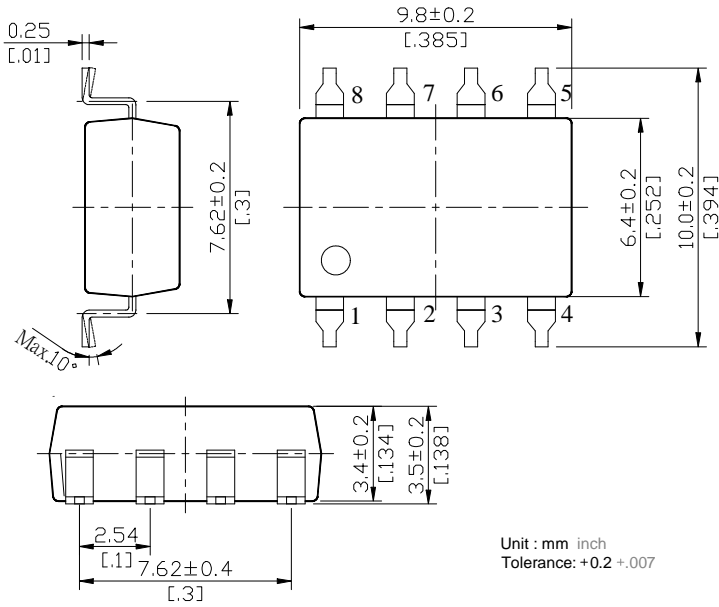

PC board pattern

(Top view)

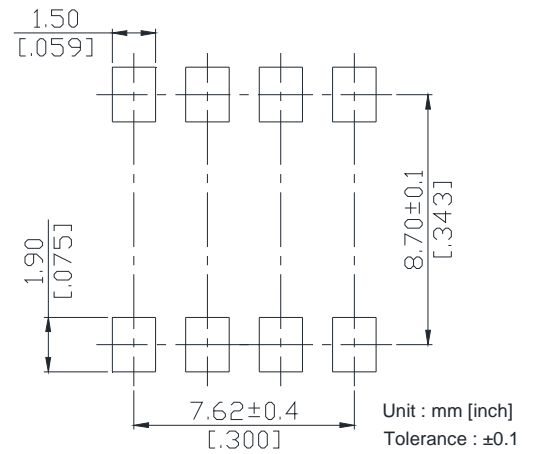

Tape dimensions

Direction of feed

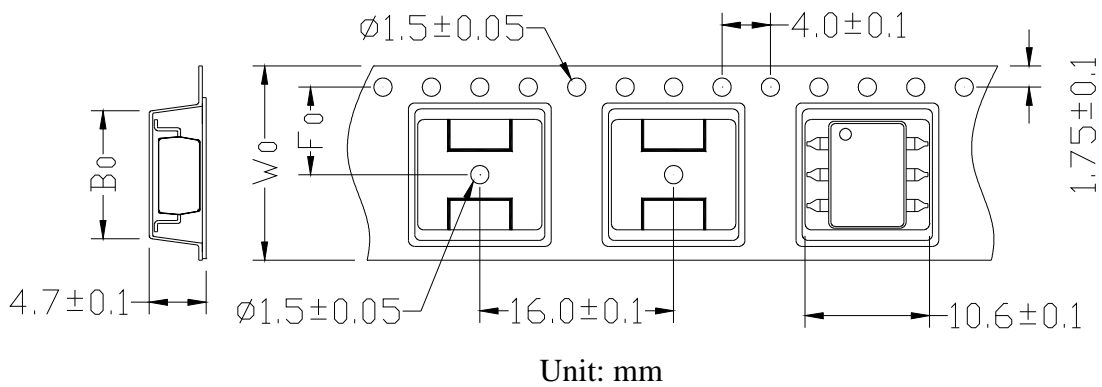

Dimensions of tape reel

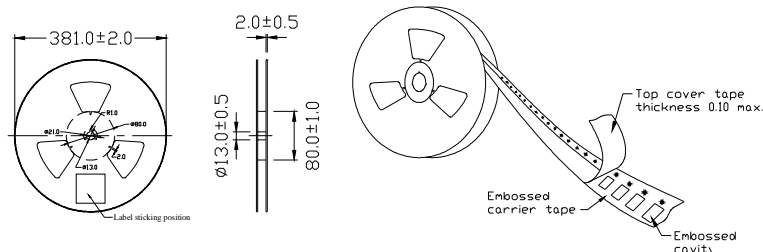

单击下面可查看定价，库存，交付和生命周期等信息

[>>SUPSiC\(国晶微\)](#)