

## Features

- 1.2-KVolt Schottky Rectifier
- Zero Reverse Recovery Current
- High-Frequency Operation
- Temperature-Independent Switching Behavior
- Positive Temperature Coefficient on  $V_F$

## Benefits

- Replace Bipolar with Unipolar Rectifiers
- Essentially No Switching Losses
- Higher Efficiency
- Reduction of Heat Sink Requirements
- Parallel Devices Without Thermal Runaway

## Applications

- Switch Mode Power Supplies (SMPS)
- Boost diodes in PFC or DC/DC stages
- Free Wheeling Diodes in Inverter stages
- AC/DC converters

Part Number	Package	Marking
GC4D20120D	TO-247-3	GC4D20120

$$V_{RRM} = 1200 \text{ V}$$

$$I_F (T_c=135^\circ\text{C}) = 33 \text{ A}^{**}$$

$$Q_c = 104 \text{ nC}^{**}$$

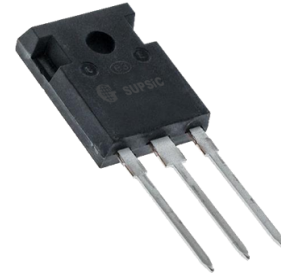

TO-247-3

## Package

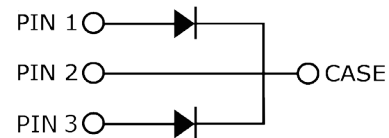

## Maximum Ratings ( $T_c=25^\circ\text{C}$ unless otherwise specified)

Symbol	Parameter	Value	Unit	Test Conditions	Note
$V_{RRM}$	Repetitive Peak Reverse Voltage	1200	V		
$V_{RSM}$	Surge Peak Reverse Voltage	1300	V		
$V_{DC}$	DC Blocking Voltage	1200	V		
$I_F$	Continuous Forward Current (Per Leg/Device)	34/68 16.5/33 10/20	A	$T_c=25^\circ\text{C}$ $T_c=135^\circ\text{C}$ $T_c=157^\circ\text{C}$	Fig. 3
$I_{FRM}$	Repetitive Peak Forward Surge Current	47* 31.5*	A	$T_c=25^\circ\text{C}$ , $t_p=10$ ms, Half Sine Pulse $T_c=110^\circ\text{C}$ , $t_p=10$ ms, Half Sine Pulse	
$I_{FSM}$	Non-Repetitive Peak Forward Surge Current	71* 59.5*	A	$T_c=25^\circ\text{C}$ , $t_p=10$ ms, Half Sine Pulse $T_c=110^\circ\text{C}$ , $t_p=10$ ms, Half Sine Pulse	Fig. 8
$I_{F,Max}$	Non-Repetitive Peak Forward Current	750* 620*	A	$T_c=25^\circ\text{C}$ , $t_p=10$ $\mu\text{s}$ , Pulse $T_c=110^\circ\text{C}$ , $t_p=10$ $\mu\text{s}$ , Pulse	Fig. 8
$P_{tot}$	Power Dissipation(Per Leg/Device)	176/352 76/152	W	$T_c=25^\circ\text{C}$ $T_c=110^\circ\text{C}$	Fig. 4
dV/dt	Diode dV/dt ruggedness	200	V/ns	$V_R=0-960\text{V}$	
$\int i^2 dt$	$i^2t$ value	25* 17.5*	A <sup>2</sup> s	$T_c=25^\circ\text{C}$ , $t_p=10$ ms $T_c=110^\circ\text{C}$ , $t_p=10$ ms	
$T_j$	Operating Junction Range	-55 to +175	$^\circ\text{C}$		
$T_{stg}$	Storage Temperature Range	-55 to +135	$^\circ\text{C}$		
	TO-247 Mounting Torque	1 8.8	Nm lbf-in	M3 Screw 6-32 Screw	

### Electrical Characteristics (Per Leg)

Symbol	Parameter	Typ.	Max.	Unit	Test Conditions	Note
$V_F$	Forward Voltage	1.5 2.2	1.8 3	V	$I_F = 10\text{ A}$ , $T_J = 25^\circ\text{C}$ $I_F = 10\text{ A}$ , $T_J = 175^\circ\text{C}$	Fig. 1
$I_R$	Reverse Current	30 55	250 350	$\mu\text{A}$	$V_R = 1200\text{ V}$ , $T_J = 25^\circ\text{C}$ $V_R = 1200\text{ V}$ , $T_J = 175^\circ\text{C}$	Fig. 2
$Q_C$	Total Capacitive Charge	52		nC	$V_R = 800\text{ V}$ , $I_F = 10\text{ A}$ $di/dt = 200\text{ A}/\mu\text{s}$ $T_J = 25^\circ\text{C}$	Fig. 5
C	Total Capacitance	754 45 38		pF	$V_R = 0\text{ V}$ , $T_J = 25^\circ\text{C}$ , $f = 1\text{ MHz}$ $V_R = 400\text{ V}$ , $T_J = 25^\circ\text{C}$ , $f = 1\text{ MHz}$ $V_R = 800\text{ V}$ , $T_J = 25^\circ\text{C}$ , $f = 1\text{ MHz}$	Fig. 6
$E_C$	Capacitance Stored Energy	14.5		$\mu\text{J}$	$V_R = 800\text{ V}$	Fig. 7

Note: This is a majority carrier diode, so there is no reverse recovery charge.

### Thermal Characteristics

Symbol	Parameter	Typ.	Unit	Note
$R_{\theta JC}$	Thermal Resistance from Junction to Case	0.85* 0.43**	$^\circ\text{C}/\text{W}$	Fig. 9

\* Per Leg, \*\* Per Device

### Typical Performance (Per Leg)

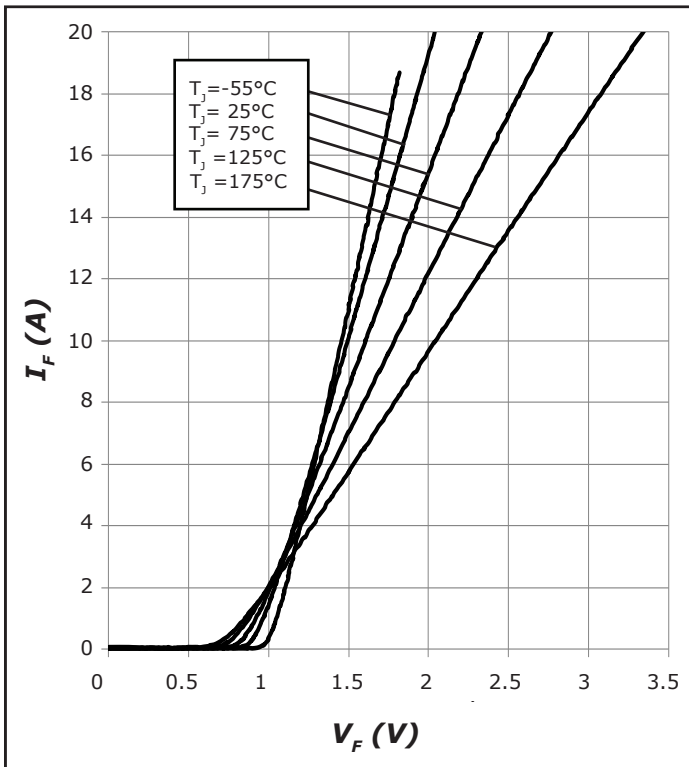

Figure 1. Forward Characteristics

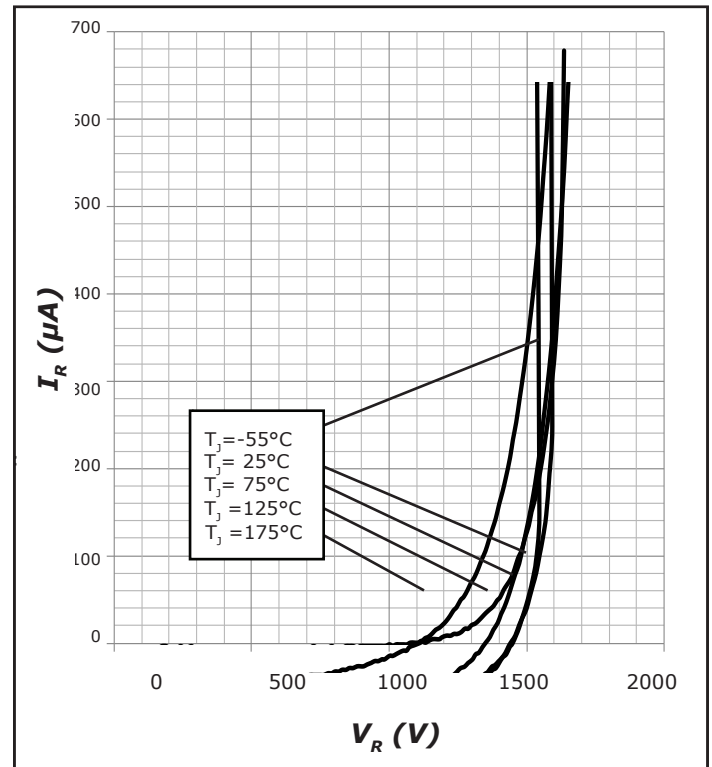

Figure 2. Reverse Characteristics

Typical Performance (Per Leg)

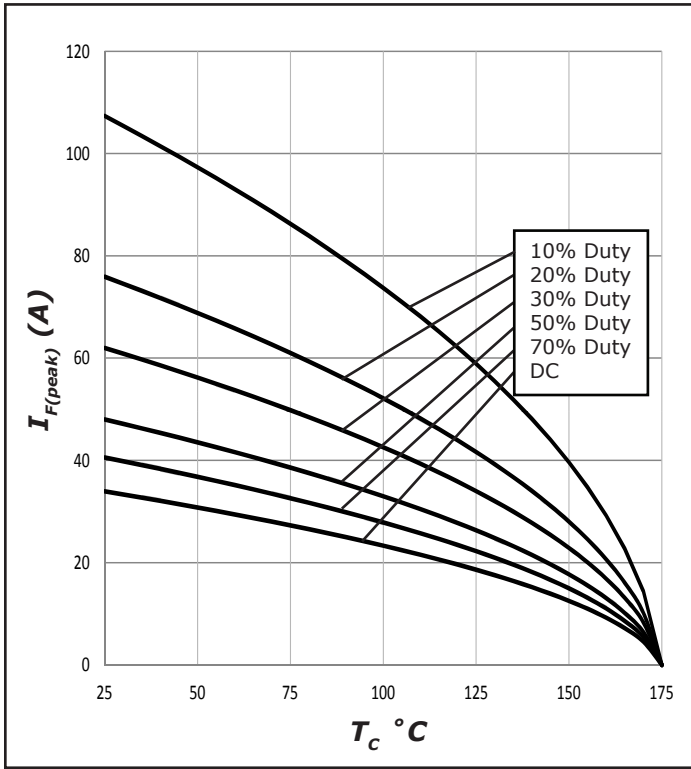

Figure 3. Current Derating

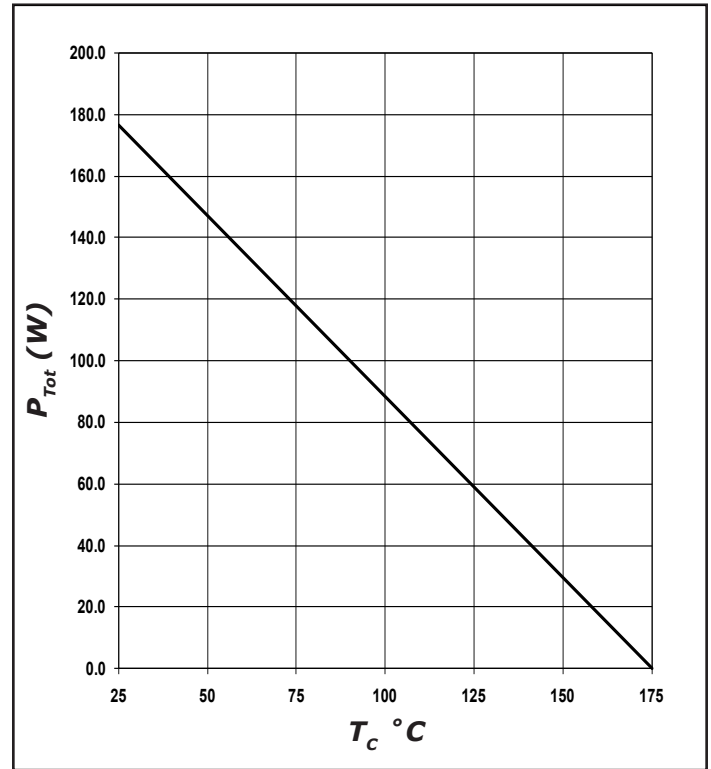

Figure 4. Power Derating

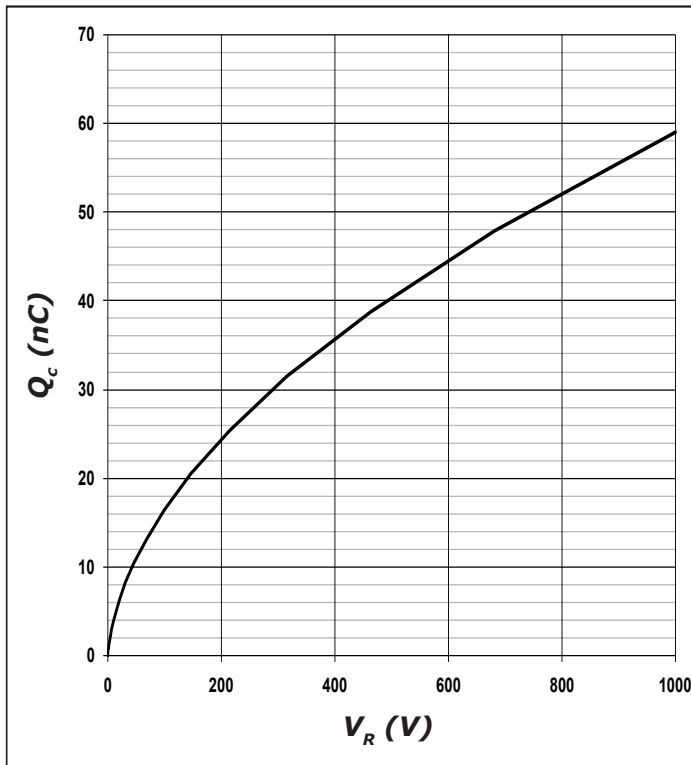

Figure 5. Recovery Charge vs. Reverse Voltage

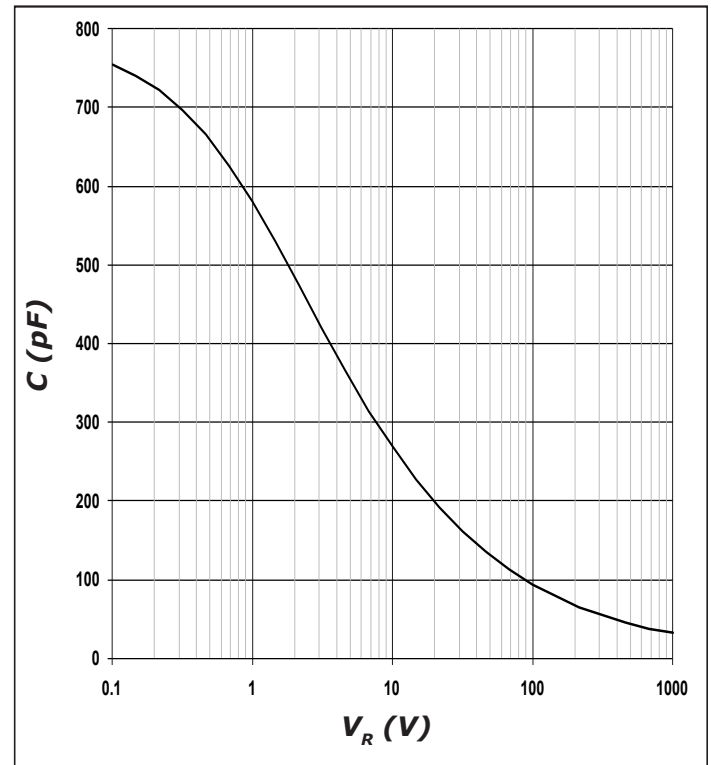

Figure 6. Capacitance vs. Reverse Voltage

Typical Performance

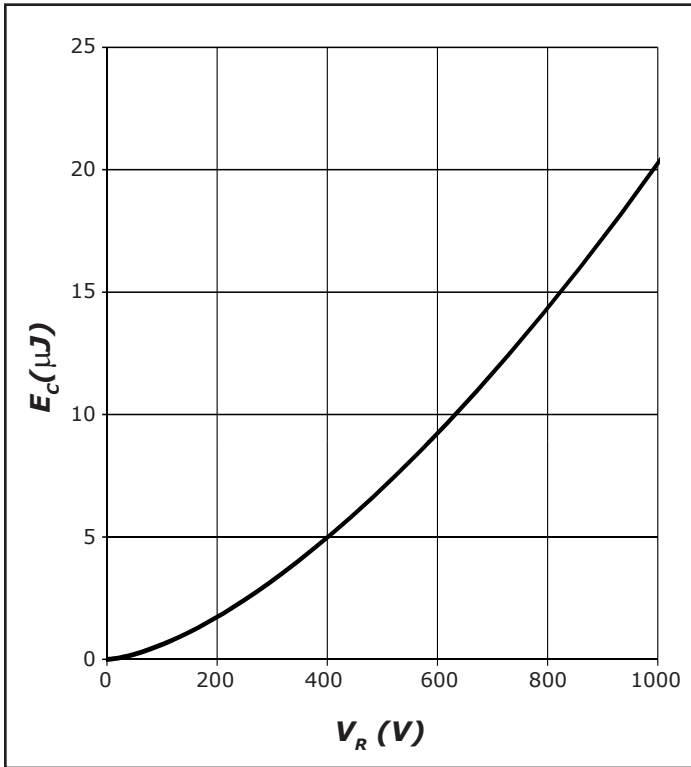

Figure 7. Typical Capacitance Stored Energy, per leg

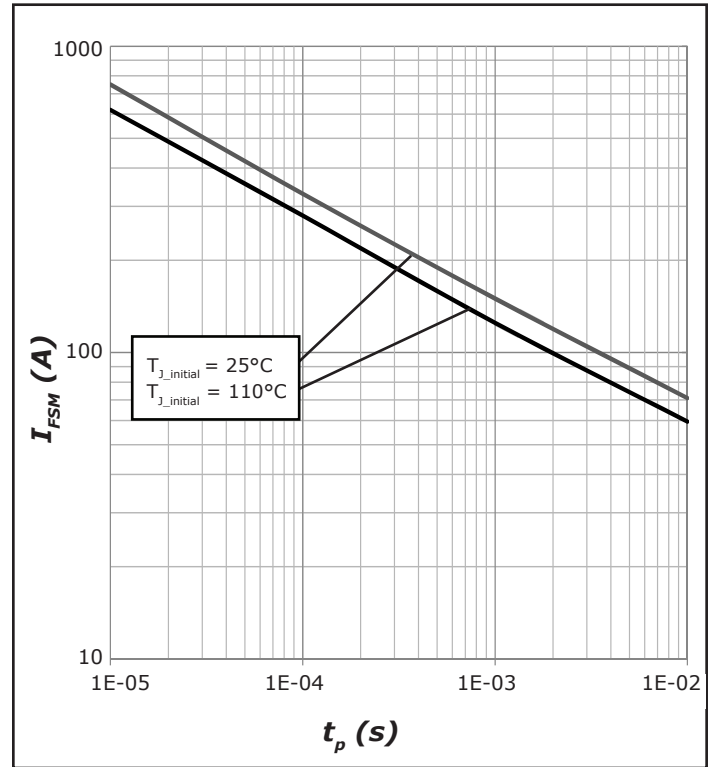

Figure 8. Non-Repetitive Peak Forward Surge Current versus Pulse Duration (sinusoidal waveform), per leg

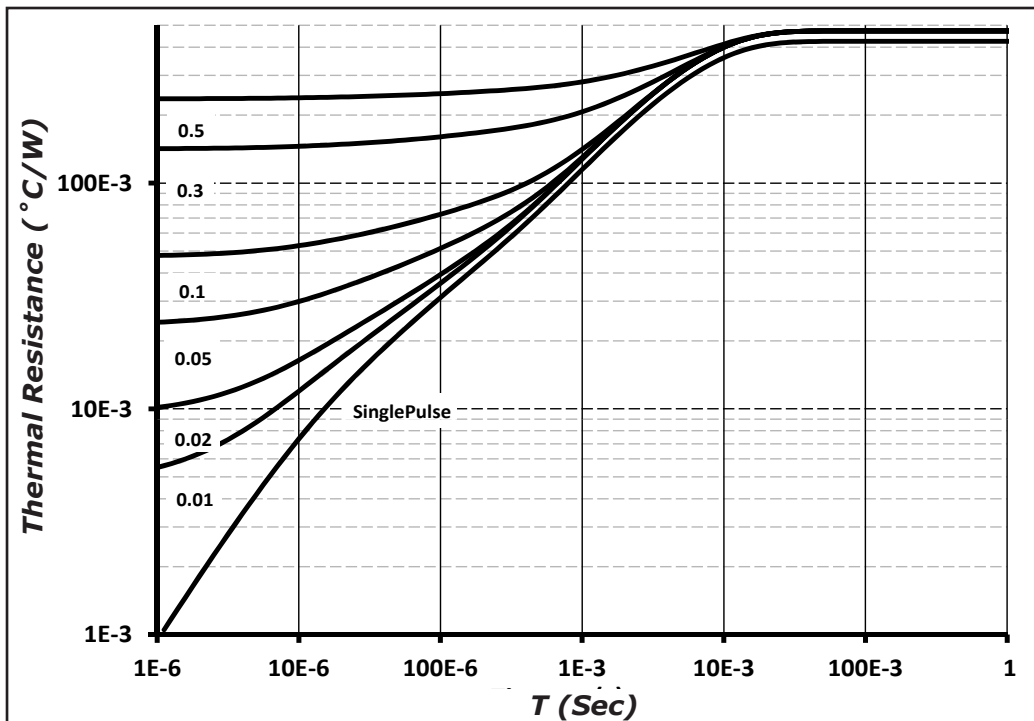
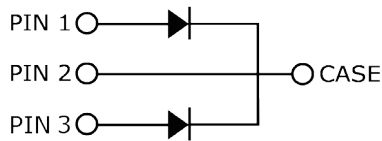
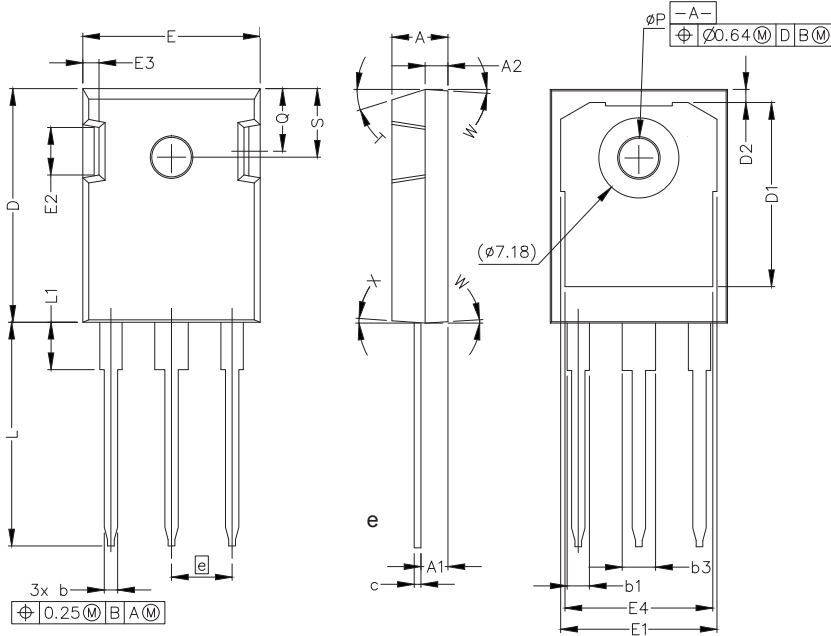

Figure 9. Device Transient Thermal Impedance

### Package Dimensions

Package TO-247-3



POS	Inches		Millimeters	
	Min	Max	Min	Max
A	.190	.205	4.83	5.21
A1	.090	.100	2.29	2.54
A2	.075	.085	1.91	2.16
b	.042	.052	1.07	1.33
b1	.075	.095	1.91	2.41
b3	.113	.133	2.87	3.38
c	.022	.027	0.55	0.68
D	.819	.831	20.80	21.10
D1	.640	.695	16.25	17.65
D2	.037	.049	0.95	1.25
E	.620	.635	15.75	16.13
E1	.516	.557	13.10	14.15
E2	.145	.201	3.68	5.10
E3	.039	.075	1.00	1.90
E4	.487	.529	12.38	13.43
e	.214 BSC		5.44 BSC	
L	.780	.800	19.81	20.32
L1	.161	.173	4.10	4.40
N	3			
ØP	.138	.144	3.51	3.65
Q	.216	.236	5.49	6.00
S	.238	.248	6.04	6.30
T	17.5° REF			
W	3.5° REF			
X	4° REF			

### Recommended Solder Pad Layout

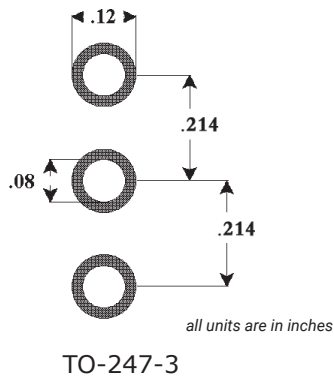

Part Number	Package
GC4D20120D	TO-247-3

**Diode Model**

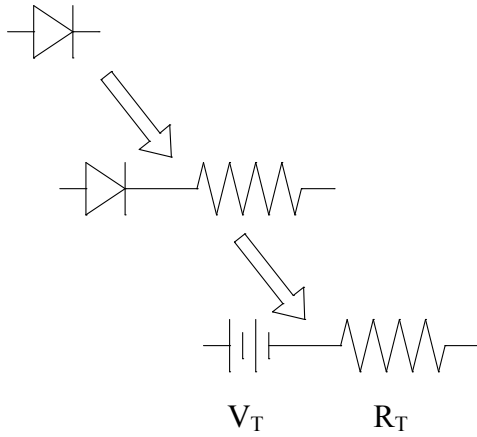

$$V_{fT} = V_T + I_f * R_T$$

$$V_T = 0.98 + (T_j * -1.71 * 10^{-3})$$

$$R_T = 0.040 + (T_j * 5.32 * 10^{-4})$$

**Note:**  $T_j$  = Diode Junction Temperature In Degrees Celsius, valid from 25°C to 175°C

单击下面可查看定价，库存，交付和生命周期等信息

[>>SUPSiC\(国晶微\)](#)