



Features

- Optimized package with separate driver source pin
- High blocking voltage with low on-resistance
- High-speed switching with low capacitances
- Fast intrinsic diode with low reverse recovery (Q_{rr})
- Halogen free, RoHS compliant

Benefits

- Reduce switching losses and minimize gate ringing
- Higher system efficiency
- Reduce cooling requirements
- Increase power density
- Increase system switching frequency

Applications

- Solar inverters
- EV motor drive
- High voltage DC/DC converters
- Switched mode power supplies
- Load switch

Part Number	Package	Marking
GC3M0032120K	TO-247-4	GC3M0032120

V_{DS}	1200 V
$I_D @ 25^\circ\text{C}$	63 A
$R_{DS(on)}$	32 m Ω



TO-247-4

Package

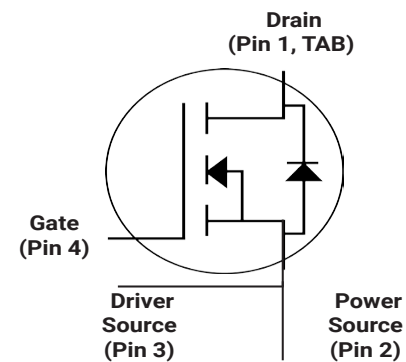

Maximum Ratings ($T_c = 25^\circ\text{C}$ unless otherwise specified)

Symbol	Parameter	Value	Unit	Test Conditions	Note
V_{DSmax}	Drain - Source Voltage	1200	V	$V_{GS} = 0\text{ V}, I_D = 100\ \mu\text{A}$	
V_{GSmax}	Gate - Source Voltage (dynamic)	-8/+19	V	AC ($f > 1\text{ Hz}$)	Note 1
V_{GSop}	Gate - Source Voltage (static)	-4/+15	V	Static	Note 2
I_D	Continuous Drain Current	63	A	$V_{GS} = 15\text{ V}, T_c = 25^\circ\text{C}$	Fig. 19
		48		$V_{GS} = 15\text{ V}, T_c = 100^\circ\text{C}$	
$I_{D(pulse)}$	Pulsed Drain Current	120	A	Pulse width t_p limited by T_{jmax}	
P_D	Power Dissipation	283	W	$T_c = 25^\circ\text{C}, T_j = 175^\circ\text{C}$	Fig. 20
T_j, T_{stg}	Operating Junction and Storage Temperature	-40 to +175	$^\circ\text{C}$		
T_L	Solder Temperature	260	$^\circ\text{C}$	1.6mm (0.063") from case for 10s	

Note (1): When using MOSFET Body Diode $V_{GSmax} = -4\text{V}/+19\text{V}$

Note (2): MOSFET can also safely operate at $0/+15\text{ V}$

Electrical Characteristics ($T_c = 25^\circ\text{C}$ unless otherwise specified)

Symbol	Parameter	Min.	Typ.	Max.	Unit	Test Conditions	Note
$V_{(BR)DSS}$	Drain-Source Breakdown Voltage	1200			V	$V_{GS} = 0\text{ V}, I_D = 100\ \mu\text{A}$	
$V_{GS(th)}$	Gate Threshold Voltage	1.8	2.5	3.6	V	$V_{DS} = V_{GS}, I_D = 11.5\ \text{mA}$	Fig. 11
			2.0		V	$V_{DS} = V_{GS}, I_D = 11.5\ \text{mA}, T_J = 175^\circ\text{C}$	
I_{DSS}	Zero Gate Voltage Drain Current		1	50	μA	$V_{DS} = 1200\ \text{V}, V_{GS} = 0\ \text{V}$	
I_{GSS}	Gate-Source Leakage Current		10	250	nA	$V_{GS} = 15\ \text{V}, V_{DS} = 0\ \text{V}$	
$R_{DS(on)}$	Drain-Source On-State Resistance	23	32	43	m Ω	$V_{GS} = 15\ \text{V}, I_D = 40\ \text{A}$	Fig. 4, 5, 6
			57.6			$V_{GS} = 15\ \text{V}, I_D = 40\ \text{A}, T_J = 175^\circ\text{C}$	
g_{fs}	Transconductance		27		S	$V_{DS} = 20\ \text{V}, I_{DS} = 40\ \text{A}$	Fig. 7
			22			$V_{DS} = 20\ \text{V}, I_{DS} = 40\ \text{A}, T_J = 175^\circ\text{C}$	
C_{iss}	Input Capacitance		3357		pF	$V_{GS} = 0\ \text{V}, V_{DS} = 1000\ \text{V}$ $f = 100\ \text{kHz}$ $V_{AC} = 25\ \text{mV}$	Fig. 17, 18
C_{oss}	Output Capacitance		129				
C_{rss}	Reverse Transfer Capacitance		8				
E_{oss}	C_{oss} Stored Energy		76				μJ
E_{ON}	Turn-On Switching Energy (SiC Diode FWD)		367		μJ	$V_{DS} = 800\ \text{V}, V_{GS} = -4\ \text{V}/+15\ \text{V}, I_D = 40\ \text{A},$ $R_{G(ext)} = 2.5\ \Omega, L = 65.7\ \mu\text{H}, T_J = 175^\circ\text{C}$	Fig. 26
E_{OFF}	Turn Off Switching Energy (SiC Diode FWD)		123				
E_{ON}	Turn-On Switching Energy (Body Diode FWD)		955		μJ	$V_{DS} = 800\ \text{V}, V_{GS} = -4\ \text{V}/+15\ \text{V}, I_D = 40\ \text{A},$ $R_{G(ext)} = 2.5\ \Omega, L = 65.7\ \mu\text{H}, T_J = 175^\circ\text{C}$	Fig. 26
E_{OFF}	Turn Off Switching Energy (Body Diode FWD)		107				
$t_{d(on)}$	Turn-On Delay Time		25		ns	$V_{DD} = 800\ \text{V}, V_{GS} = -4\ \text{V}/15\ \text{V}$ $R_{G(ext)} = 2.5\ \Omega, I_D = 40\ \text{A}, L = 65.7$ Timing relative to V_{DS} , Inductive load	Fig. 27
t_r	Rise Time		18				
$t_{d(off)}$	Turn-Off Delay Time		32				
t_f	Fall Time		9				
$R_{G(int)}$	Internal Gate Resistance		1.7		Ω	$f = 1\ \text{MHz}, V_{AC} = 25\ \text{mV}$	
Q_{gs}	Gate to Source Charge		40		nC	$V_{DS} = 800\ \text{V}, V_{GS} = -4\ \text{V}/15\ \text{V}$ $I_D = 40\ \text{A}$ Per IEC60747-8-4 pg 21	Fig. 12
Q_{gd}	Gate to Drain Charge		34				
Q_g	Total Gate Charge		118				

Reverse Diode Characteristics ($T_c = 25^\circ\text{C}$ unless otherwise specified)

Symbol	Parameter	Typ.	Max.	Unit	Test Conditions	Note
V_{SD}	Diode Forward Voltage	4.6		V	$V_{GS} = -4\text{ V}, I_{SD} = 20\text{ A}, T_J = 25^\circ\text{C}$	Fig. 8, 9, 10
		4.2		V	$V_{GS} = -4\text{ V}, I_{SD} = 20\text{ A}, T_J = 175^\circ\text{C}$	
I_S	Continuous Diode Forward Current		62	A	$V_{GS} = -4\text{ V}, T_c = 25^\circ\text{C}$	Note 1
$I_{S, pulse}$	Diode pulse Current		120	A	$V_{GS} = -4\text{ V}$, pulse width t_p limited by T_{jmax}	Note 1
t_{rr}	Reverse Recover time	27		ns	$V_{GS} = -4\text{ V}, I_{SD} = 40\text{ A}, V_R = 800\text{ V}$ $dif/dt = 2250\text{ A}/\mu\text{s}, T_J = 175^\circ\text{C}$	Note 1
Q_{rr}	Reverse Recovery Charge	478		nC		
I_{rrm}	Peak Reverse Recovery Current	27		A		

Thermal Characteristics

Symbol	Parameter	Typ.	Unit	Test Conditions	Note
$R_{\theta JC}$	Thermal Resistance from Junction to Case	0.45	$^\circ\text{C}/\text{W}$		Fig. 21
$R_{\theta JA}$	Thermal Resistance From Junction to Ambient	40			

Typical Performance

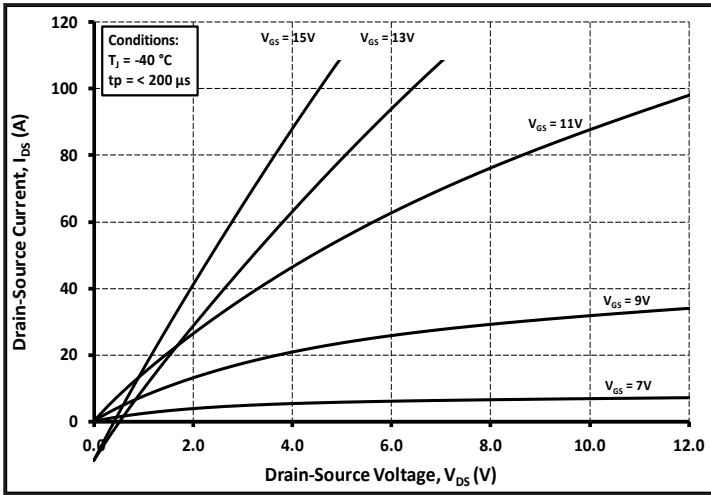

Figure 1. Output Characteristics $T_J = -40\text{ }^\circ\text{C}$

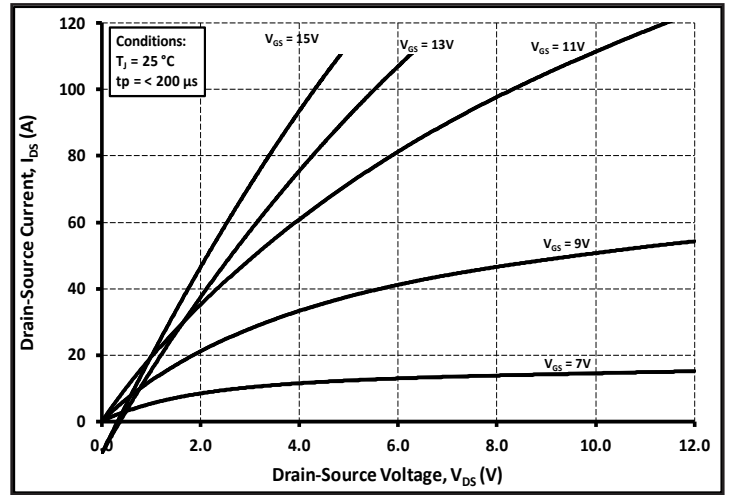

Figure 2. Output Characteristics $T_J = 25\text{ }^\circ\text{C}$

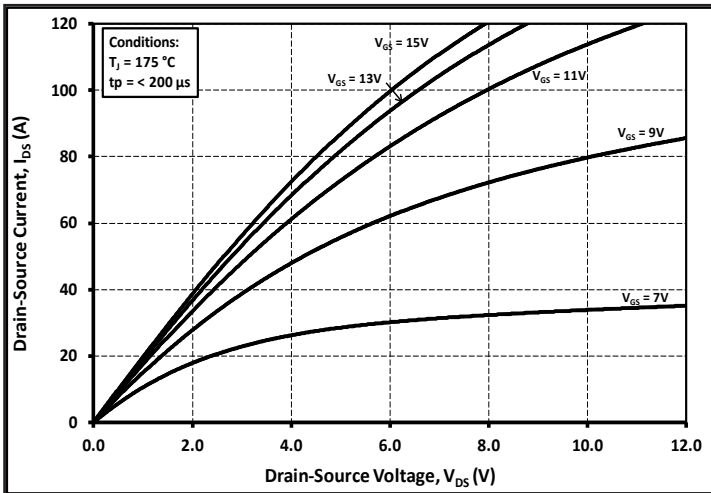

Figure 3. Output Characteristics $T_J = 175\text{ }^\circ\text{C}$

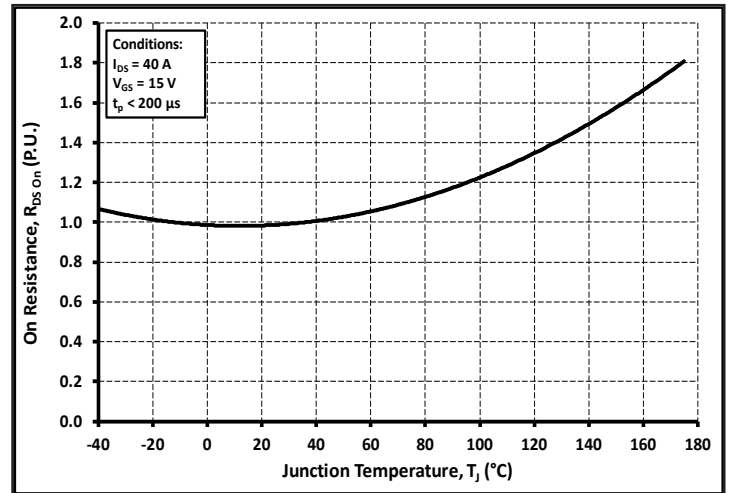

Figure 4. Normalized On-Resistance vs. Temperature

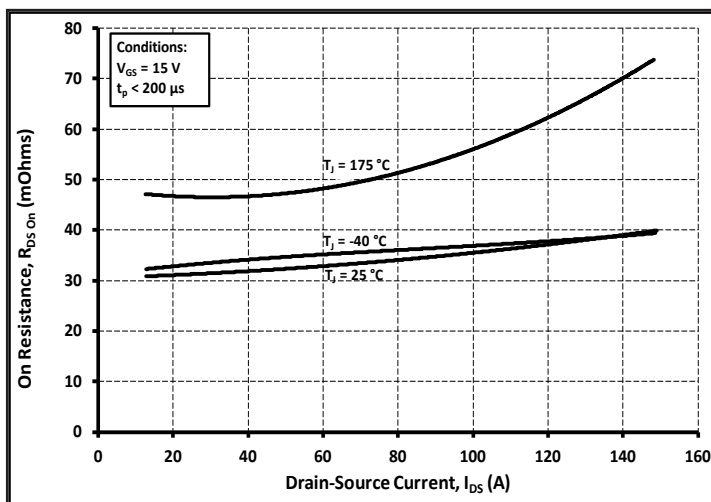

Figure 5. On-Resistance vs. Drain Current For Various Temperatures

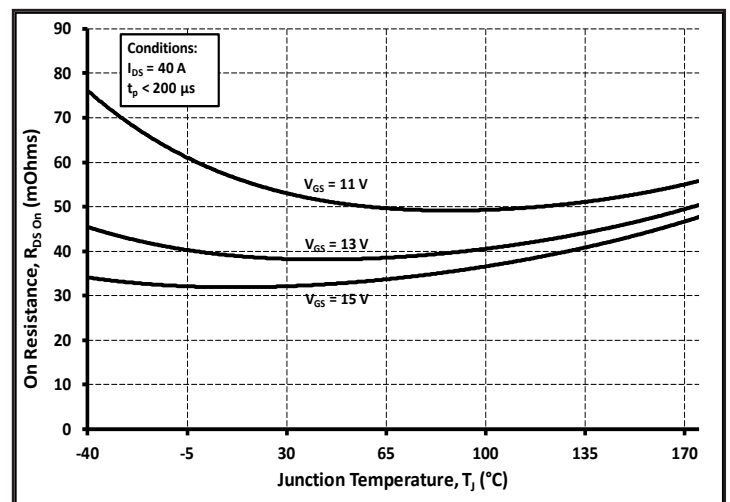

Figure 6. On-Resistance vs. Temperature For Various Gate Voltage

Typical Performance

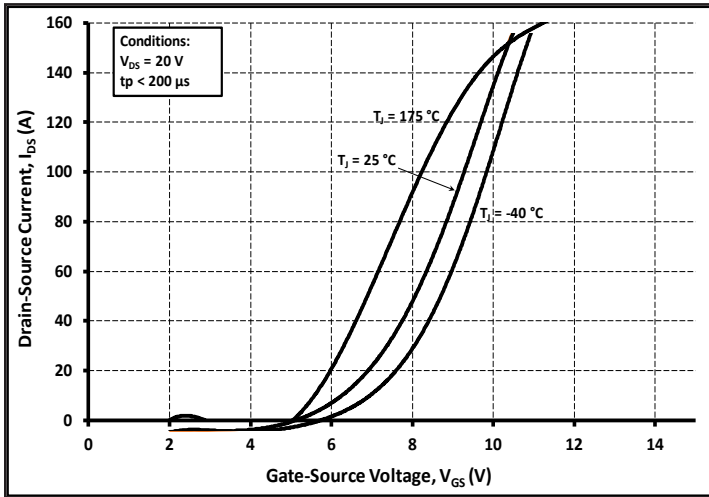

Figure 7. Transfer Characteristic for Various Junction Temperatures

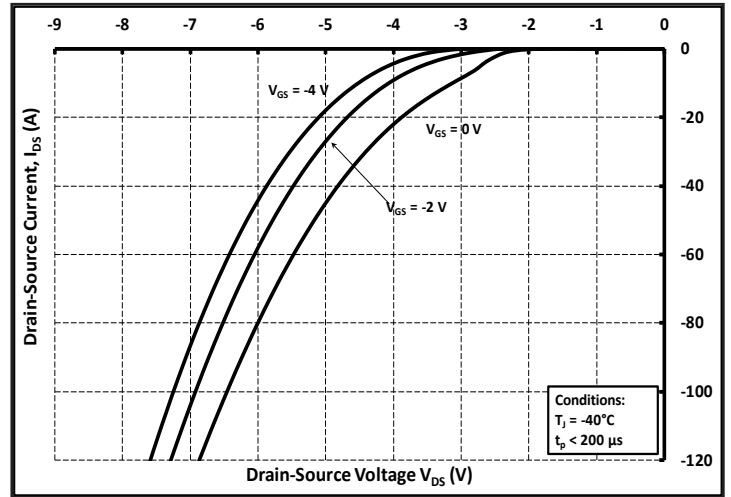

Figure 8. Body Diode Characteristic at -40 °C

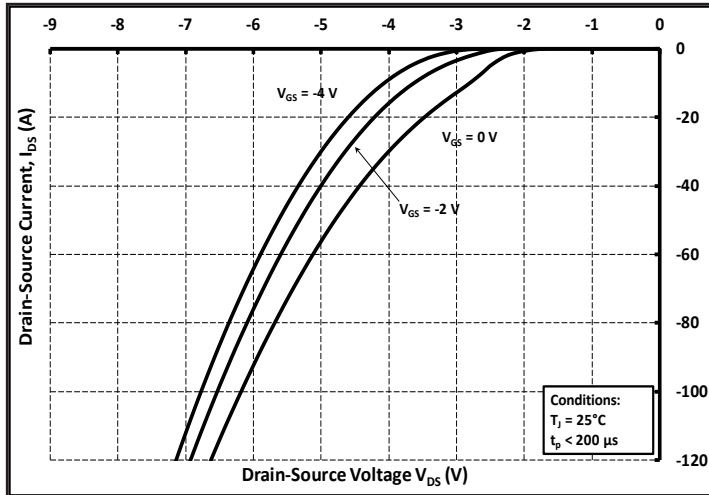

Figure 9. Body Diode Characteristic at 25 °C

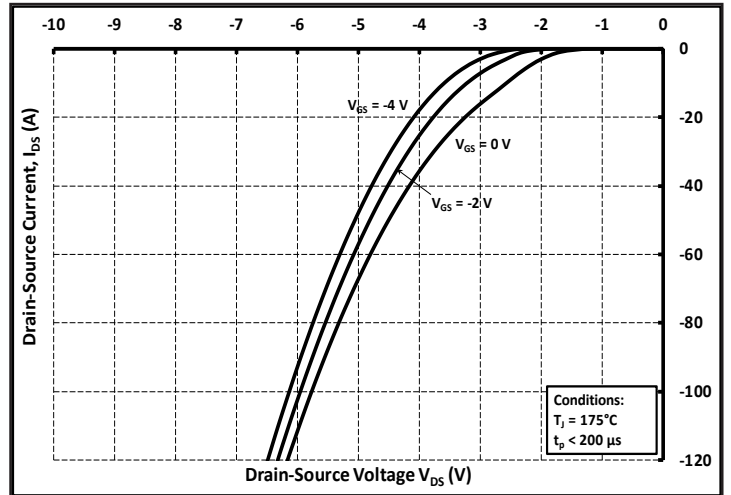

Figure 10. Body Diode Characteristic at 175 °C

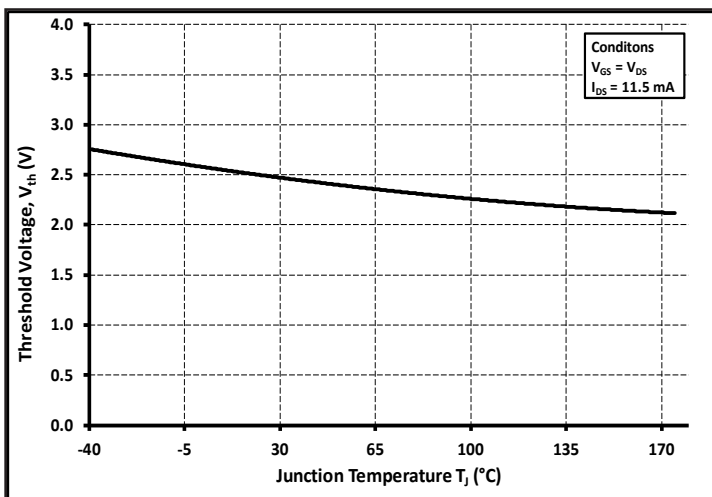

Figure 11. Threshold Voltage vs. Temperature

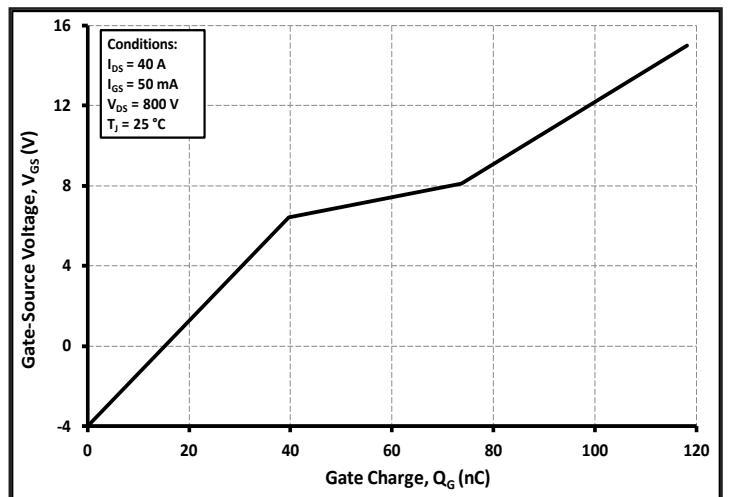

Figure 12. Gate Charge Characteristics

Typical Performance

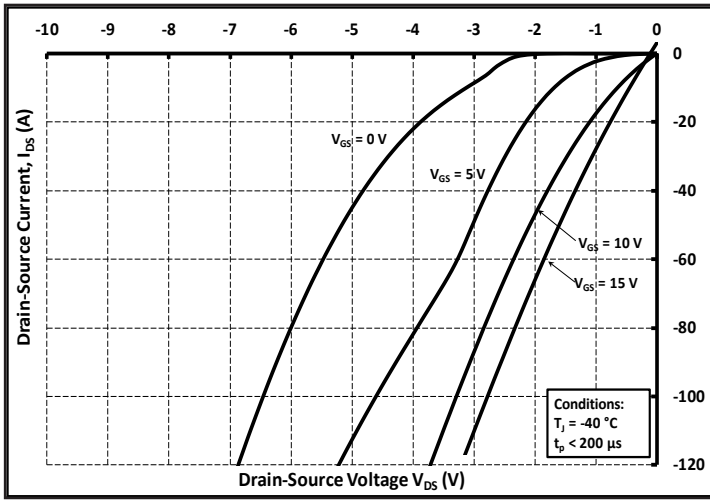

Figure 13. 3rd Quadrant Characteristic at -40 °C

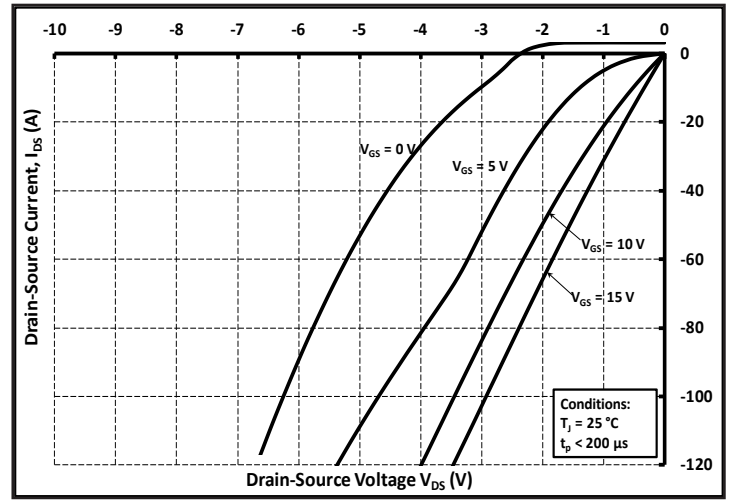

Figure 14. 3rd Quadrant Characteristic at 25 °C

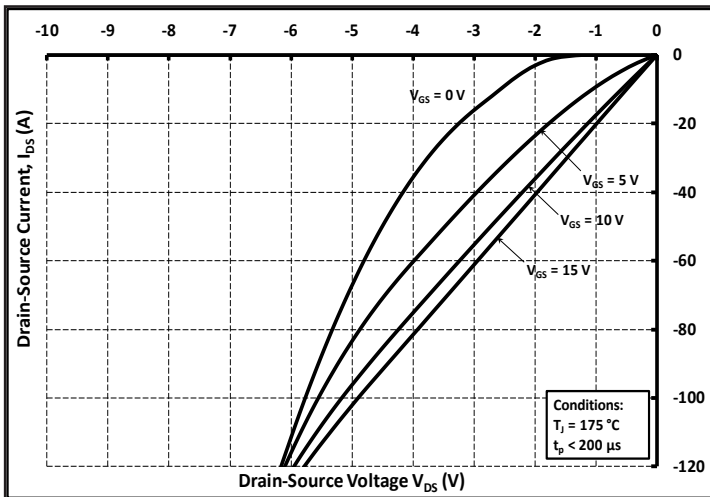

Figure 15. 3rd Quadrant Characteristic at 175 °C

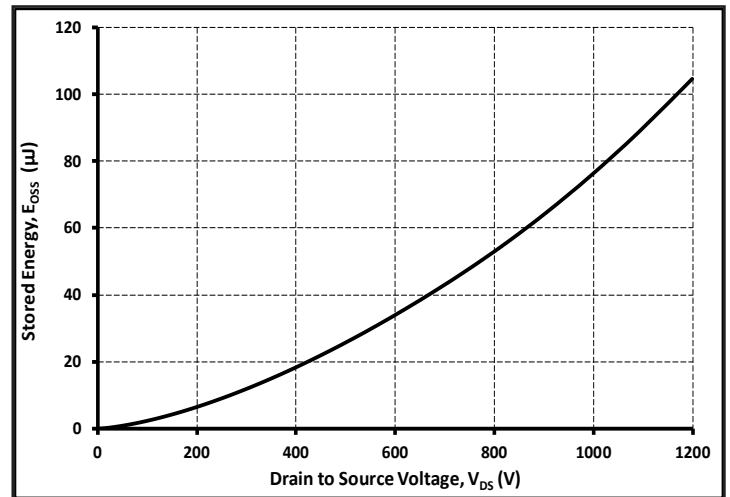

Figure 16. Output Capacitor Stored Energy

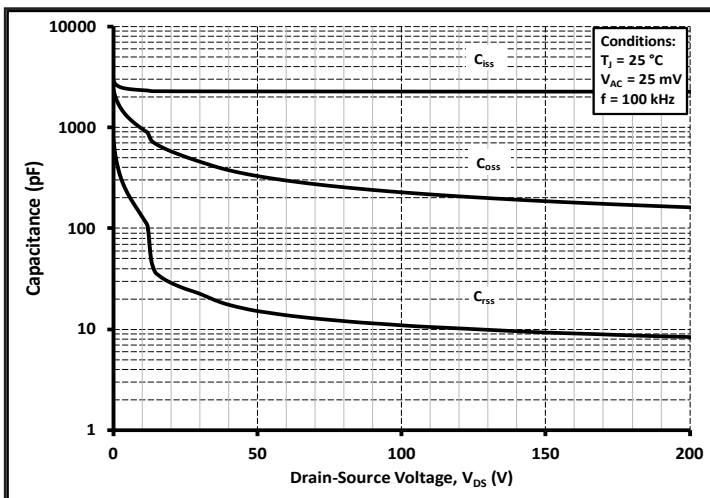

Figure 17. Capacitances vs. Drain-Source Voltage (0 - 200V)

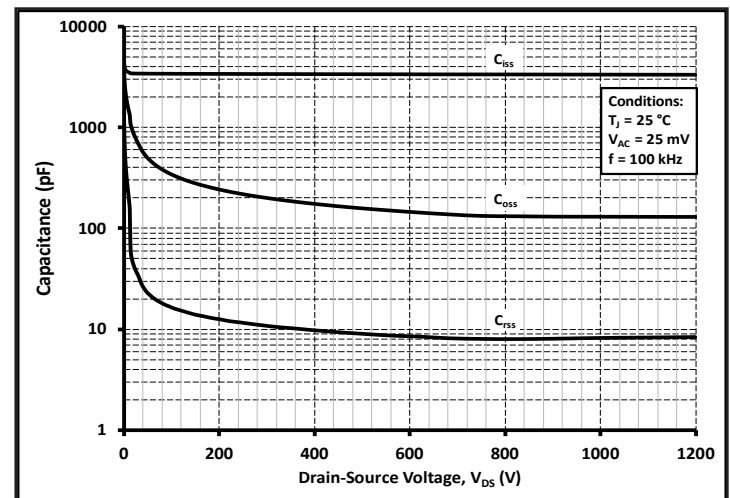

Figure 18. Capacitances vs. Drain-Source Voltage (0 - 1200V)

Typical Performance

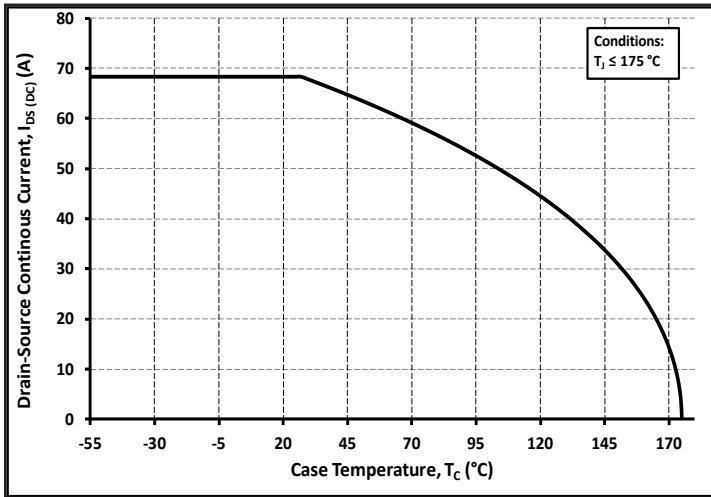

Figure 19. Continuous Drain Current Derating vs. Case Temperature

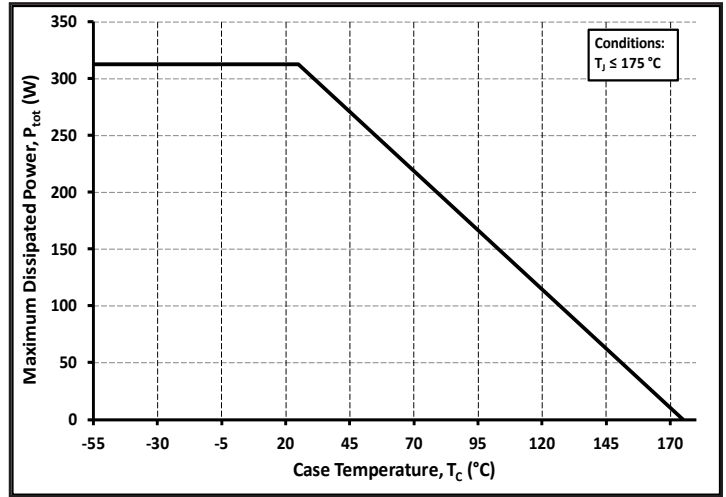

Figure 20. Maximum Power Dissipation Derating vs. Case Temperature

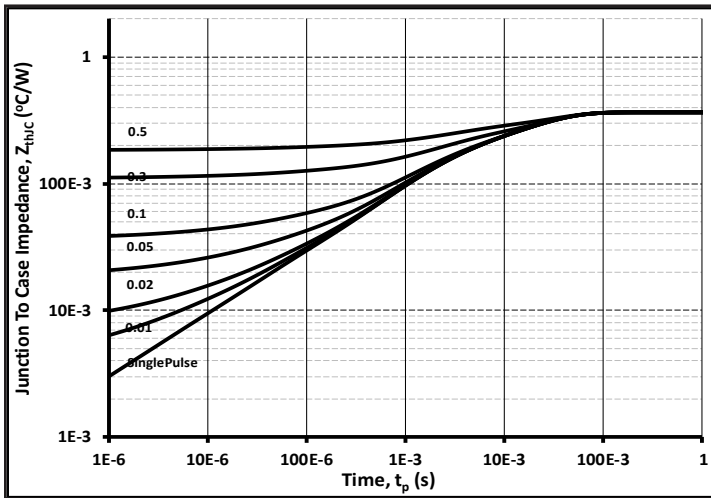

Figure 21. Transient Thermal Impedance (Junction - Case)

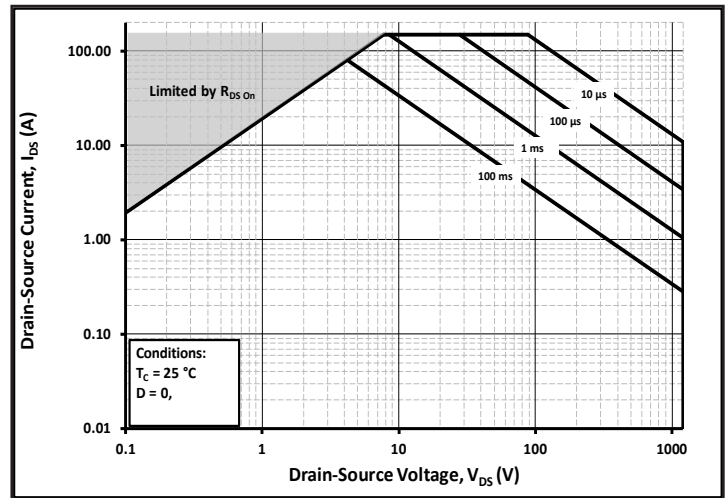

Figure 22. Safe Operating Area

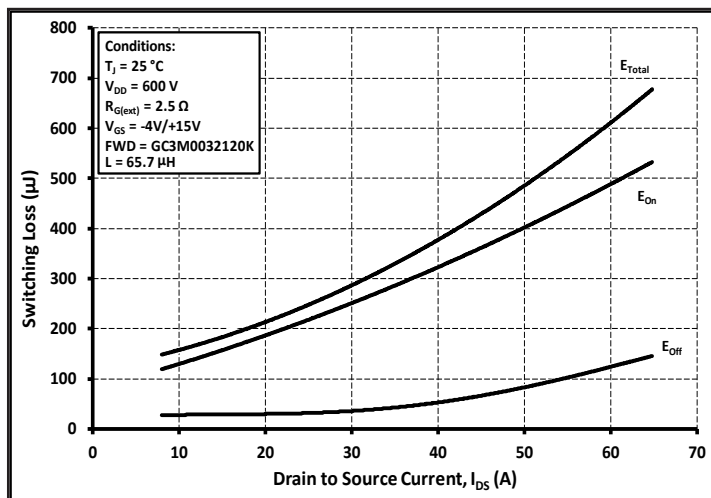

Figure 23. Clamped Inductive Switching Energy vs. Drain Current ($V_{DD} = 600V$)

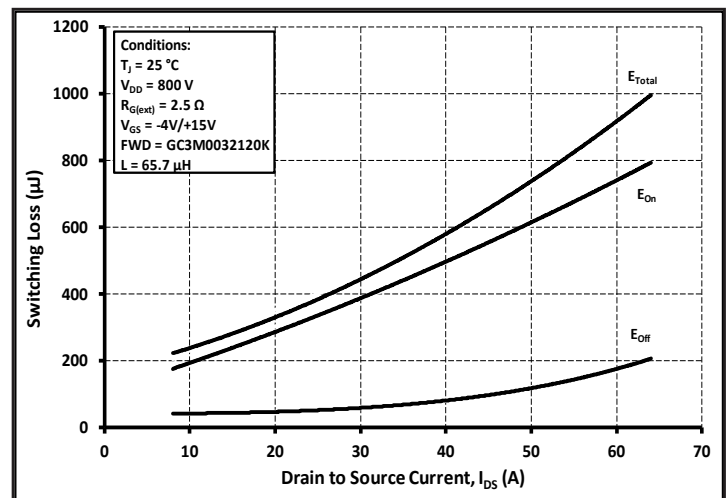

Figure 24. Clamped Inductive Switching Energy vs. Drain Current ($V_{DD} = 800V$)

Typical Performance

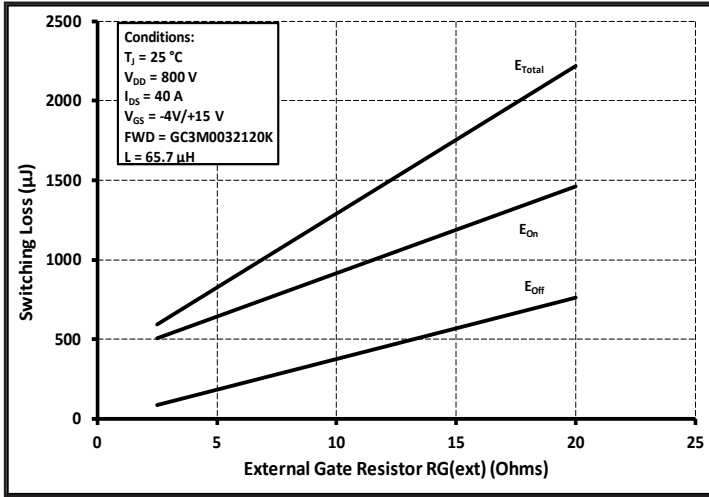

Figure 25. Clamped Inductive Switching Energy vs. $R_{G(ext)}$

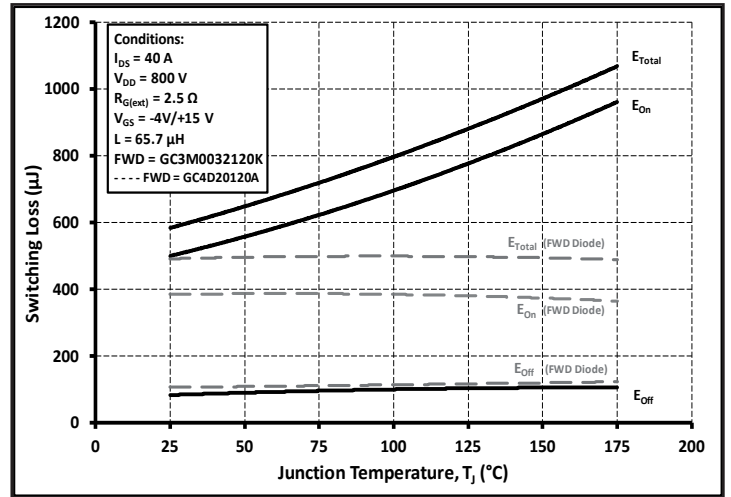

Figure 26. Clamped Inductive Switching Energy vs. Temperature

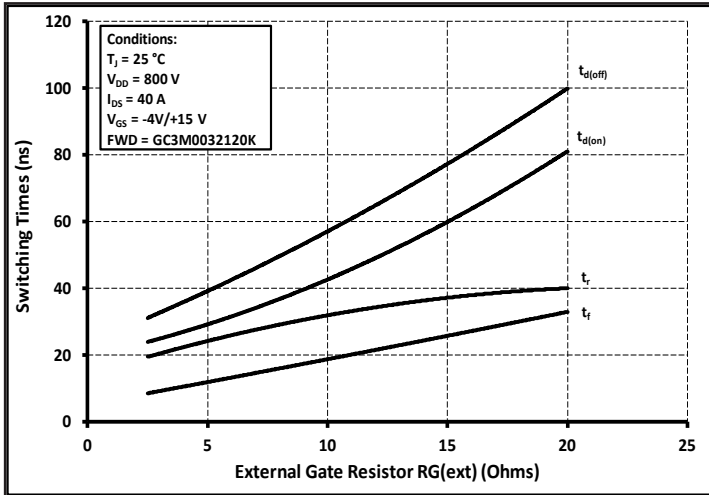

Figure 27. Switching Times vs. $R_{G(ext)}$

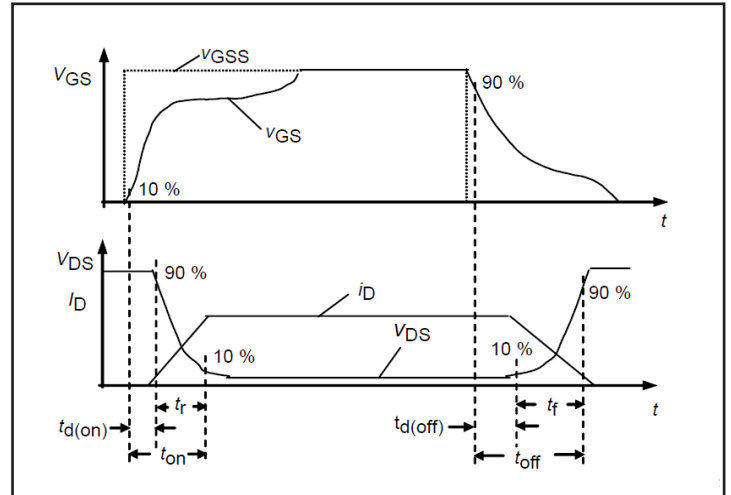

Figure 28. Switching Times Definition

Test Circuit Schematic

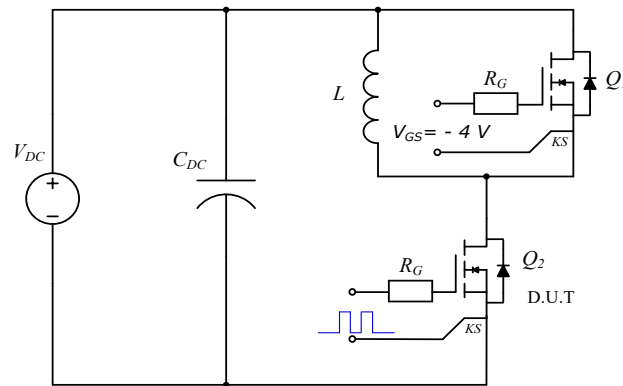
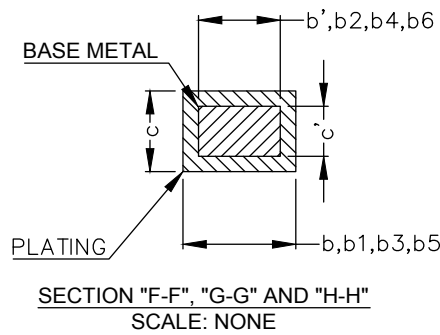
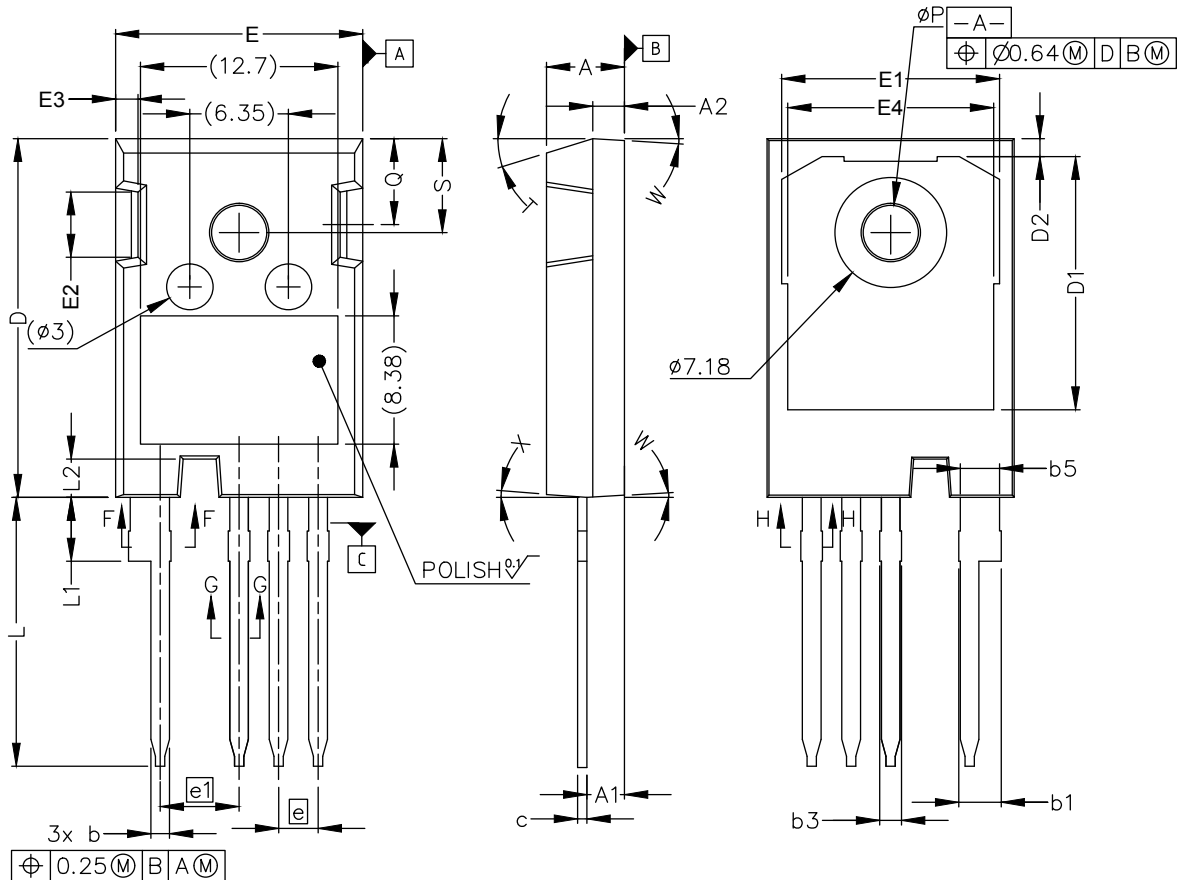

Figure 29. Clamped Inductive Switching
Waveform Test Circuit

Note (3): Turn-off and Turn-on switching energy and timing values measured using SiC MOSFET Body Diode as shown above.

Package Dimensions

Package TO-247-4L



Package Dimensions

Package TO-247-4L

NOTE ;

1. ALL METAL SURFACES: TIN PLATED, EXCEPT AREA OF CUT
2. DIMENSIONING & TOLERANCING CONFIRM TO ASME Y14.5M-1994.
3. ALL DIMENSIONS ARE IN MILLIMETERS. ANGLES ARE IN DEGREES.

SYM	MILLIMETERS		SYM	MILLIMETERS	
	MIN	MAX		MIN	MAX
A	4.83	5.21	E1	13.10	14.15
A1	2.29	2.54	E2	3.68	5.10
A2	1.91	2.16	E3	1.00	1.90
b'	1.07	1.28	E4	12.38	13.43
b	1.07	1.33	e	2.54 BSC	
b1	2.39	2.94	e1	5.08 BSC	
b2	2.39	2.84	N	4	
b3	1.07	1.60	L	17.31	17.82
b4	1.07	1.50	L1	3.97	4.37
b5	2.39	2.69	L2	2.35	2.65
b6	2.39	2.64	∅P	3.51	3.65
c'	0.55	0.65	Q	5.49	6.00
c	0.55	0.68	S	6.04	6.30
D	23.30	23.60	T	17.5° REF.	
D1	16.25	17.65	W	3.5° REF.	
D2	0.95	1.25	X	4° REF.	
E	15.75	16.13			

Recommended Solder Pad Layout

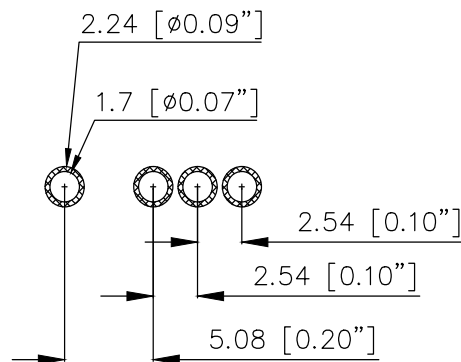

单击下面可查看定价，库存，交付和生命周期等信息

[>>SUPSiC\(国晶微\)](#)