

Wire Wound Type Common Mode Filter

WCM4532F2SV-SERIES-HI

1. Features

1. High common mode impedance at high frequency cause excellent noise suppression performance.
2. WCM4532F2SV series realizes small size and low profile. 4.5x3.2x2.8 mm.
3. 100% Lead(Pb) & Halogen-Free and RoHS compliant.
4. High reliability -Reliability tests comply with AEC-Q200
5. Operating temperature -55~+125°C (Including self - temperature rise)



2. Dimension

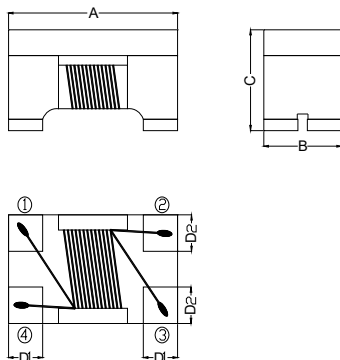

Recommended PC Board Pattern

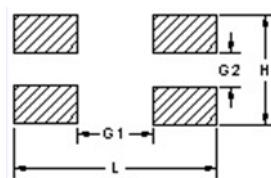

Series	A(mm)	B(mm)	C(mm)	D1(mm)	D2(mm)	L(mm)	H(mm)	G1(mm)	G2(mm)
4532F2SV	4.5±0.2	3.2±0.2	2.8±0.2	0.90±0.15	1.05±0.15	5.0	3.6	3.0	1.2

Units: mm

3. Part Numbering

WCM	4532	F	2	S	V	-	142	T	20	-	HI
A	B	C	D	E	F		G	H	I		J

- A: Series
 B: Dimension
 C: Material Ferrite Core
 D: Number of Lines 2=2 lines
 E: Type S=Shielded , N=Unshielded
 F: Category Code V=Vehicle
 G: Impedance 142=1400Ω
 H: Packaging T=Taping and Reel
 I: Rated Current 20=2000mA
 J : Control S/N

4. Specification

TAI-TECH Part Number	Common mode Impedance (Ω)		Test Frequency (MHz)	DC Resistance (Ω) max.	Rated Current (mA) max.	Rated Volt. (Vdc) max.	Withstand Volt. (Vdc) max.	IR (Ω) min.
	min	typ.						
WCM4532F2SV-900T40-HI	68 min	90 typ.	100	0.050	4000	50	125	10M
WCM4532F2SV-231T35-HI	173 min	230 typ.	100	0.050	3500	50	125	10M
WCM4532F2SV-421T32-HI	300 min	420 typ.	100	0.055	3200	50	125	10M
WCM4532F2SV-601T25-HI	450 min	600 typ.	100	0.060	2500	50	125	10M
WCM4532F2SV-901T23-HI	650 min	900 typ.	100	0.070	2300	50	125	10M
WCM4532F2SV-142T20-HI	1000 min.	1400 typ.	100	0.100	2000	50	125	10M
WCM4532F2SV-282T09-HI	2100 min	2800 typ.	100	0.350	900	50	125	10M

Note: When current is applied , the temperature of the part should not exceed 125°C

www.tai-tech.com.tw

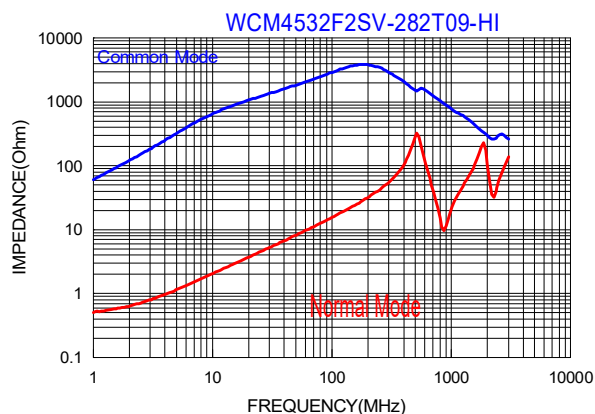
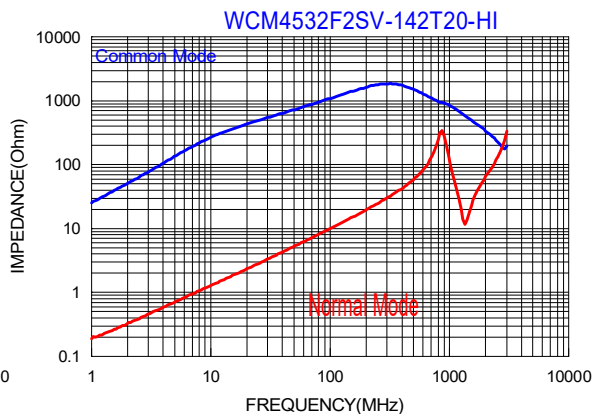
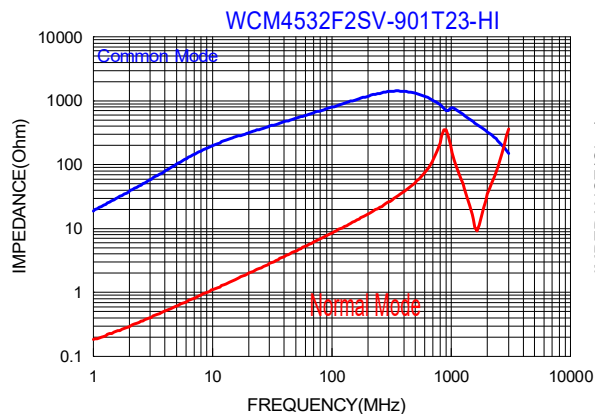
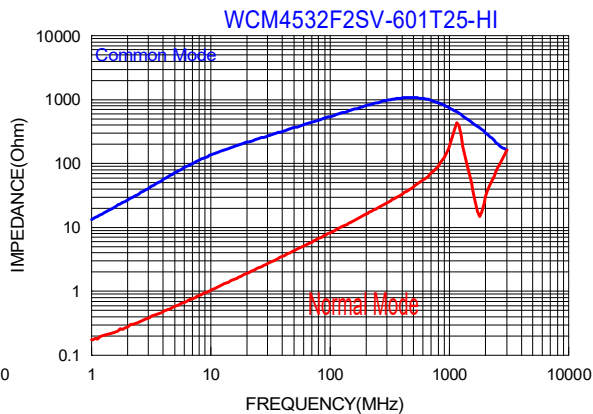
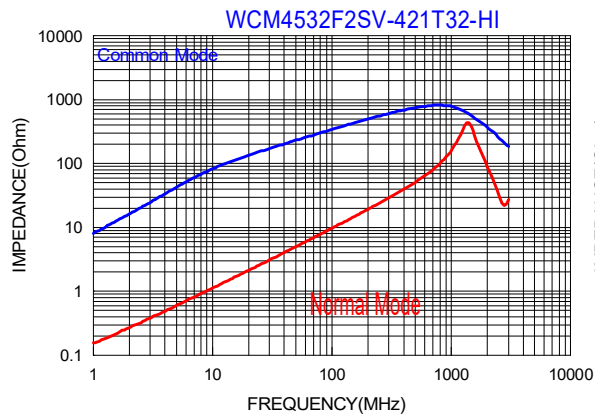
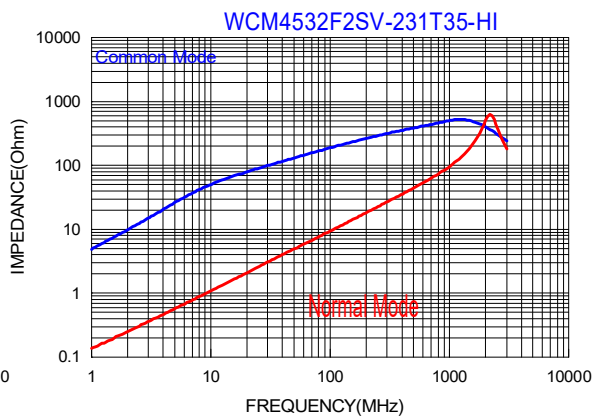
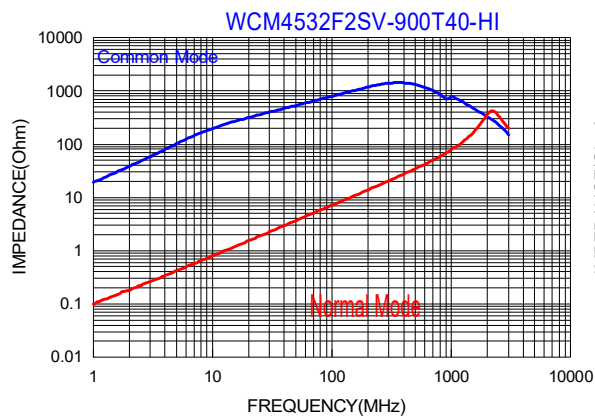

5. Schematic Diagram

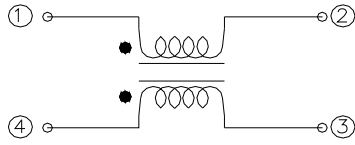

单击下面可查看定价，库存，交付和生命周期等信息

[>>TAI-TECH\(台庆\)](#)