

Specification for Approval

Date: 2016/09/20

Customer : _____

TAI-TECH P/N: AHP201610HF-SERIES

CUSTOMER P/N: _____

DESCRIPTION: _____

QUANTITY: _____ pcs

| | | |
|----------------------------|--|--|
| REMARK: | | |
| | | |
| Customer Approval Feedback | | |
| | | |

西北臺慶科技股份有限公司
TAI-TECH Advanced Electronics Co., Ltd

西北臺慶科技股份有限公司
 TAI-TECH Advanced Electronics Co., Ltd
Headquarter:
 NO.1 YOU 4TH ROAD, YOUTH INDUSTRIAL DISTRICT, YANG-MEI,
 TAO-YUAN HSIEN, TAIWAN, R.O.C.
 TEL: +886-3-4641148 FAX: +886-3-4643565
 http://www.tai-tech.com.tw
 E-mail: sales@tai-tech.com.tw

東莞臺慶精密電子有限公司
 DONGGUAN TAI-TECH ADVANCED ELECTRONICS CO., LTD
 JITIGANG MANAGEMENT DISTRICT, HUANGJIANG, DONGGUAN,
 GUANGDONG, CHINA
 TEL: +86-769-3365488 FAX: +86-769-3366896
 E-mail: twnwe@pub.dgnet.gd.cn

Office:
 金亨國際有限公司
 KAMHENG INTERNATIONAL LIMITED
 TEL: +86-852-25772033 FAX: +86-852-28817778

臺慶精密電子(昆山)有限公司
 TAI-TECH ADVANCED ELECTRONICS(KUNSHAN) CO., LTD
 SHINWHA ROAD, KUNJIA HI-TECH INDUSTRIAL PARK, KUN-SHAN,
 JIANG-SU, CHINA
 TEL: +86-512-57619396 FAX: +86-512-57619688
 E-mail: hui@tai-tech.com.tw

Office:
 北欣國際有限公司
 NORTH STAR INTERNATIONAL LIMITED
 TEL: +86-512-57619396 FAX: +86-512-57619688

Sales Dep.

| APPROVED | CHECKED |
|----------|---------|
| | |

R&D Center

| APPROVED | CHECKED | DRAWN |
|------------------|------------------|-------------------|
| 楊祥忠 Mike Yang | 詹偉特 Jack Chan | 孔妍暄 Chloe Kung |

Power Inductor

AHP201610HF-SERIES

1. Features

1. This specification applies Low Profile Power Inductors.
2. 100% Lead(Pb) & Halogen-Free and RoHS compliant.



2. Dimension

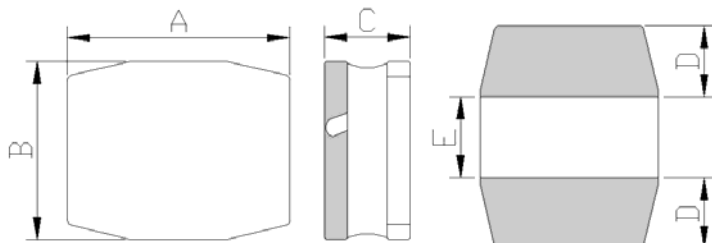

| Series | A(mm) | B(mm) | C(mm) | D(mm) | E(mm) |
|-------------|---------------|---------------|--------|-----------|-----------|
| AHP201610HF | 2.0 -0.1/+0.2 | 1.6 -0.1/+0.2 | 1.0Max | 0.50 ref. | 1.00 ref. |

Units: mm

3. Part Numbering

AHP **201610** **HF** - **R24** **M**

A B C D E

A: Series
 B: Dimension
 C: Lead Free Material
 D: Inductance R24=0.24uH
 E: Inductance Tolerance M=±20%

4. Specification

| TAI-TECH Part Number | Inductance (uH) | Tolerance (%) | Test Frequency (Hz) | DCR (Ω) typ. | DCR (Ω) Max. | I sat (A) typ. | I sat (A) Max. | I rms (A) typ | I rms (A) MAX |
|----------------------|-----------------|---------------|---------------------|--------------|--------------|----------------|----------------|---------------|---------------|
| AHP201610HF-R24M | 0.24 | ±20 | 1V/1M | 0.017 | 0.021 | 7.00 | 6.00 | 5.60 | 5.00 |
| AHP201610HF-R33M | 0.33 | ±20 | 1V/1M | 0.023 | 0.029 | 5.50 | 5.00 | 5.10 | 4.60 |
| AHP201610HF-R47M | 0.47 | ±20 | 1V/1M | 0.028 | 0.035 | 5.20 | 4.30 | 4.50 | 4.00 |
| AHP201610HF-R68M | 0.68 | ±20 | 1V/1M | 0.040 | 0.050 | 4.30 | 3.70 | 3.80 | 3.40 |
| AHP201610HF-1R0M | 1.0 | ±20 | 1V/1M | 0.053 | 0.065 | 3.60 | 3.00 | 3.10 | 2.80 |
| AHP201610HF-1R5M | 1.5 | ±20 | 1V/1M | 0.100 | 0.120 | 2.60 | 2.30 | 2.40 | 2.10 |
| AHP201610HF-2R2M | 2.2 | ±20 | 1V/1M | 0.110 | 0.130 | 2.10 | 1.90 | 2.10 | 1.90 |
| AHP201610HF-3R3M | 3.3 | ±20 | 1V/1M | 0.180 | 0.216 | 1.50 | 1.30 | 1.50 | 1.30 |
| AHP201610HF-4R7M | 4.7 | ±20 | 1V/1M | 0.190 | 0.230 | 1.10 | 1.00 | 1.10 | 1.00 |

Note:

Isat : Based on inductance change ($\Delta L/L0 : \leq 30\%$) @ ambient temp. 25°C

Irms : Based on temperature rise ($\Delta T : 40^\circ\text{C}$.) Max

Measurement board data

Irms

I

Material : FR4

Board dimensions : 100 X 50 X 1.6t mm

Pattern dimensions: 45 X 30 mm (Double side board)

Pattern thickness : 50 μm

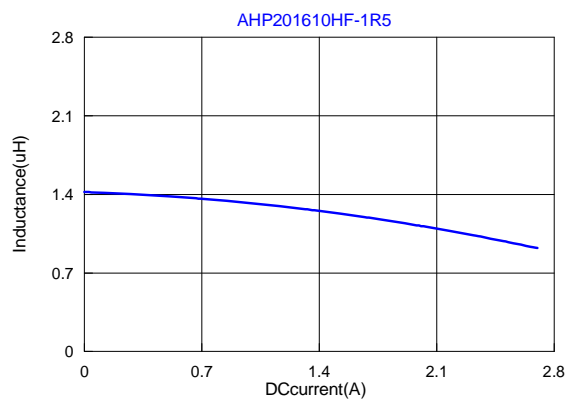
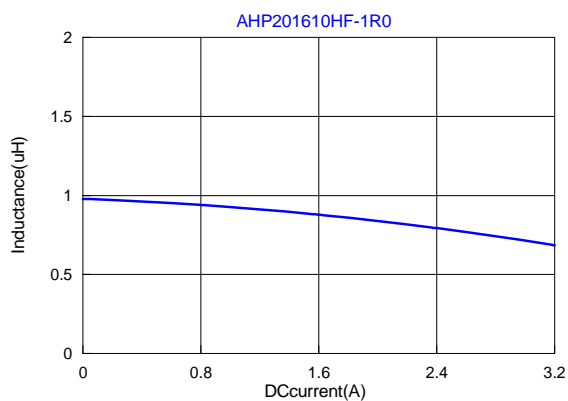
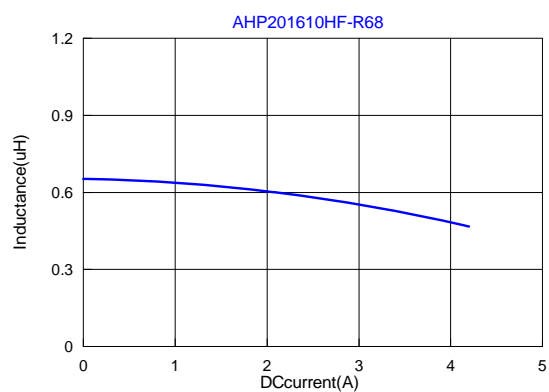
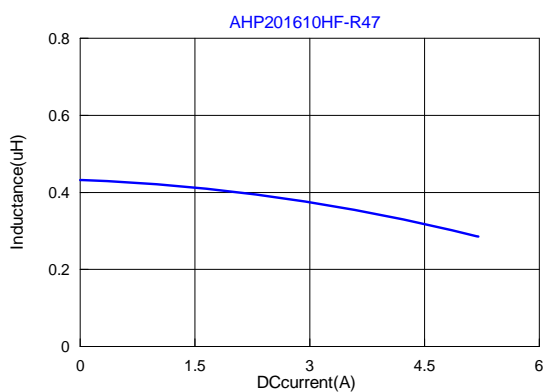
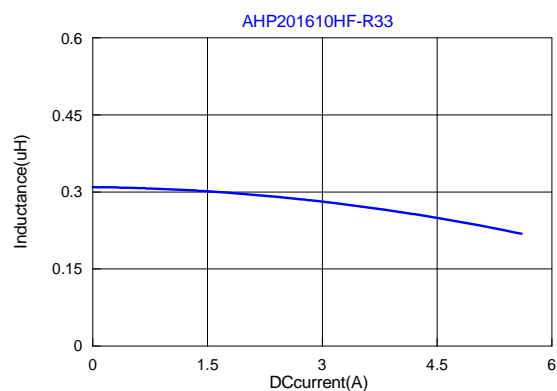
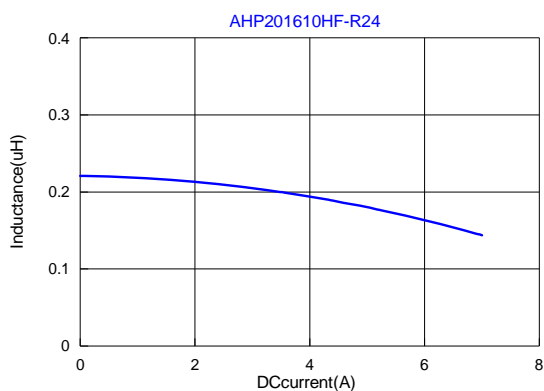

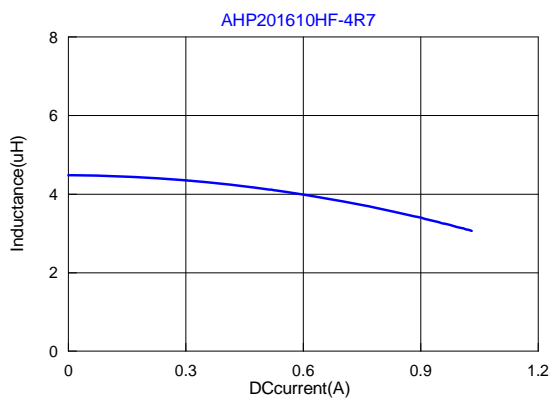
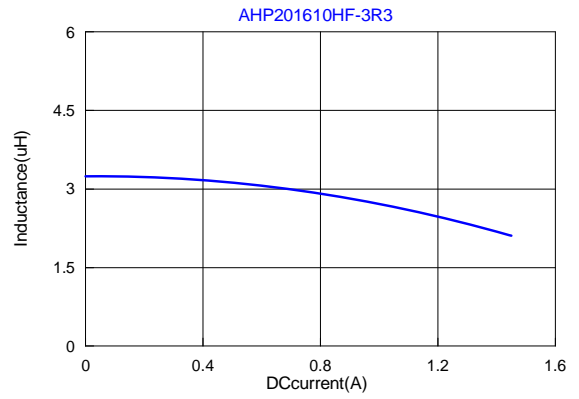
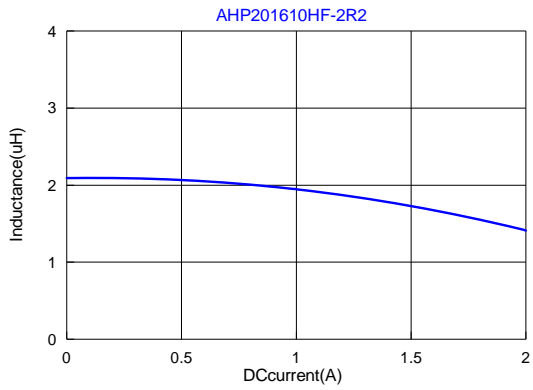

5. Material List

| No. | Description | Specification |
|-----|-------------|-------------------------------------|
| a. | Core | Metal Core |
| b. | Glue | Epoxy or Epoxy with magnetic powder |
| c. | Termination | Tin (Pb Free) |
| d. | Wire | Enameled Copper Wire |

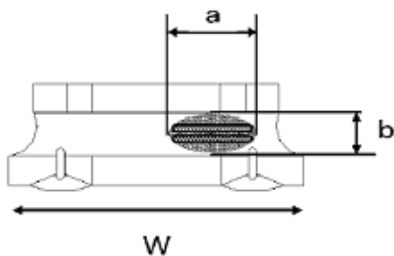
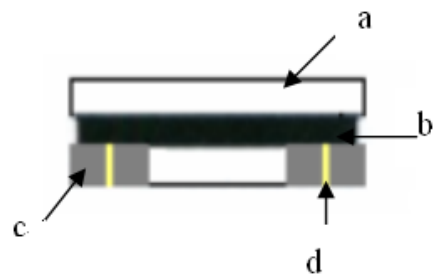

Appearance of exposed wire tolerance limit :

1. Width direction (dimension a) : Acceptable when $a \leq w/2$
Nonconforming when $a > w/2$
2. Length direction (dimension b) : Dimension b is not specified.
3. The total area of exposed wire occurring to each sides is not greater than 50% of coating resin area, and is acceptable.

6. Reliability and Test Condition

| Item | Performance | Test Condition |
|------------------------------------|--|---|
| Operating temperature | -40~+125°C (Including self - temperature rise) | |
| Storage temperature | -40~+125°C (on board) | |
| Electrical Performance Test | | |
| Inductance | Refer to standard electrical characteristics list. | HP4284A,CH11025,CH3302,CH1320,CH1320S LCR Meter. |
| DCR | | CH16502,Agilent33420A Micro-Ohm Meter. |
| Saturation Current (Isat) | $\Delta L \leq 30\%$ typical. | Saturation DC Current (Isat) will cause L0 to drop $\Delta L(\%)$ (keep quickly). |
| Heat Rated Current (Irms) | Approximately $\Delta T \leq 40^\circ\text{C}$ | Heat Rated Current (Irms) will cause the coil temperature rise $\Delta T(^\circ\text{C})$ without core loss. 1.Applied the allowed DC current(keep 1 min.). 2.Temperature measured by digital surface thermometer |
| Reliability Test | | |
| Life Test | Appearance : No damage. Inductance : within $\pm 10\%$ of initial value Q : Shall not exceed the specification value. RDC : within $\pm 15\%$ of initial value and shall not exceed the specification value | Preconditioning: Run through IR reflow for 2 times.(IPC/JEDEC J-STD-020DClassification Reflow Profiles) Temperature : $125 \pm 2^\circ\text{C}$ (Inductor) Applied current : rated current Duration : 1000 ± 12 hrs Measured at room temperature after placing for 24 ± 2 hrs |
| Load Humidity | | Preconditioning: Run through IR reflow for 2 times.(IPC/JEDEC J-STD-020DClassification Reflow Profiles) Humidity : $85 \pm 2\%$ R.H, Temperature : $85^\circ\text{C} \pm 2^\circ\text{C}$ Duration : 1000hrs Min. with 100% rated current Measured at room temperature after placing for 24 ± 2 hrs |
| Moisture Resistance | | Preconditioning: Run through IR reflow for 2 times.(IPC/JEDEC J-STD-020DClassification Reflow Profiles 1. Baked at 50°C for 25hrs, measured at room temperature after placing for 4 hrs. 2. Raise temperature to $65 \pm 2^\circ\text{C}$ 90-100%RH in 2.5hrs, and keep 3 hours, cool down to 25°C in 2.5hrs. 3. Raise temperature to $65 \pm 2^\circ\text{C}$ 90-100%RH in 2.5hrs, and keep 3 hours, cool down to 25°C in 2.5hrs,keep at 25°C for 2 hrs then keep at -10°C for 3 hrs 4. Keep at 25°C 80-100%RH for 15min and vibrate at the frequency of 10 to 55 Hz to 10 Hz, measure at room temperature after placing for 1~2 hrs. |
| Thermal shock | | Preconditioning: Run through IR reflow for 2 times.(IPC/JEDEC J-STD-020DClassification Reflow Profiles Condition for 1 cycle Step1 : $-40 \pm 2^\circ\text{C}$ 30 \pm 5min Step2 : $25 \pm 2^\circ\text{C}$ \leq 0.5min Step3 : $125 \pm 2^\circ\text{C}$ 30 \pm 5min Number of cycles : 500 Measured at room temperature after placing for 24 ± 2 hrs |
| Vibration | | Oscillation Frequency: 10 ~ 2K ~ 10Hz for 20 minutes Equipment : Vibration checker Total Amplitude:1.52mm \pm 10% Testing Time : 12 hours(20 minutes, 12 cycles each of 3 orientations). |

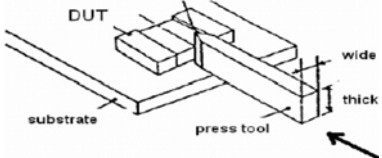
| Item | Performance | Test Condition | | | | | | | | | | | | | | | |
|------------------------------|---|---|------------------|----------------------------|--|---------------------|----------------------------|----------------|----|----|-----------|------|------|----|----|-----------|------|
| Shock | Appearance : No damage. Inductance : within±10% of initial value | <table border="1"> <thead> <tr> <th>Type</th> <th>Peak value (g' s)</th> <th>Normal duration (D) (ms)</th> <th>Wave form</th> <th>Velocity change (V)/ft/sec</th> </tr> </thead> <tbody> <tr> <td>SMD</td> <td>50</td> <td>11</td> <td>Half-sine</td> <td>11.3</td> </tr> <tr> <td>Lead</td> <td>50</td> <td>11</td> <td>Half-sine</td> <td>11.3</td> </tr> </tbody> </table> | Type | Peak value (g' s) | Normal duration (D) (ms) | Wave form | Velocity change (V)/ft/sec | SMD | 50 | 11 | Half-sine | 11.3 | Lead | 50 | 11 | Half-sine | 11.3 |
| Type | Peak value (g' s) | Normal duration (D) (ms) | Wave form | Velocity change (V)/ft/sec | | | | | | | | | | | | | |
| SMD | 50 | 11 | Half-sine | 11.3 | | | | | | | | | | | | | |
| Lead | 50 | 11 | Half-sine | 11.3 | | | | | | | | | | | | | |
| Bending | Q : Shall not exceed the specification value. RDC : within ±15% of initial value and shall not exceed the specification value | Shall be mounted on a FR4 substrate of the following dimensions: >=0805:40x100x1.2mm <0805:40x100x0.8mm Bending depth: >=0805:1.2mm <0805:0.8mm duration of 10 sec. | | | | | | | | | | | | | | | |
| Soderability | More than 95% of the terminal electrode should be covered with solder. | Preheat: 150°C, 60sec. Solder: Sn96.5% Ag3% Cu0.5% Temperature: 245±5°C. Flux for lead free: Rosin. 9.5%. Dip time: 4±1sec. Depth: completely cover the termination | | | | | | | | | | | | | | | |
| Resistance to Soldering Heat | Appearance : No damage. Inductance : within±10% of initial value Q : Shall not exceed the specification value. RDC : within ±15% of initial value and shall not exceed the specification value | Number of heat cycles: 1 <table border="1"> <thead> <tr> <th>Temperature (°C)</th> <th>Time(s)</th> <th>Temperature ramp/immersion and emersion rate</th> </tr> </thead> <tbody> <tr> <td>260 ±5(solder temp)</td> <td>10 ±1</td> <td>25mm/s ±6 mm/s</td> </tr> </tbody> </table> | Temperature (°C) | Time(s) | Temperature ramp/immersion and emersion rate | 260 ±5(solder temp) | 10 ±1 | 25mm/s ±6 mm/s | | | | | | | | | |
| Temperature (°C) | Time(s) | Temperature ramp/immersion and emersion rate | | | | | | | | | | | | | | | |
| 260 ±5(solder temp) | 10 ±1 | 25mm/s ±6 mm/s | | | | | | | | | | | | | | | |
| Terminal Strength | | Preconditioning: Run through IR reflow for 2 times.(IPC/JEDEC J-STD-020DClassification Reflow Profiles With the component mounted on a PCB with the device to be tested, apply a force (>0805:1kg , <=0805:0.5kg)to the side of a device being tested. This force shall be applied for 60 +1 seconds. Also the force shall be applied gradually as not to apply a shock to the component being tested.  | | | | | | | | | | | | | | | |

7. Soldering and Mounting

7-1. Soldering

Mildly activated rosin fluxes are preferred. TAI-TECH terminations are suitable for all wave and re-flow soldering systems. If hand soldering cannot be avoided, the preferred technique is the utilization of hot air soldering tools.

7-1.1 Solder re-flow:

Recommended temperature profiles for re-flow soldering in Figure 1.

7-1.2 Soldering Iron(Figure 2):

Products attachment with a soldering iron is discouraged due to the inherent process control limitations. In the event that a soldering iron must be employed the following precautions are recommended.

- Preheat circuit and products to 150°C
- Never contact the ceramic with the iron tip
- Use a 20 watt soldering iron with tip diameter of 1.0mm
- 355°C tip temperature (max)
- 1.0mm tip diameter (max)
- Limit soldering time to 4-5 sec.

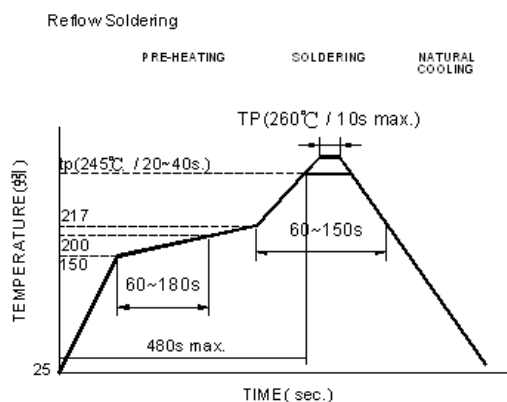

Reflow times: 3 times max.

Fig.1

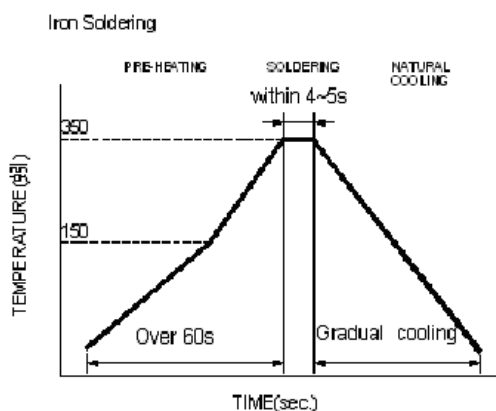

Iron Soldering times: 1 times max.

Fig.2

7-2. Recommended PC Board Pattern

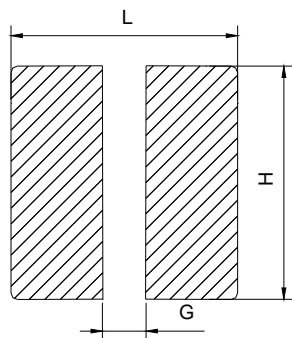

| L(mm) | G(mm) | H(mm) |
|-------|-------|-------|
| 2.3 | 0.8 | 1.9 |

8. Packaging Information

8-1. Reel Dimension

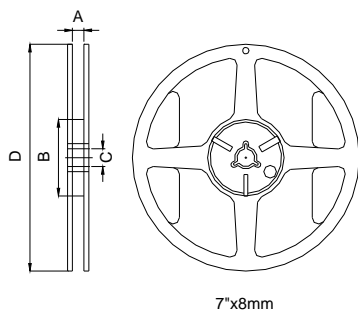

| Type | A(mm) | B(mm) | C(mm) | D(mm) |
|--------|---------|---------|--------|-------|
| 7"x8mm | 8.4±1.0 | 50 min. | 13±0.8 | 178±2 |

8-2. Tape Dimension / 8mm

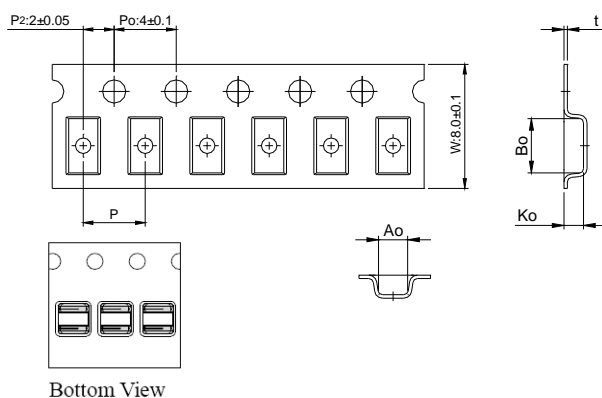

| Series | Size | Bo(mm) | Ao(mm) | Ko(mm) | P(mm) | t(mm) |
|--------|--------|---------|---------|----------|---------|-----------|
| AHP | 201610 | 2.5±0.1 | 2.0±0.1 | 1.40±0.1 | 4.0±0.1 | 0.23±0.05 |

8-3. Packaging Quantity

| | |
|-------------|--------|
| Chip size | 201610 |
| Chip / Reel | 2000 |

8-4. Tearing Off Force

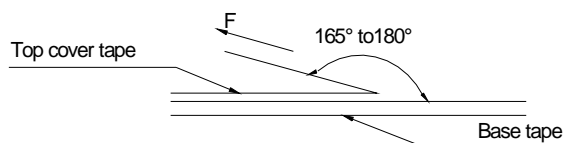

The force for tearing off cover tape is 15 to 80 grams in the arrow direction under the following conditions.

| Room Temp. (°C) | Room Humidity (%) | Room atm (hPa) | Tearing Speed mm/min |
|-----------------|-------------------|----------------|----------------------|
| 5-35 | 45-85 | 860-1060 | 300 |

Application Notice

- Storage Conditions(component level)
 - To maintain the solderability of terminal electrodes:
 1. TAI-TECH products meet IPC/JEDEC J-STD-020D standard-MSL, level 1.
 2. Temperature and humidity conditions: Less than 40°C and 60% RH.
 3. Recommended products should be used within 12 months form the time of delivery.
 4. The packaging material should be kept where no chlorine or sulfur exists in the air.
- Transportation
 1. Products should be handled with care to avoid damage or contamination from perspiration and skin oils.
 2. The use of tweezers or vacuum pick up is strongly recommended for individual components.
 3. Bulk handling should ensure that abrasion and mechanical shock are minimized.

单击下面可查看定价，库存，交付和生命周期等信息

[>>TAI-TECH\(台庆\)](#)

[>>点击查看相关商品](#)