

Specification for Approval

Date: 2014/10/27

Customer : 友仁達

TAI-TECH P/N: UHP201610NF-SERIES

CUSTOMER P/N: _____

DESCRIPTION: _____

QUANTITY: _____ pcs

REMARK:		
Customer Approval Feedback		

西北臺慶科技股份有限公司
TAI-TECH Advanced Electronics Co., Ltd

西北臺慶科技股份有限公司
 TAI-TECH Advanced Electronics Co., Ltd
Headquarter:
 NO.1 YOU 4TH ROAD, YOUTH INDUSTRIAL DISTRICT, YANG-MEI,
 TAO-YUAN HSIEN, TAIWAN, R.O.C.
 TEL: +886-3-4641148 FAX: +886-3-4643565
 http://www.tai-tech.com.tw
 E-mail: sales@tai-tech.com.tw

東莞臺慶精密電子有限公司
 DONGGUAN TAI-TECH ADVANCED ELECTRONICS CO., LTD
 JITIGANG MANAGEMENT DISTRICT, HUANGJIANG, DONGGUAN,
 GUANGDONG, CHINA
 TEL: +86-769-3365488 FAX: +86-769-3366896
 E-mail: twnwe@pub.dgnet.gd.cn

Office:
 金亨國際有限公司
 KAMHENG INTERNATIONAL LIMITED
 TEL: +86-852-25772033 FAX: +86-852-28817778

臺慶精密電子(昆山)有限公司
 TAI-TECH ADVANCED ELECTRONICS(KUNSHAN) CO., LTD
 SHINWHA ROAD, KUNJIA HI-TECH INDUSTRIAL PARK, KUN-SHAN,
 JIANG-SU, CHINA
 TEL: +86-512-57619396 FAX: +86-512-57619688
 E-mail: hul@tai-tech.com.tw

Office:
 北欣國際有限公司
 NORTH STAR INTERNATIONAL LIMITED
 TEL: +86-512-57619396 FAX: +86-512-57619688

Sales Dep.

APPROVED	CHECKED
管哲頌 Eric Kuan	林巧盈 Emily Lin

R&D Center

APPROVED	CHECKED	DRAWN
楊祥忠 Mikey Yang	詹偉特 Jack Chan	林宜蕙 Beryl Lin

Power Inductor

UHP201610NF-SERIES

1. Features

- This specification applies Low Profile Power Inductors.
- 100% Lead(Pb) & Halogen-Free and RoHS compliant.



2. Dimension

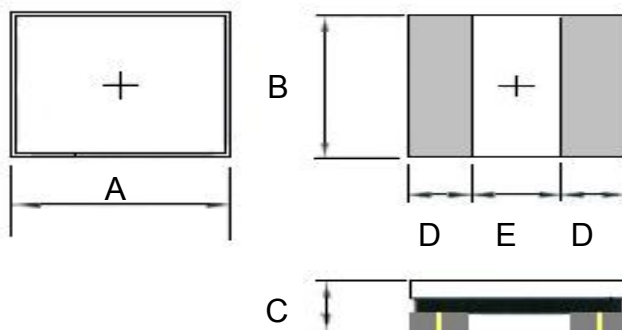

Series	A(mm)	B(mm)	C(mm)	D(mm)	E(mm)
UHP201610NF	2.0 -0.1/+0.2	1.6 -0.1/+0.2	1.0max.	0.60 ref.	0.80 ref.

Units: mm

3. Part Numbering

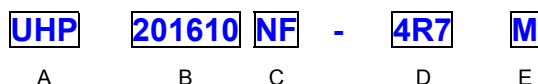

- A: Series
 B: Dimension
 C: Lead Free Material
 D: Inductance 4R7=4.7uH
 E: Inductance Tolerance M=±20% ; Y=±30%

4. Specification

TAI-TECH Part Number	Inductance (uH)	Tolerance (%)	Test Frequency (Hz)	DCR (Ω) ±20%	I sat (A) typ.	I sat (A) Max.	I rms (A) typ.	I rms (A) Max.
UHP201610NF-R47Y	0.47	±30%	0.1V/1M	0.044	3.00	2.70	2.60	2.35
UHP201610NF-R68Y	0.68	±30%	0.1V/1M	0.062	2.45	2.00	2.25	2.05
UHP201610NF-1R0Y	1.0	±30%	0.1V/1M	0.080	1.95	1.80	1.75	1.60
UHP201610NF-1R5Y	1.5	±30%	0.1V/1M	0.130	1.65	1.46	1.40	1.26
UHP201610NF-2R2M	2.2	±20%	0.1V/1M	0.145	1.45	1.26	1.35	1.20
UHP201610NF-3R3M	3.3	±20%	0.1V/1M	0.245	1.05	0.90	1.05	0.95
UHP201610NF-4R7M	4.7	±20%	0.1V/1M	0.360	0.85	0.77	1.00	0.90
UHP201610NF-6R8M	6.8	±20%	0.1V/1M	0.500	0.80	0.72	0.70	0.55
UHP201610NF-100M	10	±20%	0.1V/1M	0.720	0.62	0.55	0.50	0.45
UHP201610NF-150M	15	±20%	0.1V/1M	1.400	0.50	0.45	0.40	0.36
UHP201610NF-180M	18	±20%	0.1V/1M	1.800	0.45	0.40	0.38	0.34
UHP201610NF-220M	22	±20%	0.1V/1M	2.000	0.43	0.38	0.30	0.27

Note:

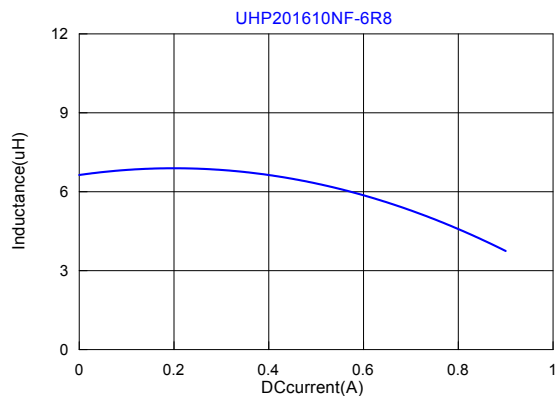
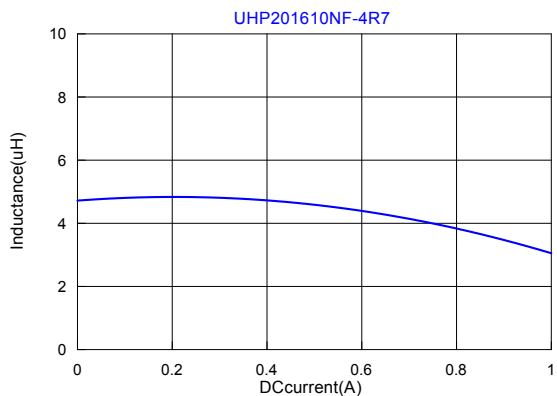
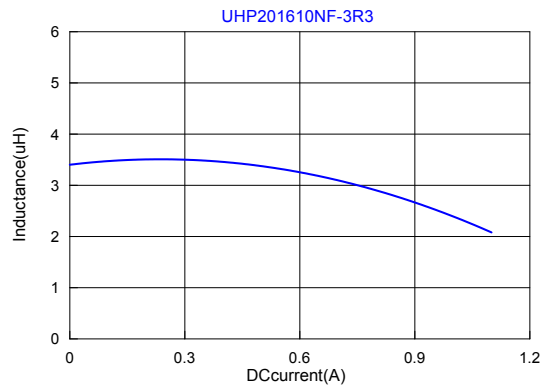
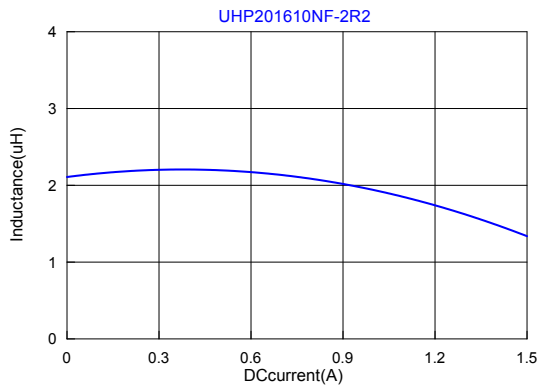
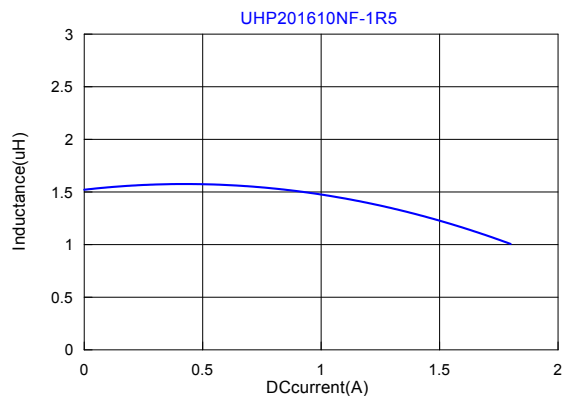
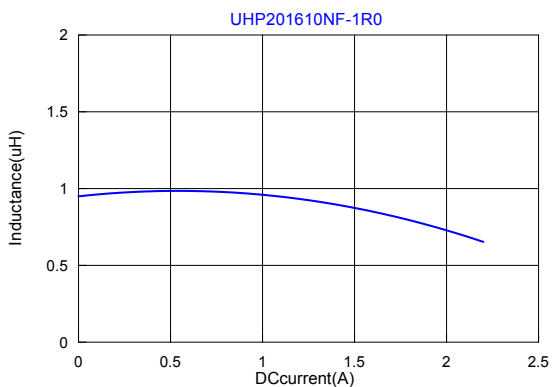
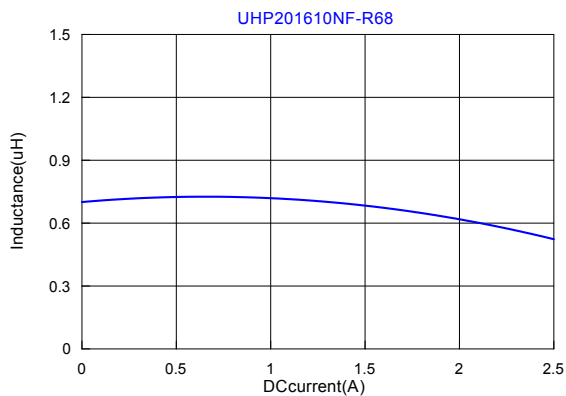
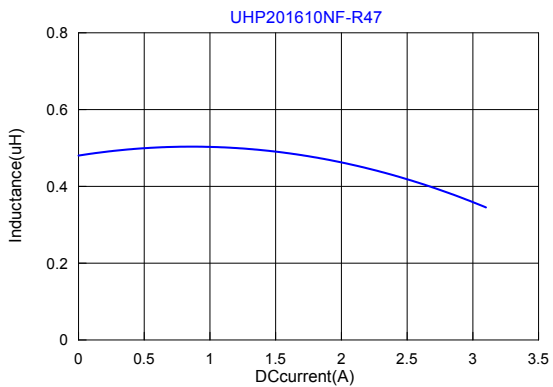

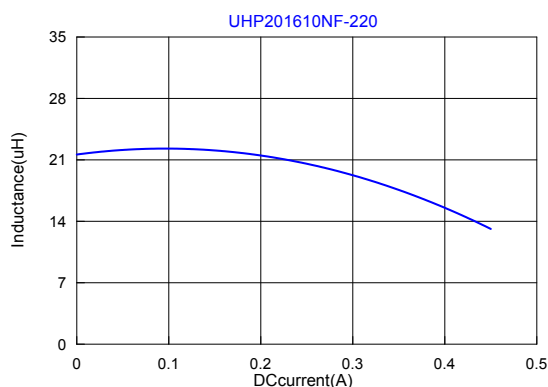
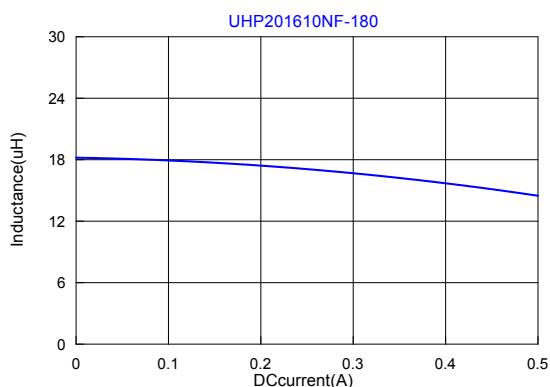
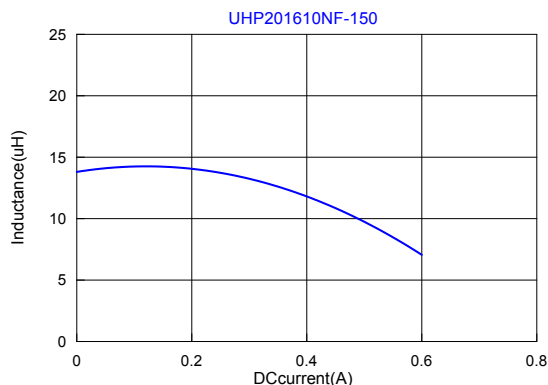
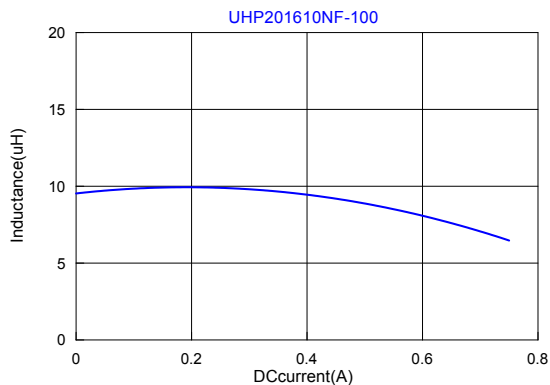

Void appearance tolerance Limit

Size of voids occurring to coating resin is specified below.

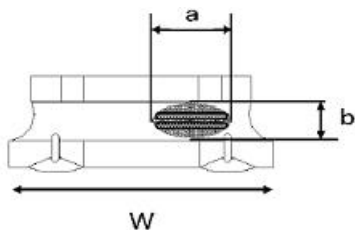

Exposed wire tolerance limit of coating resin part on product side.

Size of exposed wire occurring to coating resin is specified below.

1. Width direction (dimension a) : Acceptable when $a \leq w/2$
Nonconforming when $a > w/2$
2. Length direction (dimension b) : Dimension b is not specified.
3. The total area of exposed wire occurring to each sides is not greater than 50% of coating resin area, and is acceptable.

External appearance criterion for exposed wire

Exposed end of the winding wire at the secondary side should be 2mm and below.

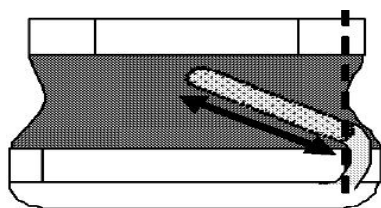

5. Material

No.	Description	Specification
a.	Core	Ferrite Core
b.	Coating	Epoxy with magnetic powder
c.	Termination	Tin (Pb Free)
d.	Wire	Enameled Copper Wire

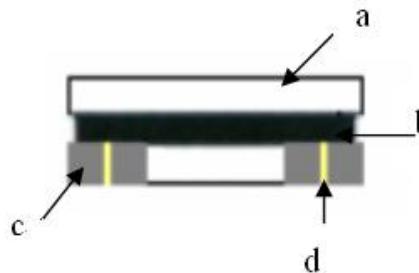

6. Reliability and Test Condition

Item	Performance	Test Condition								
Operating Temperature	-40~+125°C									
Storage Temperature (on board)										
Electrical Performance Test										
Inductance L	Refer to standard electrical characteristic list	Agilent-4291, Agilent-4287								
DC Resistance		Agilent-4338								
Rated Current	Base on temp. rise & $\Delta L/L0A \leq 30\%$.	Saturation DC Current (Isat) will cause L0 to drop approximately $\Delta L(\%)$.								
Temperature Rise Test	ΔT 40°C Max	Heat Rated Current (Irms) will cause the coil temperature rise approximately $\Delta T(^{\circ}C)$ without core loss. 1. Applied the allowed DC current. 2. Temperature measured by digital surface thermometer								
Mechanical Performance Test										
Solder Heat Resistance	Appearance : No damage. Inductance : within $\pm 10\%$ of initial value RDC : within $\pm 15\%$ of initial value and shall not exceed the specification value	<table border="1"> <thead> <tr> <th>Temperature (°C)</th> <th>Time (s)</th> <th>Temperature ramp/immersion and emersion rate</th> <th>Number of heat cycles</th> </tr> </thead> <tbody> <tr> <td>260 ± 5 (solder temp)</td> <td>10 ± 1</td> <td>25mm/s ± 6 mm/s</td> <td>1</td> </tr> </tbody> </table>	Temperature (°C)	Time (s)	Temperature ramp/immersion and emersion rate	Number of heat cycles	260 ± 5 (solder temp)	10 ± 1	25mm/s ± 6 mm/s	1
		Temperature (°C)	Time (s)	Temperature ramp/immersion and emersion rate	Number of heat cycles					
260 ± 5 (solder temp)	10 ± 1	25mm/s ± 6 mm/s	1							
Depth: completely cover the termination										

Item	Performance	Test Condition
Solderability Test	More than 95% of terminal electrode should be covered with solder.	Preheat: 150°C, 60sec. ° Solder: Sn99.5%-Cu0. 5% ° Temperature: 245±5°C ° Flux for lead free: Rosin. 9.5% ° Dip time: 4±1sec ° Depth: completely cover the termination
Reliability Test		
Life Test	Appearance : No damage. Inductance : within±10% of initial value RDC : within ±15% of initial value and shall not exceed the specification value	<u>Preconditioning:Run through IR reflow for 2 times.(IPC/JEDEC J-STD-020DClassification Reflow Profiles</u> Temperature : 125±2°C (Bead) Temperature : 85±2°C (Inductor) Applied current : rated current Duration : 1000±12hrs Measured at room temperature after placing for 24±2 hrs
Thermal shock		<u>Preconditioning:Run through IR reflow for 2 times.(IPC/JEDEC J-STD-020DClassification Reflow Profiles</u> Step1 : -40±2°C 30±5min Step2 : 25±2°C ≤0.5min Step3 : 105±2°C 30±5min Number of cycles : 500 Measured at room femprature after placing for 24±2 hrs
Humidity Resistance Test		<u>Preconditioning:Run through IR reflow for 2 times.(IPC/JEDEC J-STD-020DClassification Reflow Profiles</u> Humidity : 85±2% R.H, Temperature : 85°C ±2°C Duration : 1000hrs Min. with 100% rated current Measured at room temperature after placing for 24±2 hrs
Vibration Test		<u>Preconditioning:Run through IR reflow for 2 times.(IPC/JEDEC J-STD-020DClassification Reflow Profiles</u> Oscillation Frequency: 10~2K~10Hz for 20 minutes Equipment : Vibration checker Total Amplitude:1.52mm±10% Testing Time : 12 hours(20 minutes, 12 cycles each of 3 orientations) °

7. Soldering and Mounting

7-1. Soldering

Mildly activated rosin fluxes are preferred. TAI-TECH terminations are suitable for all wave and re-flow soldering systems. If hand soldering cannot be avoided, the preferred technique is the utilization of hot air soldering tools.

7-1.1 Solder re-flow:

Recommended temperature profiles for re-flow soldering in Figure 1.

7-1.2 Soldering Iron(Figure 2):

Products attachment with a soldering iron is discouraged due to the inherent process control limitations. In the event that a soldering iron must be employed the following precautions are recommended.

- Preheat circuit and products to 150°C
- Never contact the ceramic with the iron tip
- Use a 20 watt soldering iron with tip diameter of 1.0mm
- 355°C tip temperature (max)
- 1.0mm tip diameter (max)
- Limit soldering time to 4~5 sec.

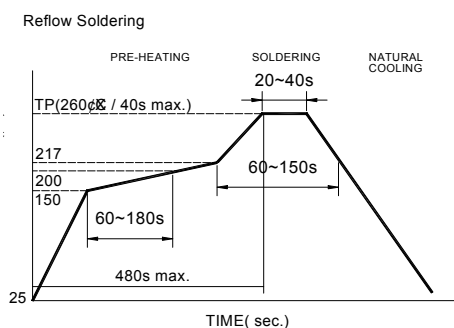

Reflow times: 3 times max.

Fig.1

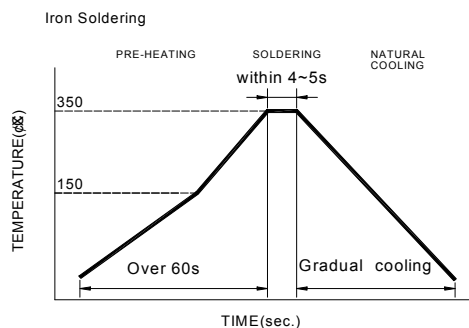

Iron Soldering times: 1 times max.

Fig.2

7-2. Recommended PC Board Pattern

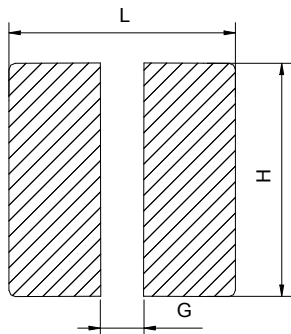

L(mm)	G(mm)	H(mm)
2.3	0.7	1.7

8. Packaging Information

8-1. Reel Dimension

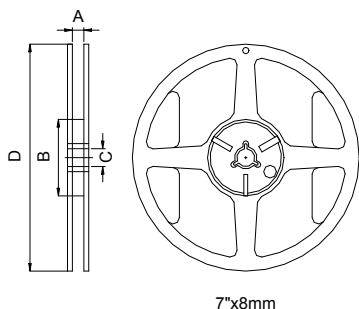

7"x8mm

Type	A(mm)	B(mm)	C(mm)	D(mm)
7"x8mm	8.4±1.0	50 min.	13±0.8	178±2

8-2. Tape Dimension / 8mm

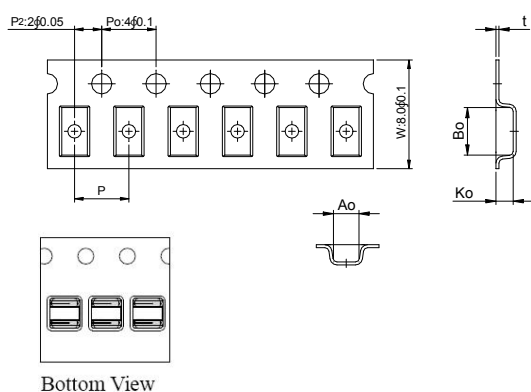

Bottom View

Series	Size	Bo(mm)	Ao(mm)	Ko(mm)	P(mm)	t(mm)
UHP	201610	2.5±0.10	2.0±0.10	1.05±0.10	4.0±0.10	0.23±0.05

8-3. Packaging Quantity

Chip size	201610
Chip / Reel	2000

8-4. Tearing Off Force

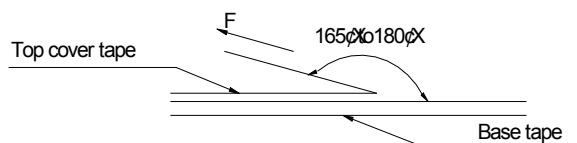

The force for tearing off cover tape is 15 to 80 grams in the arrow direction under the following conditions.

Room Temp. (°C)	Room Humidity (%)	Room atm (hPa)	Tearing Speed mm/min
5~35	45~85	860~1060	300

Application Notice

- Storage Conditions(component level)
 - To maintain the solderability of terminal electrodes:
 1. TAI-TECH products meet IPC/JEDEC J-STD-020D standard-MSL, level 1.
 2. Temperature and humidity conditions: Less than 40°C and 60% RH.
 3. Recommended products should be used within 12 months form the time of delivery.
 4. The packaging material should be kept where no chlorine or sulfur exists in the air.
- Transportation
 1. Products should be handled with care to avoid damage or contamination from perspiration and skin oils.
 2. The use of tweezers or vacuum pick up is strongly recommended for individual components.
 3. Bulk handling should ensure that abrasion and mechanical shock are minimized.

单击下面可查看定价，库存，交付和生命周期等信息

[>>TAI-TECH\(台庆\)](#)

[>>点击查看相关商品](#)