

Notice for TAIYO YUDEN products

Please read this notice before using the TAIYO YUDEN products.

REMINDERS

- Product information in this catalog is as of October 2012. All of the contents specified herein are subject to change without notice due to technical improvements, etc. Therefore, please check for the latest information carefully before practical application or usage of the Products.

Please note that Taiyo Yuden Co., Ltd. shall not be responsible for any defects in products or equipment incorporating such products, which are caused under the conditions other than those specified in this catalog or individual specification.

- Please contact Taiyo Yuden Co., Ltd. for further details of product specifications as the individual specification is available.
- Please conduct validation and verification of products in actual condition of mounting and operating environment before commercial shipment of the equipment.
- All electronic components or functional modules listed in this catalog are developed, designed and intended for use in general electronics equipment.(for AV, office automation, household, office supply, information service, telecommunications, (such as mobile phone or PC) etc.). Before incorporating the components or devices into any equipment in the field such as transportation,(automotive control, train control, ship control), transportation signal, disaster prevention, medical, public information network (telephone exchange, base station) etc. which may have direct influence to harm or injure a human body, please contact Taiyo Yuden Co., Ltd. for more detail in advance. Do not incorporate the products into any equipment in fields such as aerospace, aviation, nuclear control, submarine system, military, etc. where higher safety and reliability are especially required.

In addition, even electronic components or functional modules that are used for the general electronic equipment, if the equipment or the electric circuit require high safety or reliability function or performances, a sufficient reliability evaluation check for safety shall be performed before commercial shipment and moreover, due consideration to install a protective circuit is strongly recommended at customer's design stage.

- The contents of this catalog are applicable to the products which are purchased from our sales offices or distributors (so called "TAIYO YUDEN' s official sales channel").
It is only applicable to the products purchased from any of TAIYO YUDEN' s official sales channel.
- Please note that Taiyo Yuden Co., Ltd. shall have no responsibility for any controversies or disputes that may occur in connection with a third party's intellectual property rights and other related rights arising from your usage of products in this catalog. Taiyo Yuden Co., Ltd. grants no license for such rights.

■ Caution for export

Certain items in this catalog may require specific procedures for export according to "Foreign Exchange and Foreign Trade Control Law" of Japan, "U.S. Export Administration Regulations", and other applicable regulations. Should you have any question or inquiry on this matter, please contact our sales staff.

MULTILAYER CERAMIC CAPACITORS

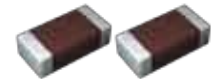

WAVE

REFLOW

PARTS NUMBER

J	M	K	3	1	6	△	B	J	1	0	6	M	L	-	T	△
①	②	③	④	⑤	⑥	⑦	⑧	⑨	⑩	⑪	⑫					

△ = Blank space

① Rated voltage

Code	Rated voltage [VDC]
P	2.5
A	4
J	6.3
L	10
E	16
T	25
G	35
U	50
H	100
Q	250
S	630

③ End termination

Code	End termination
K	Plated
R	High Reliability Application

② Series name

Code	Series name
M	Multilayer ceramic capacitor
V	Multilayer ceramic capacitor for high frequency
W	LW reverse type multilayer capacitor

④ Dimension (L × W)

Type	Dimensions (L × W) [mm]	EIA (inch)
042	0.4 × 0.2	01005
063	0.6 × 0.3	0201
105	1.0 × 0.5	0402
	0.52 × 1.0 ※	0204
107	1.6 × 0.8	0603
	0.8 × 1.6 ※	0306
212	2.0 × 1.25	0805
	1.25 × 2.0 ※	0508
316	3.2 × 1.6	1206
325	3.2 × 2.5	1210
432	4.5 × 3.2	1812

Note : ※LW reverse type (□WK) only

⑤ Dimension tolerance

Code	Type	L [mm]	W [mm]	T [mm]
△	ALL	Standard	Standard	Standard
A	063	0.6 ± 0.05	0.3 ± 0.05	0.3 ± 0.05
	105	1.0 ± 0.10	0.5 ± 0.10	0.5 ± 0.10
	107	1.6 + 0.15 / - 0.05	0.8 + 0.15 / - 0.05	0.8 + 0.15 / - 0.05
	212	2.0 + 0.15 / - 0.05	1.25 + 0.15 / - 0.05	0.45 ± 0.05 0.85 ± 0.10 1.25 + 0.15 / - 0.05
	316	3.2 ± 0.20	1.25 ± 0.20	0.85 ± 0.10 1.6 ± 0.20
B	325	3.2 ± 0.30	2.5 ± 0.30	2.5 ± 0.30
	105	1.0 + 0.15 / - 0.05	0.5 + 0.15 / - 0.05	0.5 + 0.15 / - 0.05
	107	1.6 + 0.20 / - 0	0.8 + 0.20 / - 0	0.45 ± 0.05 0.8 + 0.20 / - 0
	212	2.0 + 0.20 / - 0	1.25 + 0.20 / - 0	0.85 ± 0.10 1.25 + 0.20 / - 0
C	316	3.2 ± 0.30	1.6 ± 0.30	1.6 ± 0.30
	105	1.0 + 0.20 / - 0	0.5 + 0.20 / - 0	0.5 + 0.20 / - 0

Note: P.6 Standard external dimensions

△ = Blank space

⑥ Temperature characteristics code

■ High dielectric type (Excluding Super low distortion multilayer ceramic capacitor (FCAP™))

Code	Applicable standard	Temperature range [°C]	Ref. Temp. [°C]	Capacitance change	Capacitance tolerance	Tolerance code
BJ	JIS B	-25 ~ + 85	20	± 10%	± 10% ± 20%	K M
	EIA X5R	-55 ~ + 85	25	± 15%	± 10% ± 20%	K M
B7	EIA X7R	-55 ~ + 125	25	± 15%	± 10% ± 20%	K M
C6	EIA X6S	-55 ~ + 105	25	± 22%	± 10% ± 20%	K M
C7	EIA X7S	-55 ~ + 125	25	± 22%	± 10% ± 20%	K M
LD(※)	EIA X5R	-55 ~ + 85	25	± 15%	± 10% ± 20%	K M
△F	JIS F	-25 ~ + 85	20	+30 / -80%	+80 / -20%	Z
	EIA Y5V	-30 ~ + 85	25	+22 - 82%	+80 / -20%	Z

Note : ※LD Low distortion high value multilayer ceramic capacitor

△ = Blank space

■ Temperature compensating type

Code	Applicable standard		Temperature range [°C]	Ref. Temp. [°C]	Capacitance change	Capacitance tolerance	Tolerance code
CH	JIS	CH	-55 ~ +125	20	0 ± 60ppm/°C	±0.1pF	B
		C0H				±0.25pF	C
	EIA	±0.5pF		D			
		1pF		F			
		±5%		J			
±10%	K						
CJ	JIS	CJ	-55 ~ +125	20	0 ± 120ppm/°C	±0.25pF	C
	EIA	C0J		25			
CK	JIS	CK	-55 ~ +125	20	0 ± 250ppm/°C	±0.25pF	C
	EIA	C0K		25			
UJ	JIS	UJ	-55 ~ +125	20	-750 ± 120ppm/°C	±0.25pF	C
	EIA	U2J		25		±0.5pF	D
±5%			J				
UK	JIS	UK	-55 ~ +125	20	-750 ± 250ppm/°C	±0.5pF	C
	EIA	U2K	-55 ~ +125	25			
SL	JIS	S	-55 ~ +125	20	+350 ~ -1000ppm/°C	±5%	J

⑥ Series code

(Super low distortion multilayer ceramic capacitor (CFCAP™) only)

Code	Series code
SD	Standard

⑦ Nominal capacitance

Code (example)	Nominal capacitance
0R5	0.5pF
010	1pF
100	10pF
101	100p
102	1,000pF
103	10,000pF
104	0.1 μF
105	1.0 μF
106	10 μF
107	100 μF

Note : R=Decimal point

⑧ Capacitance tolerance

Code	Capacitance tolerance
B	±0.1pF
C	±0.25pF
D	±0.5pF
F	±1pF
J	±5%
K	±10%
M	±20%
Z	+80/-20%

⑨ Thickness

Code	Thickness [mm]
C	0.2
D	0.2(Temperature compensating of 042type)
P	0.3
T	
K	0.45
V	0.5
W	
A	0.8
D	0.85(212type or more)
F	1.15
G	1.25
L	1.6
N	1.9
Y	2.0 max
M	2.5

⑩ Special code

Code	Special code
-	Standard

⑪ Packaging

Code	Packaging
F	φ 178mm Taping (2mm pitch)
T	φ 178mm Taping (4mm pitch)
P	φ 178mm Taping (4mm pitch, 1000 pcs/reel) 325 type (Thickness code M)
W	φ 178mm Taping (1mm pitch) 042type only

⑫ Internal code

Code	Internal code
Δ	Standard

STANDARD EXTERNAL DIMENSIONS

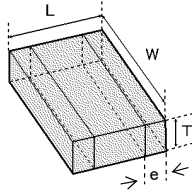
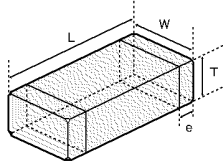

※ LW reverse type

Type(EIA)	Dimension [mm]				
	L	W	T	*1	e
□MK042(01005)	0.4±0.02	0.2±0.02	0.2±0.02	C D	0.1±0.03
□MK063(0201)	0.6±0.03	0.3±0.03	0.3±0.03	P T	0.15±0.05
□MK105(0402)	1.0±0.05	0.5±0.05	0.2±0.02	C	0.25±0.10
			0.3±0.03	P	
			0.5±0.05	V	
□VK105(0402)	1.0±0.05	0.5±0.05	0.5±0.05	W	0.25±0.10
□WK105(0204)※	0.52±0.05	1.0±0.05	0.3±0.05	P	0.18±0.08
□MK107(0603)	1.6±0.10	0.8±0.10	0.45±0.05	K	0.35±0.25
			0.8±0.10	A	
□MR107(0603)	1.6±0.10	0.8±0.10	0.8±0.10	A	0.1~0.6
□WK107(0306)※	0.8±0.10	1.6±0.10	0.5±0.05	V	0.25±0.15
			0.45±0.05	K	
			0.85±0.10	D	
□MK212(0805)	2.0±0.10	1.25±0.10	1.25±0.10	G	0.5±0.25
			0.85±0.10	D	
□MR212(0805)	2.0±0.10	1.25±0.10	1.25±0.10	G	0.25~0.75
□WK212(0508)※	1.25±0.15	2.0±0.15	0.85±0.1	D	0.3±0.2
			0.85±0.10	D	
			1.15±0.10	F	
			1.25±0.10	G	
□MK316(1206)	3.2±0.15	1.6±0.15	1.6±0.20	L	0.5+0.35/-0.25
			1.25±0.10	G	
			1.15±0.10	F	
			1.6±0.20	L	
□MR316(1206)	3.2±0.15	1.6±0.15	1.6±0.20	L	0.25~0.85
□MK325(1210)	3.2±0.30	2.5±0.20	0.85±0.10	D	0.6±0.3
			1.15±0.10	F	
			1.9±0.20	N	
			1.9+0.1/-0.2	Y	
			2.5±0.20	M	
□MR325(1210)	3.2±0.30	2.5±0.20	1.9±0.20	N	0.3~0.9
			2.5±0.20	M	
□MK432(1812)	4.5±0.40	3.2±0.30	2.5±0.20	M	0.9±0.6

Note : ※. LW reverse type, *1.Thickness code

STANDARD QUANTITY

Type	EIA (inch)	Dimension		Standard quantity [pcs]			
		[mm]	Code	Paper tape	Embossed tape		
042	01005	0.2	C	—	40000		
			D				
063	0201	0.3	P	15000	—		
			T				
105	0402	0.2	C	20000	—		
			P	15000	—		
		0.5	V	10000	—		
			W				
0204 ※	P						
107	0603	0.45	K	4000	—		
		0.8	A				
		0306 ※	V			—	4000
212	0805	0.45	K	4000	—		
		0.85	D				
		1.25	G			—	3000
		0508 ※	D			4000	—
316	1206	0.85	D	4000	—		
		1.15	F	—	3000		
		1.25	G	—	2000		
		1.6	L	—	2000		
325	1210	0.85	D	—	2000		
		1.15	F				
		1.9	N				
		2.0 max	Y				
		2.5	M				
432	1812	2.5	M	—	500(T), 1000(P)		
			M	—	500		

Note : ※.LW Reverse type(□WK)

▶ This catalog contains the typical specification only due to the limitation of space. When you consider the purchase of our products, please check our specification. For details of each product (characteristics graph, reliability information, precautions for use, and so on), see our Web site (<http://www.ty-top.com/>).

PARTS NUMBER

[Temperature Characteristic BJ : B/X5R] 0.85mm thickness(D)

Part number 1	Part number 2	Rated voltage [V]	Temperature characteristics		Capacitance [F]	Capacitance tolerance [%]	tan δ [%]	HALT	Thickness*3 [mm]	Soldering R:Reflow W:Wave
								Rated voltage x %		
TMK325 BJ106[D-T		25	B	X5R	10 μ	±10, ±20	5	150	0.85±0.10	R
EMK325 BJ106[D-T		16	B	X5R	10 μ	±10, ±20	5	150	0.85±0.10	R
EMK325 BJ226MD-T			B	X5R	22 μ	±20	10	150	0.85±0.10	R
LMK325 BJ335[D-T		10	B	X5R	3.3 μ	±10, ±20	3.5	200	0.85±0.10	R
LMK325 BJ475[D-T			B	X5R	4.7 μ	±10, ±20	5	200	0.85±0.10	R
LMK325 BJ106[D-T			B	X5R	10 μ	±10, ±20	5	150	0.85±0.10	R

[Temperature Characteristic C6 : X6S] 2.5mm thickness(M)

Part number 1	Part number 2	Rated voltage [V]	Temperature characteristics		Capacitance [F]	Capacitance tolerance [%]	tan δ [%]	HALT	Thickness*3 [mm]	Soldering R:Reflow W:Wave
								Rated voltage x %		
JMK325AC6107MM-T		6.3		X6S	100 μ	±20	10	150	2.5±0.30	R

[Temperature Characteristic B7 : X7R] 2.5mm thickness(M)

Part number 1	Part number 2	Rated voltage [V]	Temperature characteristics		Capacitance [F]	Capacitance tolerance [%]	tan δ [%]	HALT	Thickness*3 [mm]	Soldering R:Reflow W:Wave
								Rated voltage x %		
UMK325 B7475[M-T		50		X7R	4.7 μ	±10, ±20	5	150	2.5±0.20	R
UMK325AB7106[M-T					X7R	10 μ	±10, ±20	10	150	2.5±0.30
TMK325AB7106MM-T		25		X7R	10 μ	±20	10	150	2.5±0.30	R
TMK325 B7226[M-TR					X7R	22 μ	±10, ±20	10	150	2.5±0.20
EMK325 B7226[M-TR		16		X7R	22 μ	±10, ±20	10	150	2.5±0.20	R
LMK325 B7476[M-TR		10		X7R	47 μ	±10, ±20	10	150	2.5±0.20	R
JMK325 B7476[M-TR		6.3		X7R	47 μ	±10, ±20	10	200	2.5±0.20	R

[Temperature Characteristic B7 : X7R] 1.9mm thickness(N)

Part number 1	Part number 2	Rated voltage [V]	Temperature characteristics		Capacitance [F]	Capacitance tolerance [%]	tan δ [%]	HALT	Thickness*3 [mm]	Soldering R:Reflow W:Wave	
								Rated voltage x %			
UMK325 B7475[N-TR		50		X7R	4.7 μ	±10, ±20	10	150	1.9±0.20	R	
TMK325 B7335[N-T		25		X7R	3.3 μ	±10, ±20	3.5	200	1.9±0.20	R	
TMK325 B7475[N-T					X7R	4.7 μ	±10, ±20	3.5	150	1.9±0.20	R
TMK325 B7106[N-TR		16		X7R	10 μ	±10, ±20	10	150	1.9±0.20	R	
EMK325 B7475[N-T					X7R	4.7 μ	±10, ±20	3.5	200	1.9±0.20	R
EMK325 B7106[N-T					X7R	10 μ	±10, ±20	3.5	150	1.9±0.20	R
LMK325 B7106[N-T		10		X7R	10 μ	±10, ±20	3.5	200	1.9±0.20	R	

[Temperature Characteristic F : F/Y5V] 1.9mm thickness(N)

Part number 1	Part number 2	Rated voltage [V]	Temperature characteristics		Capacitance [F]	Capacitance tolerance [%]	tan δ [%]	HALT	Thickness*3 [mm]	Soldering R:Reflow W:Wave
								Rated voltage x %		
EMK325 F226ZN-T		16	F	Y5V	22 μ	+80/-20	16	200	1.9±0.20	R
LMK325 F226ZN-T		10	F	Y5V	22 μ	+80/-20	16	200	1.9±0.20	R
JMK325 F476ZN-T		6.3	F	Y5V	47 μ	+80/-20	16	200	1.9±0.20	R

Multilayer Ceramic Capacitors (Temperature compensating type)

042TYPE

[Temperature Characteristic CΔ : CΔ/C0Δ] 0.2mm thickness(C,D)

Part number 1	Part number 2	Rated voltage [V]	Temperature characteristics		Capacitance [F]	Capacitance tolerance [%]	Q	HALT	Thickness*3 [mm]	Soldering R:Reflow W:Wave
								Rated voltage x %		
EMK042 CK0R4CD-W		16	CK	C0K	0.4 p	±0.25pF	408	200	0.2±0.02	R
EMK042 CK0R5CD-W			CK	C0K	0.5 p	±0.25pF	410	200	0.2±0.02	R
EMK042 CK0R6CD-W			CK	C0K	0.6 p	±0.25pF	412	200	0.2±0.02	R
EMK042 CK0R7CD-W			CK	C0K	0.7 p	±0.25pF	414	200	0.2±0.02	R
EMK042 CKR75CD-W			CK	C0K	0.75 p	±0.25pF	415	200	0.2±0.02	R
EMK042 CK0R8CD-W			CK	C0K	0.8 p	±0.25pF	416	200	0.2±0.02	R
EMK042 CK0R9CD-W			CK	C0K	0.9 p	±0.25pF	418	200	0.2±0.02	R
EMK042 CK010CD-W			CK	C0K	1 p	±0.25pF	420	200	0.2±0.02	R
EMK042 CK1R1CD-W			CK	C0K	1.1 p	±0.25pF	422	200	0.2±0.02	R
EMK042 CK1R2CD-W			CK	C0K	1.2 p	±0.25pF	424	200	0.2±0.02	R
EMK042 CK1R3CD-W			CK	C0K	1.3 p	±0.25pF	426	200	0.2±0.02	R
EMK042 CK1R4CD-W			CK	C0K	1.4 p	±0.25pF	428	200	0.2±0.02	R
EMK042 CK1R5CD-W			CK	C0K	1.5 p	±0.25pF	430	200	0.2±0.02	R
EMK042 CK1R6CD-W			CK	C0K	1.6 p	±0.25pF	432	200	0.2±0.02	R
EMK042 CK1R7CD-W			CK	C0K	1.7 p	±0.25pF	434	200	0.2±0.02	R
EMK042 CK1R8CD-W			CK	C0K	1.8 p	±0.25pF	436	200	0.2±0.02	R
EMK042 CK1R9CD-W			CK	C0K	1.9 p	±0.25pF	438	200	0.2±0.02	R
EMK042 CK020CD-W			CK	C0K	2 p	±0.25pF	440	200	0.2±0.02	R
EMK042 CK2R1CD-W			CK	C0K	2.1 p	±0.25pF	442	200	0.2±0.02	R
EMK042 CK2R2CD-W			CK	C0K	2.2 p	±0.25pF	444	200	0.2±0.02	R
EMK042 CK2R3CD-W			CK	C0K	2.3 p	±0.25pF	446	200	0.2±0.02	R
EMK042 CK2R4CD-W			CK	C0K	2.4 p	±0.25pF	448	200	0.2±0.02	R
EMK042 CK2R5CD-W			CK	C0K	2.5 p	±0.25pF	450	200	0.2±0.02	R
EMK042 CK2R6CD-W			CK	C0K	2.6 p	±0.25pF	452	200	0.2±0.02	R
EMK042 CK2R7CD-W			CK	C0K	2.7 p	±0.25pF	454	200	0.2±0.02	R
EMK042 CK2R8CD-W			CK	C0K	2.8 p	±0.25pF	456	200	0.2±0.02	R
EMK042 CK2R9CD-W			CK	C0K	2.9 p	±0.25pF	458	200	0.2±0.02	R
EMK042 CJ030CD-W			CJ	C0J	3 p	±0.25pF	460	200	0.2±0.02	R
EMK042 CJ3R1CD-W			CJ	C0J	3.1 p	±0.25pF	462	200	0.2±0.02	R
EMK042 CJ3R2CD-W			CJ	C0J	3.2 p	±0.25pF	464	200	0.2±0.02	R
EMK042 CJ3R3CD-W			CJ	C0J	3.3 p	±0.25pF	466	200	0.2±0.02	R
EMK042 CJ3R4CD-W			CJ	C0J	3.4 p	±0.25pF	468	200	0.2±0.02	R
EMK042 CJ3R5CD-W			CJ	C0J	3.5 p	±0.25pF	470	200	0.2±0.02	R
EMK042 CJ3R6CD-W			CJ	C0J	3.6 p	±0.25pF	472	200	0.2±0.02	R
EMK042 CJ3R7CD-W			CJ	C0J	3.7 p	±0.25pF	474	200	0.2±0.02	R
EMK042 CJ3R8CD-W			CJ	C0J	3.8 p	±0.25pF	476	200	0.2±0.02	R
EMK042 CJ3R9CD-W			CJ	C0J	3.9 p	±0.25pF	478	200	0.2±0.02	R

► This catalog contains the typical specification only due to the limitation of space. When you consider the purchase of our products, please check our specification. For details of each product (characteristics graph, reliability information, precautions for use, and so on), see our Web site (<http://www.ty-top.com/>).

Part number 1	Part number 2	Rated voltage [V]	Temperature characteristics		Capacitance [F]	Capacitance tolerance [%]	Q	HALT	Thickness*3 [mm]	Soldering R:Reflow W:Wave
								Rated voltage x %		
EMK042 CH040CD-W		16	CH	C0H	4 p	±0.25pF	480	200	0.2±0.02	R
EMK042 CH4R1CD-W			CH	C0H	4.1 p	±0.25pF	482	200	0.2±0.02	R
EMK042 CH4R2CD-W			CH	C0H	4.2 p	±0.25pF	484	200	0.2±0.02	R
EMK042 CH4R3CD-W			CH	C0H	4.3 p	±0.25pF	486	200	0.2±0.02	R
EMK042 CH4R4CD-W			CH	C0H	4.4 p	±0.25pF	488	200	0.2±0.02	R
EMK042 CH4R5CD-W			CH	C0H	4.5 p	±0.25pF	490	200	0.2±0.02	R
EMK042 CH4R6CD-W			CH	C0H	4.6 p	±0.25pF	492	200	0.2±0.02	R
EMK042 CH4R7CD-W			CH	C0H	4.7 p	±0.25pF	494	200	0.2±0.02	R
EMK042 CH4R8CD-W			CH	C0H	4.8 p	±0.25pF	496	200	0.2±0.02	R
EMK042 CH4R9CD-W			CH	C0H	4.9 p	±0.25pF	498	200	0.2±0.02	R
EMK042 CH050CD-W			CH	C0H	5 p	±0.25pF	500	200	0.2±0.02	R
EMK042 CH5R1DD-W			CH	C0H	5.1 p	±0.5pF	502	200	0.2±0.02	R
EMK042 CH5R2DD-W			CH	C0H	5.2 p	±0.5pF	504	200	0.2±0.02	R
EMK042 CH5R3DD-W			CH	C0H	5.3 p	±0.5pF	506	200	0.2±0.02	R
EMK042 CH5R4DD-W			CH	C0H	5.4 p	±0.5pF	508	200	0.2±0.02	R
EMK042 CH5R5DD-W			CH	C0H	5.5 p	±0.5pF	510	200	0.2±0.02	R
EMK042 CH5R6DD-W			CH	C0H	5.6 p	±0.5pF	512	200	0.2±0.02	R
EMK042 CH5R7DD-W			CH	C0H	5.7 p	±0.5pF	514	200	0.2±0.02	R
EMK042 CH5R8DD-W			CH	C0H	5.8 p	±0.5pF	516	200	0.2±0.02	R
EMK042 CH5R9DD-W			CH	C0H	5.9 p	±0.5pF	518	200	0.2±0.02	R
EMK042 CH060DD-W			CH	C0H	6 p	±0.5pF	520	200	0.2±0.02	R
EMK042 CH6R1DD-W			CH	C0H	6.1 p	±0.5pF	522	200	0.2±0.02	R
EMK042 CH6R2DD-W			CH	C0H	6.2 p	±0.5pF	524	200	0.2±0.02	R
EMK042 CH6R3DD-W			CH	C0H	6.3 p	±0.5pF	526	200	0.2±0.02	R
EMK042 CH6R4DD-W			CH	C0H	6.4 p	±0.5pF	528	200	0.2±0.02	R
EMK042 CH6R5DD-W			CH	C0H	6.5 p	±0.5pF	530	200	0.2±0.02	R
EMK042 CH6R6DD-W			CH	C0H	6.6 p	±0.5pF	532	200	0.2±0.02	R
EMK042 CH6R7DD-W			CH	C0H	6.7 p	±0.5pF	534	200	0.2±0.02	R
EMK042 CH6R8DD-W			CH	C0H	6.8 p	±0.5pF	536	200	0.2±0.02	R
EMK042 CH6R9DD-W			CH	C0H	6.9 p	±0.5pF	538	200	0.2±0.02	R
EMK042 CH070DD-W			CH	C0H	7 p	±0.5pF	540	200	0.2±0.02	R
EMK042 CH7R1DD-W			CH	C0H	7.1 p	±0.5pF	542	200	0.2±0.02	R
EMK042 CH7R2DD-W			CH	C0H	7.2 p	±0.5pF	544	200	0.2±0.02	R
EMK042 CH7R3DD-W			CH	C0H	7.3 p	±0.5pF	546	200	0.2±0.02	R
EMK042 CH7R4DD-W			CH	C0H	7.4 p	±0.5pF	548	200	0.2±0.02	R
EMK042 CH7R5DD-W			CH	C0H	7.5 p	±0.5pF	550	200	0.2±0.02	R
EMK042 CH7R6DD-W			CH	C0H	7.6 p	±0.5pF	552	200	0.2±0.02	R
EMK042 CH7R7DD-W			CH	C0H	7.7 p	±0.5pF	554	200	0.2±0.02	R
EMK042 CH7R8DD-W			CH	C0H	7.8 p	±0.5pF	556	200	0.2±0.02	R
EMK042 CH7R9DD-W			CH	C0H	7.9 p	±0.5pF	558	200	0.2±0.02	R
EMK042 CH080DD-W			CH	C0H	8 p	±0.5pF	560	200	0.2±0.02	R
EMK042 CH8R1DD-W			CH	C0H	8.1 p	±0.5pF	562	200	0.2±0.02	R
EMK042 CH8R2DD-W			CH	C0H	8.2 p	±0.5pF	564	200	0.2±0.02	R
EMK042 CH8R3DD-W			CH	C0H	8.3 p	±0.5pF	566	200	0.2±0.02	R
EMK042 CH8R4DD-W			CH	C0H	8.4 p	±0.5pF	568	200	0.2±0.02	R
EMK042 CH8R5DD-W			CH	C0H	8.5 p	±0.5pF	570	200	0.2±0.02	R
EMK042 CH8R6DD-W			CH	C0H	8.6 p	±0.5pF	572	200	0.2±0.02	R
EMK042 CH8R7DD-W			CH	C0H	8.7 p	±0.5pF	574	200	0.2±0.02	R
EMK042 CH8R8DD-W			CH	C0H	8.8 p	±0.5pF	576	200	0.2±0.02	R
EMK042 CH8R9DD-W			CH	C0H	8.9 p	±0.5pF	578	200	0.2±0.02	R
EMK042 CH090DD-W			CH	C0H	9 p	±0.5pF	580	200	0.2±0.02	R
EMK042 CH9R1DD-W			CH	C0H	9.1 p	±0.5pF	582	200	0.2±0.02	R
EMK042 CH9R2DD-W			CH	C0H	9.2 p	±0.5pF	584	200	0.2±0.02	R
EMK042 CH9R3DD-W			CH	C0H	9.3 p	±0.5pF	586	200	0.2±0.02	R
EMK042 CH9R4DD-W			CH	C0H	9.4 p	±0.5pF	588	200	0.2±0.02	R
EMK042 CH9R5DD-W			CH	C0H	9.5 p	±0.5pF	590	200	0.2±0.02	R
EMK042 CH9R6DD-W			CH	C0H	9.6 p	±0.5pF	592	200	0.2±0.02	R
EMK042 CH9R7DD-W			CH	C0H	9.7 p	±0.5pF	594	200	0.2±0.02	R
EMK042 CH9R8DD-W			CH	C0H	9.8 p	±0.5pF	596	200	0.2±0.02	R
EMK042 CH9R9DD-W			CH	C0H	9.9 p	±0.5pF	598	200	0.2±0.02	R
EMK042 CH100DD-W			CH	C0H	10 p	±0.5pF	600	200	0.2±0.02	R
EMK042 CH110JD-W			CH	C0H	11 p	±5%	620	200	0.2±0.02	R
EMK042 CH120JD-W			CH	C0H	12 p	±5%	640	200	0.2±0.02	R
EMK042 CH130JD-W			CH	C0H	13 p	±5%	660	200	0.2±0.02	R
EMK042 CH150JD-W			CH	C0H	15 p	±5%	700	200	0.2±0.02	R
EMK042 CH160JC-W			CH	C0H	16 p	±5%	720	200	0.2±0.02	R
EMK042 CH180JC-W			CH	C0H	18 p	±5%	760	200	0.2±0.02	R
EMK042 CH200JC-W			CH	C0H	20 p	±5%	800	200	0.2±0.02	R
EMK042 CH220JC-W			CH	C0H	22 p	±5%	840	200	0.2±0.02	R
EMK042 CH240JC-W			CH	C0H	24 p	±5%	880	200	0.2±0.02	R
EMK042 CH270JC-W			CH	C0H	27 p	±5%	940	200	0.2±0.02	R
EMK042 CH300JC-W			CH	C0H	30 p	±5%	1000	200	0.2±0.02	R
EMK042 CH330JC-W			CH	C0H	33 p	±5%	1000	200	0.2±0.02	R
EMK042 CH360JC-W			CH	C0H	36 p	±5%	1000	200	0.2±0.02	R
EMK042 CH390JC-W			CH	C0H	39 p	±5%	1000	200	0.2±0.02	R
EMK042 CH430JC-W			CH	C0H	43 p	±5%	1000	200	0.2±0.02	R
EMK042 CH470JC-W			CH	C0H	47 p	±5%	1000	200	0.2±0.02	R
EMK042 CH510JC-W			CH	C0H	51 p	±5%	1000	200	0.2±0.02	R
EMK042 CH560JC-W			CH	C0H	56 p	±5%	1000	200	0.2±0.02	R
EMK042 CH620JC-W			CH	C0H	62 p	±5%	1000	200	0.2±0.02	R
EMK042 CH680JC-W			CH	C0H	68 p	±5%	1000	200	0.2±0.02	R
EMK042 CH750JC-W			CH	C0H	75 p	±5%	1000	200	0.2±0.02	R
EMK042 CH820JC-W			CH	C0H	82 p	±5%	1000	200	0.2±0.02	R
EMK042 CH910JC-W			CH	C0H	91 p	±5%	1000	200	0.2±0.02	R
EMK042 CH101JC-W			CH	C0H	100 p	±5%	1000	200	0.2±0.02	R

▶ This catalog contains the typical specification only due to the limitation of space. When you consider the purchase of our products, please check our specification. For details of each product (characteristics graph, reliability information, precautions for use, and so on), see our Web site (<http://www.ty-top.com/>).

● 063TYPE

[Temperature Characteristic CΔ : CΔ/C0Δ] 0.3mm thickness (T)

Part number 1	Part number 2	Rated voltage [V]	Temperature characteristics		Capacitance [F]	Capacitance tolerance [%]	Q	HALT	Thickness*3 [mm]	Soldering R:Reflow W:Wave
								Rated voltage x %		
UMK063 CK0R2CT-F		50	CK	C0K	0.2 p	±0.25pF	404	200	0.3±0.03	R
UMK063 CK0R3CT-F			CK	C0K	0.3 p	±0.25pF	406	200	0.3±0.03	R
UMK063 CK0R4CT-F			CK	C0K	0.4 p	±0.25pF	408	200	0.3±0.03	R
UMK063 CK0R5CT-F			CK	C0K	0.5 p	±0.25pF	410	200	0.3±0.03	R
UMK063 CK0R6CT-F			CK	C0K	0.6 p	±0.25pF	412	200	0.3±0.03	R
UMK063 CK0R7CT-F			CK	C0K	0.7 p	±0.25pF	414	200	0.3±0.03	R
UMK063 CKR75CT-F			CK	C0K	0.75 p	±0.25pF	415	200	0.3±0.03	R
UMK063 CK0R8CT-F			CK	C0K	0.8 p	±0.25pF	416	200	0.3±0.03	R
UMK063 CK0R9CT-F			CK	C0K	0.9 p	±0.25pF	418	200	0.3±0.03	R
UMK063 CK010CT-F			CK	C0K	1 p	±0.25pF	420	200	0.3±0.03	R
UMK063 CK1R1CT-F			CK	C0K	1.1 p	±0.25pF	422	200	0.3±0.03	R
UMK063 CK1R2CT-F			CK	C0K	1.2 p	±0.25pF	424	200	0.3±0.03	R
UMK063 CK1R3CT-F			CK	C0K	1.3 p	±0.25pF	426	200	0.3±0.03	R
UMK063 CK1R4CT-F			CK	C0K	1.4 p	±0.25pF	428	200	0.3±0.03	R
UMK063 CK1R5CT-F			CK	C0K	1.5 p	±0.25pF	430	200	0.3±0.03	R
UMK063 CK1R6CT-F			CK	C0K	1.6 p	±0.25pF	432	200	0.3±0.03	R
UMK063 CK1R7CT-F			CK	C0K	1.7 p	±0.25pF	434	200	0.3±0.03	R
UMK063 CK1R8CT-F			CK	C0K	1.8 p	±0.25pF	436	200	0.3±0.03	R
UMK063 CK1R9CT-F			CK	C0K	1.9 p	±0.25pF	438	200	0.3±0.03	R
UMK063 CK020CT-F			CK	C0K	2 p	±0.25pF	440	200	0.3±0.03	R
UMK063 CK2R1CT-F			CK	C0K	2.1 p	±0.25pF	442	200	0.3±0.03	R
UMK063 CK2R2CT-F			CK	C0K	2.2 p	±0.25pF	444	200	0.3±0.03	R
UMK063 CK2R3CT-F			CK	C0K	2.3 p	±0.25pF	446	200	0.3±0.03	R
UMK063 CK2R4CT-F			CK	C0K	2.4 p	±0.25pF	448	200	0.3±0.03	R
UMK063 CK2R5CT-F			CK	C0K	2.5 p	±0.25pF	450	200	0.3±0.03	R
UMK063 CK2R6CT-F			CK	C0K	2.6 p	±0.25pF	452	200	0.3±0.03	R
UMK063 CK2R7CT-F			CK	C0K	2.7 p	±0.25pF	454	200	0.3±0.03	R
UMK063 CK2R8CT-F			CK	C0K	2.8 p	±0.25pF	456	200	0.3±0.03	R
UMK063 CK2R9CT-F			CK	C0K	2.9 p	±0.25pF	458	200	0.3±0.03	R
UMK063 CJ030CT-F			CJ	C0J	3 p	±0.25pF	460	200	0.3±0.03	R
UMK063 CJ3R1CT-F			CJ	C0J	3.1 p	±0.25pF	462	200	0.3±0.03	R
UMK063 CJ3R2CT-F			CJ	C0J	3.2 p	±0.25pF	464	200	0.3±0.03	R
UMK063 CJ3R3CT-F			CJ	C0J	3.3 p	±0.25pF	466	200	0.3±0.03	R
UMK063 CJ3R4CT-F			CJ	C0J	3.4 p	±0.25pF	468	200	0.3±0.03	R
UMK063 CJ3R5CT-F			CJ	C0J	3.5 p	±0.25pF	470	200	0.3±0.03	R
UMK063 CJ3R6CT-F			CJ	C0J	3.6 p	±0.25pF	472	200	0.3±0.03	R
UMK063 CJ3R7CT-F			CJ	C0J	3.7 p	±0.25pF	474	200	0.3±0.03	R
UMK063 CJ3R8CT-F			CJ	C0J	3.8 p	±0.25pF	476	200	0.3±0.03	R
UMK063 CJ3R9CT-F			CJ	C0J	3.9 p	±0.25pF	478	200	0.3±0.03	R
UMK063 CH040CT-F			CH	C0H	4 p	±0.25pF	480	200	0.3±0.03	R
UMK063 CH4R1CT-F			CH	C0H	4.1 p	±0.25pF	482	200	0.3±0.03	R
UMK063 CH4R2CT-F			CH	C0H	4.2 p	±0.25pF	484	200	0.3±0.03	R
UMK063 CH4R3CT-F			CH	C0H	4.3 p	±0.25pF	486	200	0.3±0.03	R
UMK063 CH4R4CT-F			CH	C0H	4.4 p	±0.25pF	488	200	0.3±0.03	R
UMK063 CH4R5CT-F			CH	C0H	4.5 p	±0.25pF	490	200	0.3±0.03	R
UMK063 CH4R6CT-F			CH	C0H	4.6 p	±0.25pF	492	200	0.3±0.03	R
UMK063 CH4R7CT-F			CH	C0H	4.7 p	±0.25pF	494	200	0.3±0.03	R
UMK063 CH4R8CT-F			CH	C0H	4.8 p	±0.25pF	496	200	0.3±0.03	R
UMK063 CH4R9CT-F			CH	C0H	4.9 p	±0.25pF	498	200	0.3±0.03	R
UMK063 CH050CT-F			CH	C0H	5 p	±0.25pF	500	200	0.3±0.03	R
UMK063 CH5R1DT-F			CH	C0H	5.1 p	±0.5pF	502	200	0.3±0.03	R
UMK063 CH5R2DT-F			CH	C0H	5.2 p	±0.5pF	504	200	0.3±0.03	R
UMK063 CH5R3DT-F		CH	C0H	5.3 p	±0.5pF	506	200	0.3±0.03	R	
UMK063 CH5R4DT-F		CH	C0H	5.4 p	±0.5pF	508	200	0.3±0.03	R	
UMK063 CH5R5DT-F		CH	C0H	5.5 p	±0.5pF	510	200	0.3±0.03	R	
UMK063 CH5R6DT-F		CH	C0H	5.6 p	±0.5pF	512	200	0.3±0.03	R	
UMK063 CH5R7DT-F		CH	C0H	5.7 p	±0.5pF	514	200	0.3±0.03	R	
UMK063 CH5R8DT-F		CH	C0H	5.8 p	±0.5pF	516	200	0.3±0.03	R	
UMK063 CH5R9DT-F		CH	C0H	5.9 p	±0.5pF	518	200	0.3±0.03	R	
UMK063 CH060DT-F		CH	C0H	6 p	±0.5pF	520	200	0.3±0.03	R	
UMK063 CH6R1DT-F		CH	C0H	6.1 p	±0.5pF	522	200	0.3±0.03	R	
UMK063 CH6R2DT-F		CH	C0H	6.2 p	±0.5pF	524	200	0.3±0.03	R	
UMK063 CH6R3DT-F		CH	C0H	6.3 p	±0.5pF	526	200	0.3±0.03	R	
UMK063 CH6R4DT-F		CH	C0H	6.4 p	±0.5pF	528	200	0.3±0.03	R	
UMK063 CH6R5DT-F		CH	C0H	6.5 p	±0.5pF	530	200	0.3±0.03	R	
UMK063 CH6R6DT-F		CH	C0H	6.6 p	±0.5pF	532	200	0.3±0.03	R	
UMK063 CH6R7DT-F		CH	C0H	6.7 p	±0.5pF	534	200	0.3±0.03	R	
UMK063 CH6R8DT-F		CH	C0H	6.8 p	±0.5pF	536	200	0.3±0.03	R	
UMK063 CH6R9DT-F		CH	C0H	6.9 p	±0.5pF	538	200	0.3±0.03	R	
UMK063 CH070DT-F		CH	C0H	7 p	±0.5pF	540	200	0.3±0.03	R	
UMK063 CH7R1DT-F		CH	C0H	7.1 p	±0.5pF	542	200	0.3±0.03	R	
UMK063 CH7R2DT-F		CH	C0H	7.2 p	±0.5pF	544	200	0.3±0.03	R	
UMK063 CH7R3DT-F		CH	C0H	7.3 p	±0.5pF	546	200	0.3±0.03	R	
UMK063 CH7R4DT-F		CH	C0H	7.4 p	±0.5pF	548	200	0.3±0.03	R	
UMK063 CH7R5DT-F		CH	C0H	7.5 p	±0.5pF	550	200	0.3±0.03	R	
UMK063 CH7R6DT-F		CH	C0H	7.6 p	±0.5pF	552	200	0.3±0.03	R	
UMK063 CH7R7DT-F		CH	C0H	7.7 p	±0.5pF	554	200	0.3±0.03	R	
UMK063 CH7R8DT-F		CH	C0H	7.8 p	±0.5pF	556	200	0.3±0.03	R	
UMK063 CH7R9DT-F		CH	C0H	7.9 p	±0.5pF	558	200	0.3±0.03	R	
UMK063 CH080DT-F		CH	C0H	8 p	±0.5pF	560	200	0.3±0.03	R	
UMK063 CH8R1DT-F		CH	C0H	8.1 p	±0.5pF	562	200	0.3±0.03	R	
UMK063 CH8R2DT-F		CH	C0H	8.2 p	±0.5pF	564	200	0.3±0.03	R	
UMK063 CH8R3DT-F		CH	C0H	8.3 p	±0.5pF	566	200	0.3±0.03	R	
UMK063 CH8R4DT-F		CH	C0H	8.4 p	±0.5pF	568	200	0.3±0.03	R	
UMK063 CH8R5DT-F		CH	C0H	8.5 p	±0.5pF	570	200	0.3±0.03	R	
UMK063 CH8R6DT-F		CH	C0H	8.6 p	±0.5pF	572	200	0.3±0.03	R	

CERAMIC CAPACITORS

▶ This catalog contains the typical specification only due to the limitation of space. When you consider the purchase of our products, please check our specification. For details of each product (characteristics graph, reliability information, precautions for use, and so on), see our Web site (<http://www.ty-top.com/>).

PARTS NUMBER

Part number 1	Part number 2	Rated voltage [V]	Temperature characteristics	Capacitance [F]	Capacitance tolerance [%]	Q	HALT	Thickness*3 [mm]	Soldering R:Reflow W:Wave
							Rated voltage x %		
UMK063 CH8R7DT-F		50	CH C0H	8.7 p	±0.5pF	574	200	0.3±0.03	R
UMK063 CH8R8DT-F			CH C0H	8.8 p	±0.5pF	576	200	0.3±0.03	R
UMK063 CH8R9DT-F			CH C0H	8.9 p	±0.5pF	578	200	0.3±0.03	R
UMK063 CH090DT-F			CH C0H	9 p	±0.5pF	580	200	0.3±0.03	R
UMK063 CH9R1DT-F			CH C0H	9.1 p	±0.5pF	582	200	0.3±0.03	R
UMK063 CH9R2DT-F			CH C0H	9.2 p	±0.5pF	584	200	0.3±0.03	R
UMK063 CH9R3DT-F			CH C0H	9.3 p	±0.5pF	586	200	0.3±0.03	R
UMK063 CH9R4DT-F			CH C0H	9.4 p	±0.5pF	588	200	0.3±0.03	R
UMK063 CH9R5DT-F			CH C0H	9.5 p	±0.5pF	590	200	0.3±0.03	R
UMK063 CH9R6DT-F			CH C0H	9.6 p	±0.5pF	592	200	0.3±0.03	R
UMK063 CH9R7DT-F			CH C0H	9.7 p	±0.5pF	594	200	0.3±0.03	R
UMK063 CH9R8DT-F			CH C0H	9.8 p	±0.5pF	596	200	0.3±0.03	R
UMK063 CH9R9DT-F			CH C0H	9.9 p	±0.5pF	598	200	0.3±0.03	R
UMK063 CH100DT-F			CH C0H	10 p	±0.5pF	600	200	0.3±0.03	R
UMK063 CH110JT-F			CH C0H	11 p	±5%	620	200	0.3±0.03	R
UMK063 CH120JT-F			CH C0H	12 p	±5%	640	200	0.3±0.03	R
UMK063 CH130JT-F			CH C0H	13 p	±5%	660	200	0.3±0.03	R
UMK063 CH150JT-F			CH C0H	15 p	±5%	700	200	0.3±0.03	R
UMK063 CH160JT-F			CH C0H	16 p	±5%	720	200	0.3±0.03	R
UMK063 CH180JT-F			CH C0H	18 p	±5%	760	200	0.3±0.03	R
UMK063 CH200JT-F			CH C0H	20 p	±5%	800	200	0.3±0.03	R
UMK063 CH220JT-F			CH C0H	22 p	±5%	840	200	0.3±0.03	R
UMK063 CH240JT-F			CH C0H	24 p	±5%	880	200	0.3±0.03	R
UMK063 CH270JT-F			CH C0H	27 p	±5%	940	200	0.3±0.03	R
UMK063 CH300JT-F			CH C0H	30 p	±5%	1000	200	0.3±0.03	R
UMK063 CH330JT-F			CH C0H	33 p	±5%	1000	200	0.3±0.03	R
UMK063 CH360JT-F			CH C0H	36 p	±5%	1000	200	0.3±0.03	R
UMK063 CH390JT-F			CH C0H	39 p	±5%	1000	200	0.3±0.03	R
UMK063 CH430JT-F			CH C0H	43 p	±5%	1000	200	0.3±0.03	R
UMK063 CH470JT-F			CH C0H	47 p	±5%	1000	200	0.3±0.03	R
UMK063 CH510JT-F			CH C0H	51 p	±5%	1000	200	0.3±0.03	R
UMK063 CH560JT-F			CH C0H	56 p	±5%	1000	200	0.3±0.03	R
UMK063 CH620JT-F			CH C0H	62 p	±5%	1000	200	0.3±0.03	R
UMK063 CH680JT-F			CH C0H	68 p	±5%	1000	200	0.3±0.03	R
UMK063 CH750JT-F			CH C0H	75 p	±5%	1000	200	0.3±0.03	R
UMK063 CH820JT-F			CH C0H	82 p	±5%	1000	200	0.3±0.03	R
UMK063 CH910JT-F			CH C0H	91 p	±5%	1000	200	0.3±0.03	R
UMK063 CH101JT-F			CH C0H	100 p	±5%	1000	200	0.3±0.03	R
UMK063 CH111JT-F			CH C0H	110 p	±5%	1000	200	0.3±0.03	R
UMK063 CH121JT-F			CH C0H	120 p	±5%	1000	200	0.3±0.03	R
UMK063 CH131JT-F			CH C0H	130 p	±5%	1000	200	0.3±0.03	R
UMK063 CH151JT-F			CH C0H	150 p	±5%	1000	200	0.3±0.03	R
UMK063 CH181JT-F		CH C0H	180 p	±5%	1000	200	0.3±0.03	R	
UMK063 CH201JT-F		CH C0H	200 p	±5%	1000	200	0.3±0.03	R	
UMK063 CH221JT-F		CH C0H	220 p	±5%	1000	200	0.3±0.03	R	

Temperature Characteristic UΔ : UΔ/U2Δ] 0.3mm thickness (T)

Part number 1	Part number 2	Rated voltage [V]	Temperature characteristics	Capacitance [F]	Capacitance tolerance [%]	Q	HALT	Thickness*3 [mm]	Soldering R:Reflow W:Wave
							Rated voltage x %		
TMK063 UK0R5CT-F		25	UK U2K	0.5 p	±0.25pF	410	200	0.3±0.03	R
TMK063 UK010CT-F			UK U2K	1 p	±0.25pF	420	200	0.3±0.03	R
TMK063 UK1R5CT-F			UK U2K	1.5 p	±0.25pF	430	200	0.3±0.03	R
TMK063 UK020CT-F			UK U2K	2 p	±0.25pF	440	200	0.3±0.03	R
TMK063 UK030CT-F			UK U2K	3 p	±0.25pF	460	200	0.3±0.03	R
TMK063 UJ040CT-F			UJ U2J	4 p	±0.25pF	480	200	0.3±0.03	R
TMK063 UJ050CT-F			UJ U2J	5 p	±0.25pF	500	200	0.3±0.03	R
TMK063 UJ060DT-F			UJ U2J	6 p	±0.5pF	520	200	0.3±0.03	R
TMK063 UJ070DT-F			UJ U2J	7 p	±0.5pF	540	200	0.3±0.03	R
TMK063 UJ080DT-F			UJ U2J	8 p	±0.5pF	560	200	0.3±0.03	R
TMK063 UJ090DT-F			UJ U2J	9 p	±0.5pF	580	200	0.3±0.03	R
TMK063 UJ100DT-F			UJ U2J	10 p	±0.5pF	600	200	0.3±0.03	R
TMK063 UJ120JT-F			UJ U2J	12 p	±5%	640	200	0.3±0.03	R
TMK063 UJ150JT-F			UJ U2J	15 p	±5%	700	200	0.3±0.03	R

105TYPE

Temperature Characteristic CΔ : CΔ/C0Δ] 0.5mm thickness (V)

Part number 1	Part number 2	Rated voltage [V]	Temperature characteristics	Capacitance [F]	Capacitance tolerance [%]	Q	HALT	Thickness*3 [mm]	Soldering R:Reflow W:Wave
							Rated voltage x %		
UMK105 CK0R5CV-F		50	CK C0K	0.5 p	±0.25pF	410	200	0.5±0.05	R
UMK105 CK010CV-F			CK C0K	1 p	±0.25pF	420	200	0.5±0.05	R
UMK105 CK1R5CV-F			CK C0K	1.5 p	±0.25pF	430	200	0.5±0.05	R
UMK105 CK020CV-F			CK C0K	2 p	±0.25pF	440	200	0.5±0.05	R
UMK105 CJ030CV-F			CJ C0J	3 p	±0.25pF	460	200	0.5±0.05	R
UMK105 CH040CV-F			CH C0H	4 p	±0.25pF	480	200	0.5±0.05	R
UMK105 CH050CV-F			CH C0H	5 p	±0.25pF	500	200	0.5±0.05	R
UMK105 CH060DV-F			CH C0H	6 p	±0.5pF	520	200	0.5±0.05	R
UMK105 CH070DV-F			CH C0H	7 p	±0.5pF	540	200	0.5±0.05	R
UMK105 CH080DV-F			CH C0H	8 p	±0.5pF	560	200	0.5±0.05	R
UMK105 CH090DV-F			CH C0H	9 p	±0.5pF	580	200	0.5±0.05	R
UMK105 CH100DV-F			CH C0H	10 p	±0.5pF	600	200	0.5±0.05	R
UMK105 CH120JV-F			CH C0H	12 p	±5%	640	200	0.5±0.05	R
UMK105 CH150JV-F			CH C0H	15 p	±5%	700	200	0.5±0.05	R
UMK105 CH180JV-F			CH C0H	18 p	±5%	760	200	0.5±0.05	R
UMK105 CH220JV-F			CH C0H	22 p	±5%	840	200	0.5±0.05	R
UMK105 CH270JV-F			CH C0H	27 p	±5%	940	200	0.5±0.05	R
UMK105 CH330JV-F			CH C0H	33 p	±5%	1000	200	0.5±0.05	R
UMK105 CH390JV-F			CH C0H	39 p	±5%	1000	200	0.5±0.05	R

▶ This catalog contains the typical specification only due to the limitation of space. When you consider the purchase of our products, please check our specification. For details of each product (characteristics graph, reliability information, precautions for use, and so on), see our Web site (<http://www.ty-top.com/>).

Part number 1	Part number 2	Rated voltage [V]	Temperature characteristics		Capacitance [F]	Capacitance tolerance [%]	Q	HALT	Thickness* ³ [mm]	Soldering R:Reflow W:Wave
								Rated voltage x %		
UMK105 CH470JV-F		50	CH	C0H	47 p	±5%	1000	200	0.5±0.05	R
UMK105 CH560JV-F			CH	C0H	56 p	±5%	1000	200	0.5±0.05	R
UMK105 CH680JV-F			CH	C0H	68 p	±5%	1000	200	0.5±0.05	R
UMK105 CH820JV-F			CH	C0H	82 p	±5%	1000	200	0.5±0.05	R
UMK105 CH101JV-F			CH	C0H	100 p	±5%	1000	200	0.5±0.05	R
UMK105 CH121JV-F			CH	C0H	120 p	±5%	1000	200	0.5±0.05	R
UMK105 CH151JV-F			CH	C0H	150 p	±5%	1000	200	0.5±0.05	R
UMK105 CH181JV-F			CH	C0H	180 p	±5%	1000	200	0.5±0.05	R
UMK105 CH221JV-F			CH	C0H	220 p	±5%	1000	200	0.5±0.05	R
UMK105 CH271JV-F			CH	C0H	270 p	±5%	1000	200	0.5±0.05	R
UMK105 CH331JV-F			CH	C0H	330 p	±5%	1000	200	0.5±0.05	R
UMK105 CH361JV-F			CH	C0H	360 p	±5%	1000	200	0.5±0.05	R
UMK105 CH391JV-F			CH	C0H	390 p	±5%	1000	200	0.5±0.05	R
UMK105 CH431JV-F			CH	C0H	430 p	±5%	1000	200	0.5±0.05	R
UMK105 CH471JV-F			CH	C0H	470 p	±5%	1000	200	0.5±0.05	R
UMK105 CH511JV-F			CH	C0H	510 p	±5%	1000	200	0.5±0.05	R
UMK105 CH561JV-F			CH	C0H	560 p	±5%	1000	200	0.5±0.05	R
UMK105 CH621JV-F			CH	C0H	620 p	±5%	1000	200	0.5±0.05	R
UMK105 CH681JV-F			CH	C0H	680 p	±5%	1000	200	0.5±0.05	R
UMK105 CH751JV-F			CH	C0H	750 p	±5%	1000	200	0.5±0.05	R
UMK105 CH821JV-F			CH	C0H	820 p	±5%	1000	200	0.5±0.05	R
UMK105 CH102JV-F			CH	C0H	1000 p	±5%	1000	200	0.5±0.05	R

[Temperature Characteristic UΔ : UΔ/U2Δ] 0.5mm thickness (V)

Part number 1	Part number 2	Rated voltage [V]	Temperature characteristics		Capacitance [F]	Capacitance tolerance [%]	Q	HALT	Thickness* ³ [mm]	Soldering R:Reflow W:Wave
								Rated voltage x %		
UMK105 UK0R5CV-F		50	UK	U2K	0.5 p	±0.25pF	410	200	0.5±0.05	R
UMK105 UK010CV-F			UK	U2K	1 p	±0.25pF	420	200	0.5±0.05	R
UMK105 UK1R5CV-F			UK	U2K	1.5 p	±0.25pF	430	200	0.5±0.05	R
UMK105 UK020CV-F			UK	U2K	2 p	±0.25pF	440	200	0.5±0.05	R
UMK105 UK030CV-F			UK	U2K	3 p	±0.25pF	460	200	0.5±0.05	R
UMK105 UJ040CV-F			UJ	U2J	4 p	±0.25pF	480	200	0.5±0.05	R
UMK105 UJ050CV-F			UJ	U2J	5 p	±0.25pF	500	200	0.5±0.05	R
UMK105 UJ060DV-F			UJ	U2J	6 p	±0.5pF	520	200	0.5±0.05	R
UMK105 UJ070DV-F			UJ	U2J	7 p	±0.5pF	540	200	0.5±0.05	R
UMK105 UJ080DV-F			UJ	U2J	8 p	±0.5pF	560	200	0.5±0.05	R
UMK105 UJ090DV-F			UJ	U2J	9 p	±0.5pF	580	200	0.5±0.05	R
UMK105 UJ100DV-F			UJ	U2J	10 p	±0.5pF	600	200	0.5±0.05	R
UMK105 UJ120JV-F			UJ	U2J	12 p	±5%	640	200	0.5±0.05	R
UMK105 UJ150JV-F			UJ	U2J	15 p	±5%	700	200	0.5±0.05	R
UMK105 UJ180JV-F			UJ	U2J	18 p	±5%	760	200	0.5±0.05	R
UMK105 UJ220JV-F			UJ	U2J	22 p	±5%	840	200	0.5±0.05	R
UMK105 UJ270JV-F			UJ	U2J	27 p	±5%	940	200	0.5±0.05	R
UMK105 UJ330JV-F			UJ	U2J	33 p	±5%	1000	200	0.5±0.05	R
UMK105 UJ390JV-F			UJ	U2J	39 p	±5%	1000	200	0.5±0.05	R
UMK105 UJ470JV-F			UJ	U2J	47 p	±5%	1000	200	0.5±0.05	R
UMK105 UJ560JV-F			UJ	U2J	56 p	±5%	1000	200	0.5±0.05	R
UMK105 UJ680JV-F			UJ	U2J	68 p	±5%	1000	200	0.5±0.05	R
UMK105 UJ820JV-F			UJ	U2J	82 p	±5%	1000	200	0.5±0.05	R
UMK105 UJ101JV-F			UJ	U2J	100 p	±5%	1000	200	0.5±0.05	R
UMK105 UJ121JV-F			UJ	U2J	120 p	±5%	1000	200	0.5±0.05	R
UMK105 UJ151JV-F			UJ	U2J	150 p	±5%	1000	200	0.5±0.05	R
UMK105 UJ181JV-F			UJ	U2J	180 p	±5%	1000	200	0.5±0.05	R
UMK105 UJ221JV-F			UJ	U2J	220 p	±5%	1000	200	0.5±0.05	R
UMK105 UJ271JV-F			UJ	U2J	270 p	±5%	1000	200	0.5±0.05	R
UMK105 UJ331JV-F			UJ	U2J	330 p	±5%	1000	200	0.5±0.05	R

[Temperature Characteristic SL] 0.5mm thickness (V)

Part number 1	Part number 2	Rated voltage [V]	Temperature characteristics		Capacitance [F]	Capacitance tolerance [%]	Q	HALT	Thickness* ³ [mm]	Soldering R:Reflow W:Wave
								Rated voltage x %		
UMK105 SL121JV-F		50	SL		120 p	±5%	1000	200	0.5±0.05	R
UMK105 SL151JV-F			SL		150 p	±5%	1000	200	0.5±0.05	R
UMK105 SL181JV-F			SL		180 p	±5%	1000	200	0.5±0.05	R
UMK105 SL221JV-F			SL		220 p	±5%	1000	200	0.5±0.05	R
UMK105 SL271JV-F			SL		270 p	±5%	1000	200	0.5±0.05	R
UMK105 SL331JV-F			SL		330 p	±5%	1000	200	0.5±0.05	R

Multilayer Ceramic Capacitors

PACKAGING

① Minimum Quantity

● Taped package

Type(EIA)	Thickness		Standard quantity [pcs]	
	mm	code	Paper tape	Embossed tape
□MK042(01005)	0.2	C, D	—	40000
□MK063(0201)	0.3	P, T	15000	
□WK105(0204) ※	0.3	P	10000	
□MK105(0402)	0.2	C	20000	—
	0.3	P	15000	
	0.5	V	10000	
□VK105(0402) ※	0.5	W	4000	
□MK107(0603)	0.45	K	—	4000
□WK107(0306) ※	0.5	V	—	4000
□MR107(0603)	0.8	A	—	—
□MK212(0805)	0.45	K	4000	—
□WK212(0508) ※	0.85	D	—	3000
□MR212(0805)	1.25	G	—	—
□MK316(1206) □MR316(1206)	0.85	D	4000	—
	1.15	F	—	3000
	1.25	G	—	—
□MK325(1210) □MR325(1210)	1.6	L	—	2000
	0.85	D	—	—
	1.15	F	—	—
	1.9	N	—	—
□MK432(1812)	2.0max.	Y	—	500(T), 1000(P)
	2.5	M	—	500

Note : ※ LW Reverse type.

② Taping material

※No bottom tape for pressed carrier tape

● Card board carrier tape

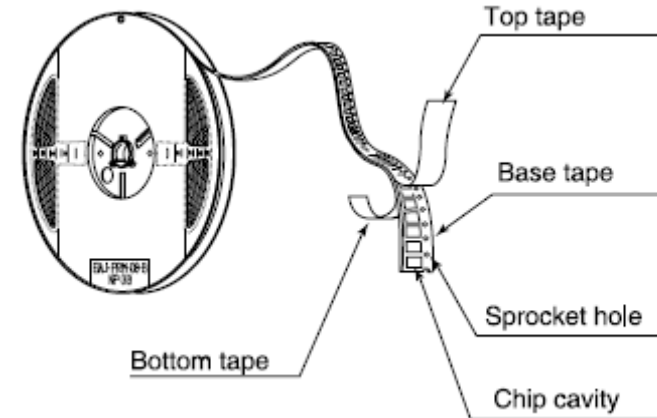

● Embossed tape

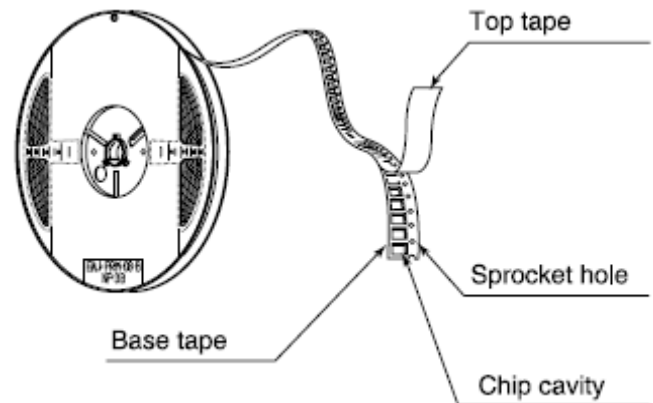

Chip filled

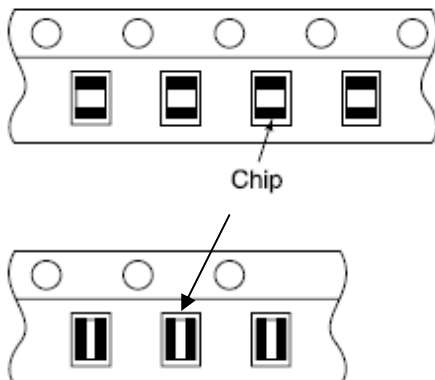

▶ This catalog contains the typical specification only due to the limitation of space. When you consider the purchase of our products, please check our specification. For details of each product (characteristics graph, reliability information, precautions for use, and so on), see our Web site (<http://www.ty-top.com/>).

③ Representative taping dimensions

- Paper Tape (8mm wide)
- Pressed carrier tape (2mm pitch)

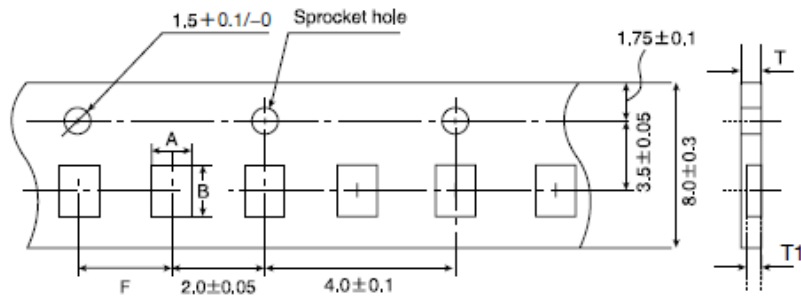

Type(EIA)	Chip Cavity		Insertion Pitch F	Tape Thickness	
	A	B		T	T1
□MK063(0201)	0.37	0.67	2.0±0.05	0.45max.	0.42max.
□WK105(0204) ※	0.65	1.15		0.4max.	0.3max.
□MK105(0402) (*1 C)				0.45max.	0.42max.
□MK105(0402) (*1 P)					

Note *1 Thickness, C: 0.2mm ,P: 0.3mm. ※ LW Reverse type.

Unit: mm

- Punched carrier tape (2mm pitch)

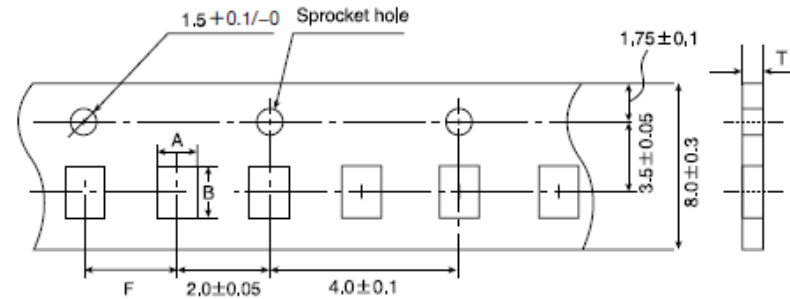

Type(EIA)	Chip Cavity		Insertion Pitch F	Tape Thickness
	A	B		T
□MK105 (0402)	0.65	1.15	2.0±0.05	0.8max.
□VK105 (0402)				

Unit: mm

- Punched carrier tape (4mm pitch)

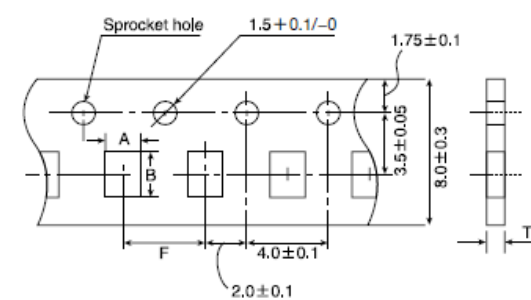

Type(EIA)	Chip Cavity		Insertion Pitch F	Tape Thickness
	A	B		T
□MK107(0603)	1.0	1.8	4.0±0.1	1.1max.
□WK107(0306) ※				1.1max.
□MR107(0603)				
□MK212(0805)	1.65	2.4		1.1max.
□WK212(0508) ※				
□MK316(1206)	2.0	3.6		

Note: Taping size might be different depending on the size of the product. ※ LW Reverse type.

Unit: mm

● Embossed tape (4mm wide)

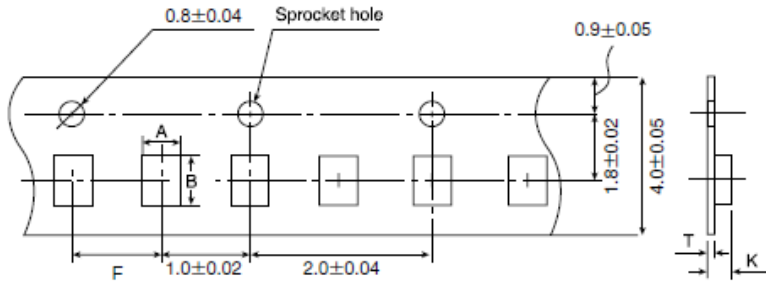

Type(EIA)	Chip Cavity		Insertion Pitch	Tape Thickness	
	A	B		K	T
□MK042(01005)	0.23	0.43	1.0±0.02	0.5max.	0.25max.

Unit: mm

● Embossed tape (8mm wide)

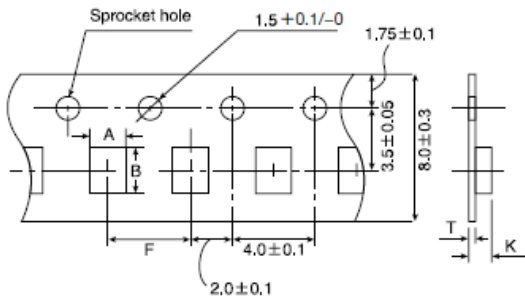

Type(EIA)	Chip Cavity		Insertion Pitch	Tape Thickness	
	A	B		K	T
□WK107(0306) ※	1.0	1.8	4.0±0.1	1.3max.	0.25±0.1
□MK212(0805)	1.65	2.4		3.4max.	0.6max.
□MR212(0805)					
□MK316(1206)	2.0	3.6			
□MR316(1206)					
□MK325(1210)	2.8	3.6			
□MR325(1210)					

Note: ※ LW Reverse type.

Unit: mm

● Embossed tape (12mm wide)

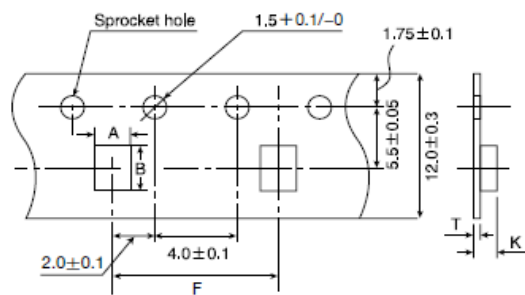

Type(EIA)	Chip Cavity		Insertion Pitch	Tape Thickness	
	A	B		K	T
□MK432(1812)	3.7	4.9	8.0±0.1	4.0max.	0.6max.

Unit: mm

④Trailer and Leader

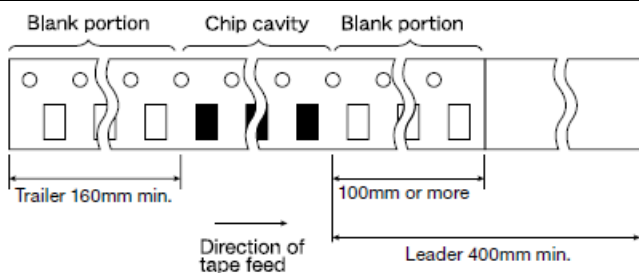

▶ This catalog contains the typical specification only due to the limitation of space. When you consider the purchase of our products, please check our specification. For details of each product (characteristics graph, reliability information, precautions for use, and so on), see our Web site (<http://www.ty-top.com/>).

⑤ Reel size

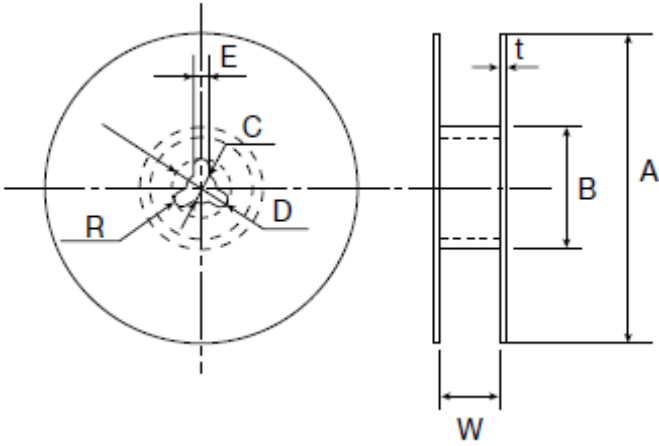

A	B	C	D	E	R
$\phi 178 \pm 2.0$	$\phi 50 \text{min.}$	$\phi 13.0 \pm 0.2$	$\phi 21.0 \pm 0.8$	2.0 ± 0.5	1.0

	T	W
4mm wide tape	1.5max.	5 ± 1.0
8mm wide tape	2.5max.	10 ± 1.5
12mm wide tape	2.5max.	14 ± 1.5

Unit : mm

⑥ Top Tape Strength

The top tape requires a peel-off force of 0.1 to 0.7N in the direction of the arrow as illustrated below.

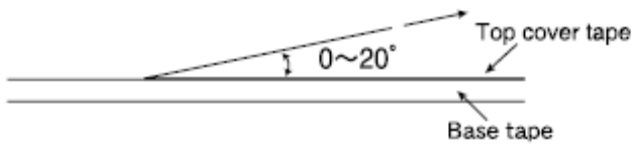

⑦ Bulk Cassette

The exchange of individual specification is necessary.
Please contact Taiyo Yuden sales channels.

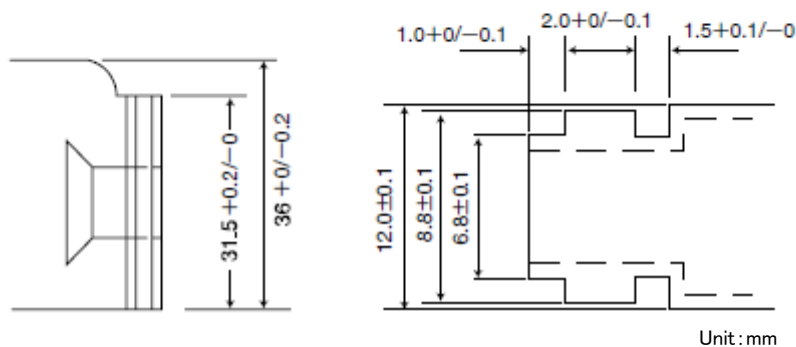
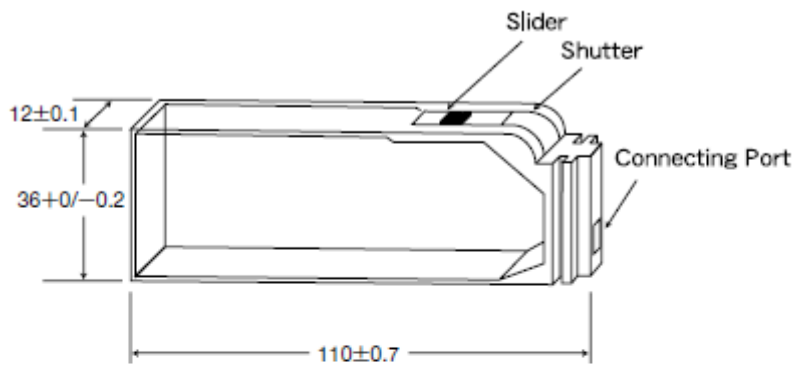

Unit : mm

▶ This catalog contains the typical specification only due to the limitation of space. When you consider the purchase of our products, please check our specification.
For details of each product (characteristics graph, reliability information, precautions for use, and so on), see our Web site (<http://www.ty-top.com/>).

Multilayer Ceramic Capacitors

RELIABILITY DATA

1. Operating Temperature Range

Specified Value	Temperature Compensating (Class1)	Standard	-55 to +125°C	
		High Frequency Type		
Specified Value	High Permittivity (Class2)		Specification	Temperature Range
		BJ	B	-25 to +85°C
			X5R	-55 to +85°C
		B7	X7R	-55 to +125°C
		C6	X6S	-55 to +105°C
		C7	X7S	-55 to +125°C
		LD(※)	X5R	-55 to +85°C
		F	F	-25 to +85°C
Y5V	-30 to +85°C			

Note: ※LD Low distortion high value multilayer ceramic capacitor

2. Storage Conditions

Specified Value	Temperature Compensating (Class1)	Standard	-55 to +125°C	
		High Frequency Type		
Specified Value	High Permittivity (Class2)		Specification	Temperature Range
		BJ	B	-25 to +85°C
			X5R	-55 to +85°C
		B7	X7R	-55 to +125°C
		C6	X6S	-55 to +105°C
		C7	X7S	-55 to +125°C
		LD(※)	X5R	-55 to +85°C
		F	F	-25 to +85°C
Y5V	-30 to +85°C			

Note: ※LD Low distortion high value multilayer ceramic capacitor

3. Rated Voltage

Specified Value	Temperature Compensating (Class1)	Standard	50VDC, 25VDC, 16VDC
		High Frequency Type	50VDC, 16VDC
	High Permittivity (Class2)		50VDC, 35VDC, 25VDC, 16VDC, 10VDC, 6.3VDC, 4VDC, 2.5VDC

4. Withstanding Voltage (Between terminals)

Specified Value	Temperature Compensating (Class1)	Standard	No breakdown or damage
		High Frequency Type	
	High Permittivity (Class2)		
Test Methods and Remarks		Class 1	Class 2
	Applied voltage	Rated volta × 3	Rated voltage × 2.5
	Duration	1 to 5 sec.	
	Charge/discharge current	50mA max.	

5. Insulation Resistance

Specified Value	Temperature Compensating (Class1)	Standard	10000 MΩ min.
		High Frequency Type	
	High Permittivity (Class2) Note 1		C ≤ 0.047 μF : 10000 MΩ min. C > 0.047 μF : 500MΩ · μF
Test Methods and Remarks	Applied voltage	: Rated voltage	
	Duration	: 60 ± 5 sec.	
	Charge/discharge current	: 50mA max.	

▶ This catalog contains the typical specification only due to the limitation of space. When you consider the purchase of our products, please check our specification. For details of each product (characteristics graph, reliability information, precautions for use, and so on), see our Web site (<http://www.ty-top.com/>).

6. Capacitance (Tolerance)					
Specified Value	Temperature Compensating(Class1)	Standard	C□	0.2pF ≤ C ≤ 5pF : ±0.25pF	
			U□	0.2pF ≤ C ≤ 10pF : ±0.5pF	
	SL	C > 10pF : ±5% or ±10%			
High Permittivity (Class2)	High Frequency Type	CH	0.3pF ≤ C ≤ 2pF : ±0.1pF		
		RH	C > 2pF : ±5%		
			BJ, B7, C6, C7, LD(※) : ±10% or ±20%, F : +80/-20% Note: ※LD Low distortion high value multilayer ceramic capacitor		
Test Methods and Remarks			Class 1		
			Standard	High Frequency Type	
	Preconditioning		None		
	Measuring frequency		1MHz ± 10%		
	Measuring voltage Note		0.5 to 5Vrms		
Bias application		one			
		Class 2			
		C ≤ 10 μF		C > 10 μF	
Preconditioning		Thermal treatment (at 150°C for 1hr) Note 2			
Measuring frequency		1kHz ± 10%		120 ± 10Hz	
Measuring voltage Note		1 ± 0.2Vrms		0.5 ± 0.1rms	
Bias application		one			

7. Q or Dissipation Factor					
Specified Value	Temperature Compensating(Class1)	Standard	C < 30pF : Q ≥ 400 + 20C C ≥ 30pF : Q ≥ 1000 (C:Nominal capacitance)		
			High Frequency Type	Refer to detailed specification	
	High Permittivity (Class2) Note 1		BJ, B7, C6, C7: 2.5% max., F: 7% max.		
Test Methods and Remarks			Class 1		
			Standard	High Frequency Type	
	Preconditioning		None		
	Measuring frequency		1MHz ± 10%	1GHz	Thermal treatment (at 150°C for 1hr) Note 2
	Measuring voltage Note 1		0.5 to 5Vrms		1 ± 0.2Vrms
Bias application		None			
High Frequency Type		Measuring equipment : HP4291A			
Measuring equipment		Measuring jig : HP16192A			

8. Temperature Characteristic (Without voltage application)					
Specified Value	Temperature Compensating(Class1)	Standard	Temperature Characteristic [ppm/°C]		Tolerance [ppm/°C]
			C□ : 0	CH, CJ, CK	H : ±60
			U□ : -750	UJ, UK	J : ±120
		SL : +350 to -1000	K : ±250		
High Permittivity (Class2)	High Frequency Type	Temperature Characteristic [ppm/°C]		Tolerance [ppm/°C]	
		C□ : 0	CH	H : ±60	
		R□ : -220	RH		
		Specification	Capacitance change	Reference temperature	Temperature Range
BJ		B	±10%	20°C	-25 to +85°C
		X5R	±15%	25°C	-55 to +85°C
B7		X7R	±15%	25°C	-55 to +125°C
C6		X6S	±22%	25°C	-55 to +105°C
C7		X7S	±22%	25°C	-55 to +125°C
LD(※)		X5R	±15%	25°C	-55 to +85°C
F		F	+30/-80%	20°C	-25 to +85°C
		Y5V	+22/-82%	25°C	-30 to +85°C
Note : ※LD Low distortion high value multilayer ceramic capacitor					
Test Methods and Remarks	Class 1				
	Capacitance at 20°C and 85°C shall be measured in thermal equilibrium, and the temperature characteristic shall be calculated from the following equation.				
	$\frac{(C_{85} - C_{20})}{C_{20} \times \Delta T} \times 10^6 (\text{ppm}/^\circ\text{C}) \quad \Delta T = 65$				
	Class 2				
	Capacitance at each step shall be measured in thermal equilibrium, and the temperature characteristic shall be calculated from the following equation.				
Step	B, F		X5R, X7R, X6S, X7S, Y5V		
1	Minimum operating temperature				
2	20°C		25°C		
3	Maximum operating temperature				

▶ This catalog contains the typical specification only due to the limitation of space. When you consider the purchase of our products, please check our specification. For details of each product (characteristics graph, reliability information, precautions for use, and so on), see our Web site (<http://www.ty-top.com/>).

	$\frac{(C-C_2)}{C_2} \times 100(\%)$ <p>C : Capacitance in Step 1 or Step 3 C2 : Capacitance in Step 2</p>
--	--

9. Deflection

Specified Value	Temperature Compensating (Class1)	Standard	Appearance : No abnormality Capacitance change : Within $\pm 5\%$ or ± 0.5 pF, whichever is larger.
		High Frequency Type	Appearance : No abnormality Capacitance change : Within ± 0.5 pF
	High Permittivity (Class2)		Appearance : No abnormality Capacitance change : Within $\pm 12.5\%$ (BJ, B7, C6, C7, LD(※)) Within $\pm 30\%$ (F) Note: ※LD Low distortion high value multilayer ceramic capacitor

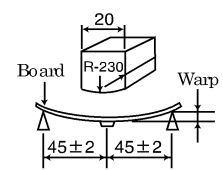
Test Methods and Remarks	<table border="1"> <tr> <th colspan="2">Multilayer Ceramic Capacitors</th> </tr> <tr> <td></td> <td>042, 063, ※105 Type</td> </tr> <tr> <td>Board</td> <td>Glass epoxy-resin substrate</td> </tr> <tr> <td>Thickness</td> <td>0.8mm</td> </tr> <tr> <td>Warp</td> <td>1mm</td> </tr> <tr> <td>Duration</td> <td>10 sec.</td> </tr> </table> <p>※105 Type thickness, C: 0.2mm, P: 0.3mm.</p>		Multilayer Ceramic Capacitors			042, 063, ※105 Type	Board	Glass epoxy-resin substrate	Thickness	0.8mm	Warp	1mm	Duration	10 sec.	 <p>(Unit: mm) Capacitance measurement shall be conducted with the board bent</p>
	Multilayer Ceramic Capacitors														
	042, 063, ※105 Type														
Board	Glass epoxy-resin substrate														
Thickness	0.8mm														
Warp	1mm														
Duration	10 sec.														

10. Body Strength

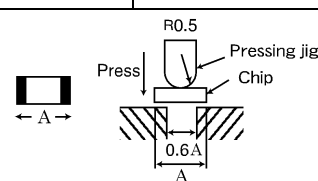
Specified Value	Temperature Compensating (Class1)	Standard	—
		High Frequency Type	No mechanical damage.
	High Permittivity (Class2)		—
Test Methods and Remarks	High Frequency Type Applied force : 5N Duration : 10 sec.		

11. Adhesive Strength of Terminal Electrodes

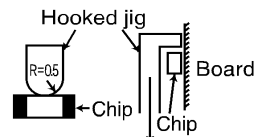
Specified Value	Temperature Compensating (Class1)	Standard	No terminal separation or its indication.								
		High Frequency Type									
	High Permittivity (Class2)										
Test Methods and Remarks	<table border="1"> <tr> <th colspan="2">Multilayer Ceramic Capacitors</th> </tr> <tr> <td></td> <td>042, 063 Type</td> </tr> <tr> <td>Applied force</td> <td>2N</td> </tr> <tr> <td>Duration</td> <td>30 ± 5 sec.</td> </tr> </table>		Multilayer Ceramic Capacitors			042, 063 Type	Applied force	2N	Duration	30 ± 5 sec.	
Multilayer Ceramic Capacitors											
	042, 063 Type										
Applied force	2N										
Duration	30 ± 5 sec.										

12. Solderability

Specified Value	Temperature Compensating (Class1)	Standard	At least 95% of terminal electrode is covered by new solder.												
		High Frequency Type													
	High Permittivity (Class2)														
Test Methods and Remarks	<table border="1"> <tr> <th colspan="2">Eutectic solder</th> <th>Lead-free solder</th> </tr> <tr> <td>Solder type</td> <td>H60A or H63A</td> <td>Sn-3.0Ag-0.5Cu</td> </tr> <tr> <td>Solder temperature</td> <td>230 ± 5°C</td> <td>245 ± 3°C</td> </tr> <tr> <td>Duration</td> <td colspan="2">4 ± 1 sec.</td> </tr> </table>		Eutectic solder		Lead-free solder	Solder type	H60A or H63A	Sn-3.0Ag-0.5Cu	Solder temperature	230 ± 5°C	245 ± 3°C	Duration	4 ± 1 sec.		
Eutectic solder		Lead-free solder													
Solder type	H60A or H63A	Sn-3.0Ag-0.5Cu													
Solder temperature	230 ± 5°C	245 ± 3°C													
Duration	4 ± 1 sec.														

▶ This catalog contains the typical specification only due to the limitation of space. When you consider the purchase of our products, please check our specification. For details of each product (characteristics graph, reliability information, precautions for use, and so on), see our Web site (<http://www.ty-top.com/>).

13. Resistance to Soldering

Specified Value	Temperature Compensating (Class1)	Standard	Appearance : No abnormality Capacitance change : Within $\pm 2.5\%$ or $\pm 0.25\text{pF}$, whichever is larger. Q : Initial value Insulation resistance : Initial value Withstanding voltage (between terminals) : No abnormality
		High Frequency Type	Appearance : No abnormality Capacitance change : Within $\pm 2.5\%$ Q : Initial value Insulation resistance : Initial value Withstanding voltage (between terminals) : No abnormality
	High Permittivity (Class2) Note 1		Appearance : No abnormality Capacitance change : Within $\pm 7.5\%$ (BJ, B7, C6, C7, LD(※)) Within $\pm 20\%$ (F) Dissipation factor : Initial value Insulation resistance : Initial value Withstanding voltage (between terminals) : No abnormality Note: ※LD Low distortion high value multilayer ceramic capacitor

Test Methods and Remarks	Class 1			
		042, 063 Type	105 Type	
	Preconditioning	None		
	Preheating	150°C, 1 to 2 min.	80 to 100°C, 2 to 5 min. 150 to 200°C, 2 to 5 min.	
	Solder temp.	270 \pm 5°C		
	Duration	3 \pm 0.5 sec.		
	Recovery	6 to 24 hrs (Standard condition) Note 5		
	Class 2			
		042, 063 Type	105, 107, 212 Type	316, 325 Type
	Preconditioning	Thermal treatment (at 150°C for 1 hr) Note 2		
	Preheating	150°C, 1 to 2 min.	80 to 100°C, 2 to 5 min. 150 to 200°C, 2 to 5 min.	80 to 100°C, 5 to 10 min. 150 to 200°C, 5 to 10 min.
	Solder temp.	270 \pm 5°C		
	Duration	3 \pm 0.5 sec.		
	Recovery	24 \pm 2 hrs (Standard condition) Note 5		

14. Temperature Cycle (Thermal Shock)

Specified Value	Temperature Compensating (Class1)	Standard	Appearance : No abnormality Capacitance change : Within $\pm 2.5\%$ or $\pm 0.25\text{pF}$, whichever is larger. Q : Initial value Insulation resistance : Initial value Withstanding voltage (between terminals) : No abnormality
		High Frequency Type	Appearance : No abnormality Capacitance change : Within $\pm 0.25\text{pF}$ Q : Initial value Insulation resistance : Initial value Withstanding voltage (between terminals) : No abnormality
	High Permittivity (Class2) Note 1		Appearance : No abnormality Capacitance change : Within $\pm 7.5\%$ (BJ, B7, C6, C7, LD(※)) Within $\pm 20\%$ (F) Dissipation factor : Initial value Insulation resistance : Initial value Withstanding voltage (between terminals) : No abnormality Note: ※LD Low distortion high value multilayer ceramic capacitor

Test Methods and Remarks	Class 1		Class 2		
	Preconditioning	None		Thermal treatment (at 150°C for 1 hr) Note 2	
	1 cycle	Step	Temperature (°C)	Time (min.)	
		1	Minimum operating temperature	30 \pm 3	
		2	Normal temperature	2 to 3	
		3	Maximum operating temperature	30 \pm 3	
4	Normal temperature	2 to 3			
Number of cycles	5 times				
Recovery	6 to 24 hrs (Standard condition) Note 5		24 \pm 2 hrs (Standard condition) Note 5		

▶ This catalog contains the typical specification only due to the limitation of space. When you consider the purchase of our products, please check our specification.
For details of each product (characteristics graph, reliability information, precautions for use, and so on), see our Web site (<http://www.ty-top.com/>).

15. Humidity (Steady State)

Specified Value	Temperature Compensating (Class1)	Standard	Appearance : No abnormality Capacitance change : Within $\pm 5\%$ or $\pm 0.5\text{pF}$, whichever is larger. Q : $C < 10\text{pF} : Q \geq 200 + 10C$ $10 \leq C < 30\text{pF} : Q \geq 275 + 2.5C$ $C \geq 30\text{pF} : Q \geq 350 (C : \text{Nominal capacitance})$ Insulation resistance : $1000 \text{ M}\Omega$ min.
		High Frequency Type	Appearance : No abnormality Capacitance change : Within $\pm 0.5\text{pF}$, Insulation resistance : $1000 \text{ M}\Omega$ min.
	High Permittivity (Class2) Note 1		Appearance : No abnormality Capacitance change : Within $\pm 12.5\%$ (BJ, B7, C6, C7, LD(※)) Within $\pm 30\%$ (F) Dissipation factor : 5.0% max. (BJ, B7, C6, C7, LD(※)) 11.0% max. (F) Insulation resistance : $50 \text{ M}\Omega \mu\text{F}$ or $1000 \text{ M}\Omega$ whichever is smaller. Note: ※LD Low distortion high value multilayer ceramic capacitor

Test Methods and Remarks		Class 1		Class 2
		Standard	High Frequency Type	All items
	Preconditioning	None		
	Temperature	$40 \pm 2^\circ\text{C}$	$60 \pm 2^\circ\text{C}$	$40 \pm 2^\circ\text{C}$
	Humidity	90 to 95%RH		90 to 95%RH
	Duration	$500 + 24 / - 0$ hrs		$500 + 24 / - 0$ hrs
	Recovery	6 to 24 hrs (Standard condition) Note 5		24 ± 2 hrs (Standard condition) Note 5

16. Humidity Loading

Specified Value	Temperature Compensating (Class1)	Standard	Appearance : No abnormality Capacitance change : Within $\pm 7.5\%$ or $\pm 0.75\text{pF}$, whichever is larger. Q : $C < 30\text{pF} : Q \geq 100 + 10C/3$ $C \geq 30\text{pF} : Q \geq 200 (C : \text{Nominal capacitance})$ Insulation resistance : $500 \text{ M}\Omega$ min.
		High Frequency Type	Appearance : No abnormality Capacitance change : $C \leq 2\text{pF} : \text{Within } \pm 0.4 \text{ pF}$ $C > 2\text{pF} : \text{Within } \pm 0.75 \text{ pF}$ (C:Nominal capacitance) Insulation resistance : $500 \text{ M}\Omega$ min.
	High Permittivity (Class2) Note 1		Appearance : No abnormality Capacitance change : Within $\pm 12.5\%$ (BJ, B7, C6, C7, LD(※)) Within $\pm 30\%$ (F) Dissipation factor : 5.0% max. (BJ, B7, C6, C7, LD(※)) 11.0% max. (F) Insulation resistance : $25 \text{ M}\Omega \mu\text{F}$ or $500 \text{ M}\Omega$, whichever is smaller. Note: ※LD Low distortion high value multilayer ceramic capacitor

Test Methods and Remarks		Class 1		Class 2
		Standard	High Frequency Type	All items
	Preconditioning	None		
	Temperature	$40 \pm 2^\circ\text{C}$	$60 \pm 2^\circ\text{C}$	$40 \pm 2^\circ\text{C}$
	Humidity	90 to 95%RH		90 to 95%RH
	Duration	$500 + 24 / - 0$ hrs		$500 + 24 / - 0$ hrs
	Applied voltage	Rated voltage		Rated voltage
	Charge/discharge current	50mA max.		50mA max.
Recovery	6 to 24 hrs (Standard condition) Note 5		24 ± 2 hrs (Standard condition) Note 5	

► This catalog contains the typical specification only due to the limitation of space. When you consider the purchase of our products, please check our specification. For details of each product (characteristics graph, reliability information, precautions for use, and so on), see our Web site (<http://www.ty-top.com/>).

17. High Temperature Loading

Specified Value	Temperature Compensating (Class1)	Standard	Appearance : No abnormality Capacitance change : Within $\pm 3\%$ or $\pm 0.3\text{pF}$, whichever is larger. Q : $C < 10\text{pF}$: $Q \geq 200 + 10C$ $10 \leq C < 30\text{pF}$: $Q \geq 275 + 2.5C$ $C \geq 30\text{pF}$: $Q \geq 350$ (C: Nominal capacitance) Insulation resistance : $1000 \text{ M}\Omega$ min.
		High Frequency Type	Appearance : No abnormality Capacitance change : Within $\pm 3\%$ or $\pm 0.3\text{pF}$, whichever is larger. Insulation resistance : $1000 \text{ M}\Omega$ min.
	High Permittivity (Class2) Note 1		Appearance : No abnormality Capacitance change : Within $\pm 12.5\%$ (BJ, B7, C6, C7, LD(※)) Within $\pm 30\%$ (F) Dissipation factor : 5.0% max. (BJ, B7, C6, C7, LD(※)) 11.0% max. (F) Insulation resistance : $50 \text{ M}\Omega \mu\text{F}$ or $1000 \text{ M}\Omega$, whichever is smaller. Note: ※LD Low distortion high value multilayer ceramic capacitor

Test Methods and Remarks		Class 1		Class 2		
		Standard	High Frequency Type	BJ, LD(※), F	C6	B7, C7
	Preconditioning	None		Voltage treatment (Twice the rated voltage shall be applied for 1 hour at 85°C , 105°C or 125°C) Note 3, 4		
	Temperature	Maximum operating temperature		Maximum operating temperature		
	Duration	$1000 + 48 / - 0$ hrs		$1000 + 48 / - 0$ hrs		
	Applied voltage	Rated voltage $\times 2$		Rated voltage $\times 2$ Note 4		
	Charge/discharge current	50mA max.		50mA max.		
	Recovery	6 to 24hr (Standard condition) Note 5		24 ± 2 hrs (Standard condition) Note 5		

Note: ※LD Low distortion high value multilayer ceramic capacitor

Note 1 The figures indicate typical specifications. Please refer to individual specifications in detail.

Note 2 Thermal treatment : Initial value shall be measured after test sample is heat-treated at $150 \pm 0 / - 10^\circ\text{C}$ for an hour and kept at room temperature for 24 ± 2 hours.

Note 3 Voltage treatment : Initial value shall be measured after test sample is voltage-treated for an hour at both the temperature and voltage specified in the test conditions, and kept at room temperature for 24 ± 2 hours.

Note 4 150% of rated voltage is applicable to some items. Please refer to their specifications for further information.

Note 5 Standard condition: Temperature: 5 to 35°C , Relative humidity: 45 to 85 % RH, Air pressure: 86 to 106kPa When there are questions concerning measurement results, in order to provide correlation data, the test shall be conducted under the following condition.

Temperature: $20 \pm 2^\circ\text{C}$, Relative humidity: 60 to 70 % RH, Air pressure: 86 to 106kPa Unless otherwise specified, all the tests are conducted under the "standard condition".

Precautions on the use of Multilayer Ceramic Capacitors

PRECAUTIONS

1. Circuit Design

- Precautions**
- ◆ Verification of operating environment, electrical rating and performance
 1. A malfunction of equipment in fields such as medical, aerospace, nuclear control, etc. may cause serious harm to human life or have severe social ramifications. Therefore, any capacitors to be used in such equipment may require higher safety and reliability, and shall be clearly differentiated from them used in general purpose applications.
 - ◆ Operating Voltage (Verification of Rated voltage)
 1. The operating voltage for capacitors must always be their rated voltage or less. If an AC voltage is loaded on a DC voltage, the sum of the two peak voltages shall be the rated voltage or less. For a circuit where an AC or a pulse voltage may be used, the sum of their peak voltages shall also be the rated voltage or less.
 2. Even if an applied voltage is the rated voltage or less reliability of capacitors may be deteriorated in case that either a high frequency AC voltage or a pulse voltage having rapid rise time is used in a circuit.

2. PCB Design

- Precautions**
- ◆ Pattern configurations (Design of Land-patterns)
 1. When capacitors are mounted on PCBs, the amount of solder used (size of fillet) can directly affect the capacitor performance. Therefore, the following items must be carefully considered in the design of land patterns:
 - (1) Excessive solder applied can cause mechanical stresses which lead to chip breaking or cracking. Therefore, please consider appropriate land-patterns for proper amount of solder.
 - (2) When more than one component are jointly soldered onto the same land, each component's soldering point shall be separated by solder-resist.
 - ◆ Pattern configurations (Capacitor layout on PCBs)
 After capacitors are mounted on boards, they can be subjected to mechanical stresses in subsequent manufacturing processes (PCB cutting, board inspection, mounting of additional parts, assembly into the chassis, wave soldering of the boards, etc.). For this reason, land pattern configurations and positions of capacitors shall be carefully considered to minimize stresses.

- Technical considerations**
- ◆ Pattern configurations (Design of Land-patterns)
 The following diagrams and tables show some examples of recommended land patterns to prevent excessive solder amounts.
 - (1) Recommended land dimensions for typical chip capacitors
 - Multilayer Ceramic Capacitors : Recommended land dimensions (unit: mm)
 - Wave-soldering

Type		107	212	316	325
Size	L	1.6	2.0	3.2	3.2
	W	0.8	1.25	1.6	2.5
A		0.8 to 1.0	1.0 to 1.4	1.8 to 2.5	1.8 to 2.5
B		0.5 to 0.8	0.8 to 1.5	0.8 to 1.7	0.8 to 1.7
C		0.6 to 0.8	0.9 to 1.2	1.2 to 1.6	1.8 to 2.5

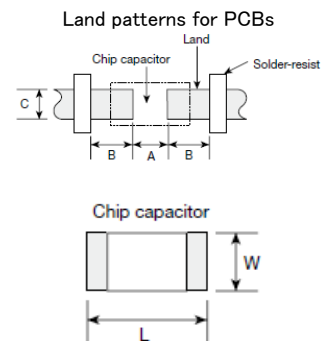

Reflow-soldering

Type	042	063	105	107	212	316	325	432
Size	L	0.4	0.6	1.0	1.6	2.0	3.2	4.5
	W	0.2	0.3	0.5	0.8	1.25	1.6	3.2
A		0.15 to 0.25	0.20 to 0.30	0.45 to 0.55	0.8 to 1.0	0.8 to 1.2	1.8 to 2.5	2.5 to 3.5
B		0.15 to 0.20	0.20 to 0.30	0.40 to 0.50	0.6 to 0.8	0.8 to 1.2	1.0 to 1.5	1.5 to 1.8
C		0.15 to 0.30	0.25 to 0.40	0.45 to 0.55	0.6 to 0.8	0.9 to 1.6	1.2 to 2.0	2.3 to 3.5

Note: Recommended land size might be different according to the allowance of the size of the product.

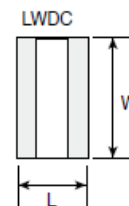

- LWDC: Recommended land dimensions for reflow-soldering (unit: mm)

Type		105	107	212
Size	L	0.52	0.8	1.25
	W	1.0	1.6	2.0
A		0.18 to 0.22	0.25 to 0.3	0.5 to 0.7
B		0.2 to 0.25	0.3 to 0.4	0.4 to 0.5
C		0.9 to 1.1	1.5 to 1.7	1.9 to 2.1

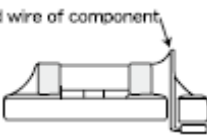
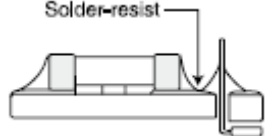
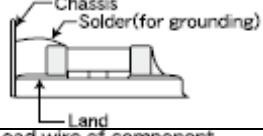
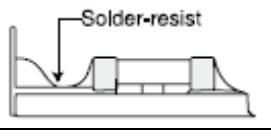
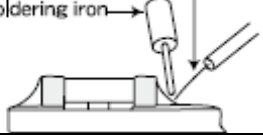

▶ This catalog contains the typical specification only due to the limitation of space. When you consider the purchase of our products, please check our specification. For details of each product (characteristics graph, reliability information, precautions for use, and so on), see our Web site (<http://www.ty-top.com/>).

(2) Examples of good and bad solder application

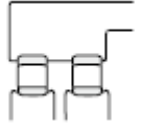
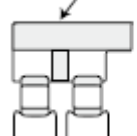
Items	Not eommended	Recommended
Mixed mounting of SMD and leaded components		
Component placement close to the chassis		
Hand-soldering of leaded Components near mounted components		
Horizontal component placement		

◆Pattern configurations (Capacitor layout on PCBs)

1-1. The following is examples of good and bad capacitor layouts ; capacitors shall be located to minimize any possible mechanical stresses from board warp or deflection.

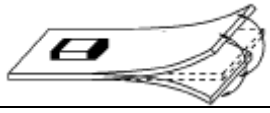
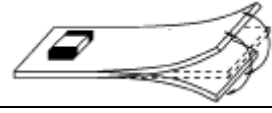
Items	Not recommended	Recommended
Deflection of board		 Place the product at a right angle to the direction of the anticipated mechanical stress.

1-2. The amount of mechanical stresses given will vary depending on capacitor layout. Please refer to diagram below.

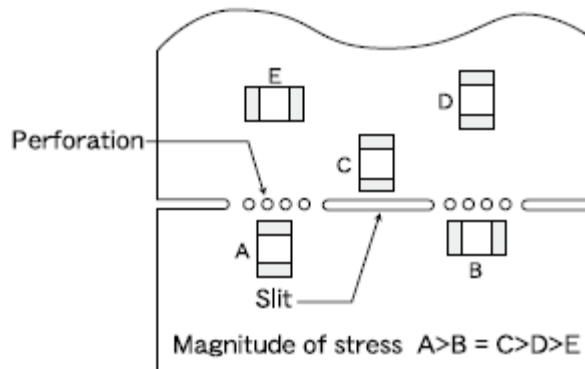

1-3. When PCB is split, the amount of mechanical stress on the capacitors can vary according to the method used. The following methods are listed in order from least stressful to most stressful: push-back, slit, V-grooving, and perforation. Thus, please consider the PCB, split methods as well as chip location.

3. Mounting

Precautions

◆Adjustment of mounting machine

- When capacitors are mounted on PCB, excessive impact load shall not be imposed on them.
- Maintenance and inspection of mounting machines shall be conducted periodically.

◆Selection of Adhesives

- When chips are attached on PCBs with adhesives prior to soldering, it may cause capacitor characteristics degradation unless the following factors are appropriately checked : size of land patterns, type of adhesive, amount applied, hardening temperature and hardening period. Therefore, please contact us for further information.

Technical considerations

◆Adjustment of mounting machine

- When the bottom dead center of a pick-up nozzle is too low, excessive force is imposed on capacitors and causes damages. To avoid this, the following points shall be considerable.
 - The bottom dead center of the pick-up nozzle shall be adjusted to the surface level of PCB without the board deflection.
 - The pressure of nozzle shall be adjusted between 1 and 3 N static loads.
 - To reduce the amount of deflection of the board caused by impact of the pick-up nozzle, supporting pins or back-up pins shall be used on the other side of the PCB. The following diagrams show some typical examples of good and bad pick-up nozzle placement:

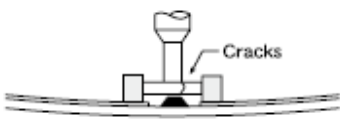
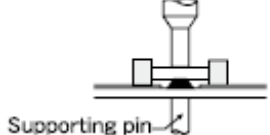
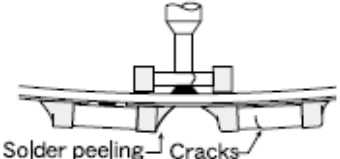
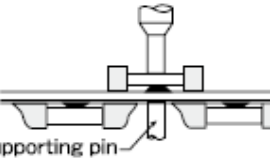
Items	Not recommended	Recommended
Single-sided mounting		
Double-sided mounting		

2. As the alignment pin is worn out, adjustment of the nozzle height can cause chipping or cracking of capacitors because of mechanical impact on the capacitors.
To avoid this, the monitoring of the width between the alignment pins in the stopped position, maintenance, check and replacement of the pin shall be conducted periodically.

◆ Selection of Adhesives

Some adhesives may cause IR deterioration. The different shrinkage percentage of between the adhesive and the capacitors may result in stresses on the capacitors and lead to cracking. Moreover, too little or too much adhesive applied to the board may adversely affect components. Therefore, the following precautions shall be noted in the application of adhesives.

(1) Required adhesive characteristics

- The adhesive shall be strong enough to hold parts on the board during the mounting & solder process.
- The adhesive shall have sufficient strength at high temperatures.
- The adhesive shall have good coating and thickness consistency.
- The adhesive shall be used during its prescribed shelf life.
- The adhesive shall harden rapidly.
- The adhesive shall have corrosion resistance.
- The adhesive shall have excellent insulation characteristics.
- The adhesive shall have no emission of toxic gasses and no effect on the human body.

(2) The recommended amount of adhesives is as follows;

[Recommended condition]

Figure	212/316 case sizes as examples
a	0.3mm min
b	100 to 120 μ m
c	Adhesives shall not contact land

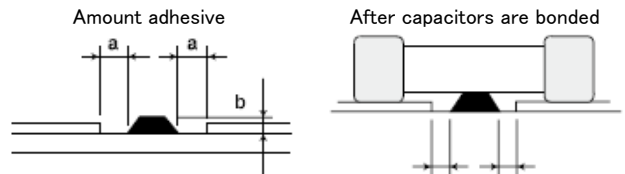

4. Soldering

◆ Selection of Flux

Since flux may have a significant effect on the performance of capacitors, it is necessary to verify the following conditions prior to use;

- Flux used shall be less than or equal to 0.1 wt% (in Cl equivalent) of halogenated content. Flux having a strong acidity content shall not be applied.
- When shall capacitors are soldered on boards, the amount of flux applied shall be controlled at the optimum level.
- When water-soluble flux is used, special care shall be taken to properly clean the boards.

Precautions

◆ Soldering

Temperature, time, amount of solder, etc. shall be set in accordance with their recommended conditions.

Sn-Zn solder paste can adversely affect MLCC reliability.

Please contact us prior to usage of Sn-Zn solder.

◆ Selection of Flux

1-1. When too much halogenated substance (Chlorine, etc.) content is used to activate flux, or highly acidic flux is used, it may lead to corrosion of terminal electrodes or degradation of insulation resistance on the surfaces of the capacitors.

1-2. Flux is used to increase solderability in wave soldering. However if too much flux is applied, a large amount of flux gas may be emitted and may adversely affect the solderability. To minimize the amount of flux applied, it is recommended to use a flux-bubbling system.

1-3. Since the residue of water-soluble flux is easily dissolved in moisture in the air, the residues on the surfaces of capacitors in high humidity conditions may cause a degradation of insulation resistance and reliability of the capacitors. Therefore, the cleaning methods and the capability of the machines used shall also be considered carefully when water-soluble flux is used.

Technical considerations

◆ Soldering

- Ceramic chip capacitors are susceptible to thermal shock when exposed to rapid or concentrated heating or rapid cooling.
- Therefore, the soldering must be conducted with great care so as to prevent malfunction of the components due to excessive thermal shock.
- Preheating : Capacitors shall be preheated sufficiently, and the temperature difference between the capacitors and solder shall be within 100 to 130°C.
- Cooling : The temperature difference between the capacitors and cleaning process shall not be greater than 100°C.

* This catalog contains the typical specification only due to the limitation of space. When you consider the purchase of our products, please check our specification.
For details of each product (characteristics graph, reliability information, precautions for use, and so on), see our Web site (<http://www.ty-top.com/>).

[Reflow soldering]

【Recommended conditions for eutectic soldering】

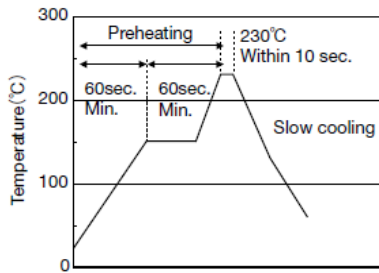

【Recommended condition for Pb-free soldering】

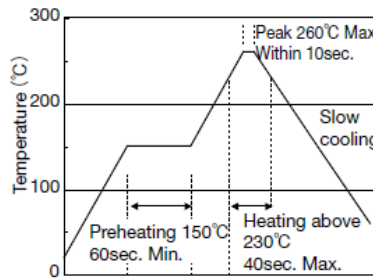

Caution

- ① The ideal condition is to have solder mass (fillet) controlled to $1/2$ to $1/3$ of the thickness of a capacitor.
- ② Because excessive dwell times can adversely affect solderability, soldering duration shall be kept as close to recommended times as possible.

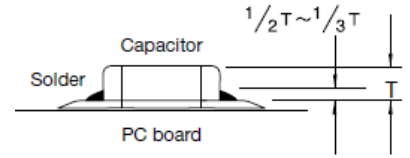

[Wave soldering]

【Recommended conditions for eutectic soldering】

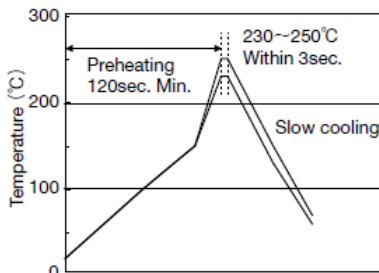

【Recommended condition for Pb-free soldering】

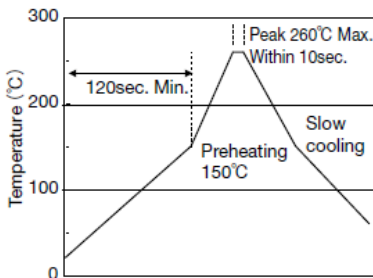

Caution

- ① Wave soldering must not be applied to capacitors designated as for reflow soldering only.

[Hand soldering]

【Recommended conditions for eutectic soldering】

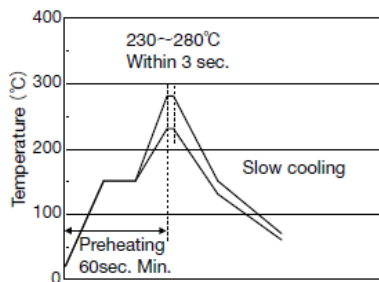

【Recommended condition for Pb-free soldering】

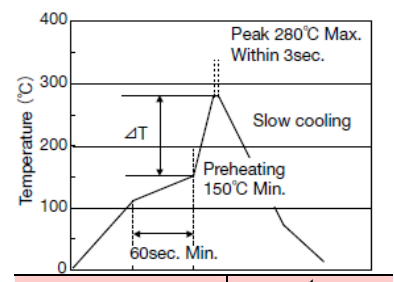
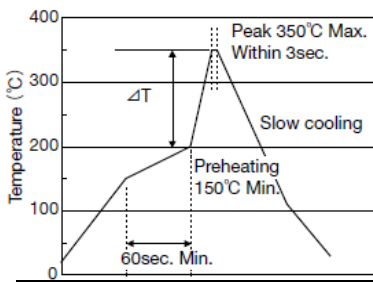

Caution

- ① Use a 50W soldering iron with a maximum tip diameter of 1.0 mm.
- ② The soldering iron shall not directly touch capacitors.

5. Cleaning

◆ Cleaning conditions

1. When PCBs are cleaned after capacitors mounting, please select the appropriate cleaning solution in accordance with the intended use of the cleaning. (e.g. to remove soldering flux or other materials from the production process.)
2. Cleaning condition shall be determined after it is verified by using actual cleaning machine that the cleaning process does not affect capacitor's characteristics.

Technical considerations

1. The use of inappropriate cleaning solutions can cause foreign substances such as flux residue to adhere to capacitors or deteriorate their outer coating, resulting in a degradation of the capacitor's electrical properties (especially insulation resistance).
2. Inappropriate cleaning conditions (insufficient or excessive cleaning) may adversely affect the performance of the capacitors. In the case of ultrasonic cleaning, too much power output can cause excessive vibration of PCBs which may lead to the cracking of capacitors or the soldered portion, or decrease the terminal electrodes' strength. Therefore, the following conditions shall be carefully checked:
 Ultrasonic output : 20 W/l or less
 Ultrasonic frequency : 40 kHz or less
 Ultrasonic washing period : 5 min. or less

▶ This catalog contains the typical specification only due to the limitation of space. When you consider the purchase of our products, please check our specification. For details of each product (characteristics graph, reliability information, precautions for use, and so on), see our Web site (<http://www.ty-top.com/>).

6. Resin coating and mold	
Precautions	<p>1. With some type of resins, decomposition gas or chemical reaction vapor may remain inside the resin during the hardening period or while left under normal storage conditions resulting in the deterioration of the capacitor's performance.</p> <p>2. When a resin's hardening temperature is higher than capacitor's operating temperature, the stresses generated by the excessive heat may lead to damage or destruction of capacitors. The use of such resins, molding materials etc. is not recommended.</p>
7. Handling	
Precautions	<p>◆ Splitting of PCB</p> <p>1. When PCBs are split after components mounting, care shall be taken so as not to give any stresses of deflection or twisting to the board.</p> <p>2. Board separation shall not be done manually, but by using the appropriate devices.</p> <p>◆ Mechanical considerations</p> <p>Be careful not to subject capacitors to excessive mechanical shocks.</p> <p>(1) If ceramic capacitors are dropped onto a floor or a hard surface, they shall not be used.</p> <p>(2) Please be careful that the mounted components do not come in contact with or bump against other boards or components.</p>
8. Storage conditions	
Precautions	<p>◆ Storage</p> <p>1. To maintain the solderability of terminal electrodes and to keep packaging materials in good condition, care must be taken to control temperature and humidity in the storage area. Humidity should especially be kept as low as possible.</p> <p>• Recommended conditions</p> <p style="padding-left: 20px;">Ambient temperature : Below 30°C</p> <p style="padding-left: 20px;">Humidity : Below 70% RH</p> <p style="padding-left: 20px;">The ambient temperature must be kept below 40°C. Even under ideal storage conditions, solderability of capacitor is deteriorated as time passes, so capacitors shall be used within 6 months from the time of delivery.</p> <p>• Ceramic chip capacitors shall be kept where no chlorine or sulfur exists in the air.</p> <p>2. The capacitance values of high dielectric constant capacitors will gradually decrease with the passage of time, so care shall be taken to design circuits. Even if capacitance value decreases as time passes, it will get back to the initial value by a heat treatment at 150°C for 1 hour.</p>
Technical considerations	<p>If capacitors are stored in a high temperature and humidity environment, it might rapidly cause poor solderability due to terminal oxidation and quality loss of taping/packaging materials. For this reason, capacitors shall be used within 6 months from the time of delivery. If exceeding the above period, please check solderability before using the capacitors.</p>
<p>※RCR-2335B (Safety Application Guide for fixed ceramic capacitors for use in electronic equipment) is published by JEITA. Please check the guide regarding precautions for deflection test, soldering by spot heat, and so on.</p>	

单击下面可查看定价，库存，交付和生命周期等信息

[>>Taiyo Yuden\(太阳诱电\)](#)