

## Features

- ◆ Operating voltage: 5.5V
- ◆ Low Input Capacitance: 35pF
- ◆ Complies with following standards:
  - IEC 61000-4-2 (ESD) immunity test  
Air discharge: ±30kV  
Contact discharge: ±30kV
  - IEC61000-4-4 (EFT) 40A (5/50ns)
- ◆ RoHS Compliant

## Mechanical Characteristics

- ◆ Package: SOT-143
- ◆ Lead Finish: Matte Tin
- ◆ Case Material: “Green” Molding Compound.
- ◆ UL Flammability Classification Rating 94V-0
- ◆ Moisture Sensitivity: Level 3 per J-STD-020



## Ordering Information

Part Number	Qty per Reel	Reel Size
TPE05H3S4	3000	7"

## Applications

- ◆ Mobile phone handsets
- ◆ Personal Digital Assistants (PDA)
- ◆ Portable handheld equipment (Laptop, Palmtop computers)
- ◆ Computer port, keyboard (USB1.1)

## Dimensions and Pin Configuration

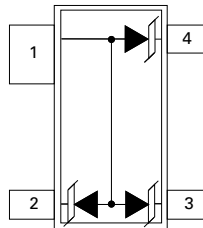

**Absolute Maximum Ratings** (Tamb=25°C unless otherwise specified)

Parameter	Symbol	Value	Unit
ESD per IEC 61000-4-2 (Air)	VESD	±30	kV
ESD per IEC 61000-4-2 (Contact)		±30	
Operating Temperature Range	TJ	-55 to +125	°C
Storage Temperature Range	Tstg	-55 to +150	°C

**Electrical Characteristics** (TA=25°C unless otherwise specified)

Symbol	Parameter
I <sub>PP</sub>	Maximum Reverse Peak Pulse Current
V <sub>C</sub>	Clamping Voltage @ I <sub>PP</sub>
V <sub>RWM</sub>	Working Peak Reverse Voltage
I <sub>R</sub>	Maximum Reverse Leakage Current @ V <sub>RWM</sub>
V <sub>BR</sub>	Breakdown Voltage @ I <sub>T</sub>
I <sub>T</sub>	Test Current
I <sub>F</sub>	Forward Current
V <sub>F</sub>	Forward Voltage @ I <sub>F</sub>
P <sub>pk</sub>	Peak Power Dissipation
C	Capacitance @ V <sub>R</sub> = 0 and f = 1.0 MHz

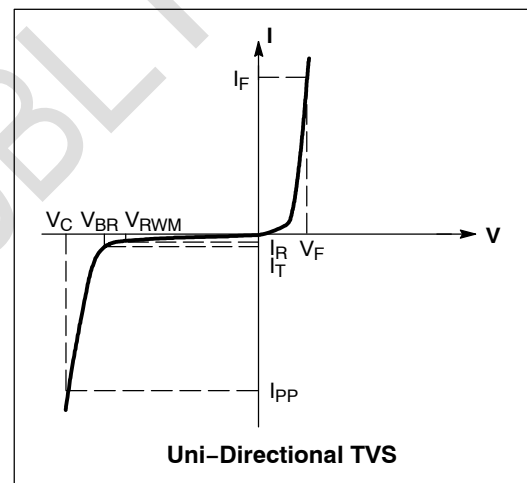

Parameter	Symbol	Min	Typ	Max	Unit	Test Condition
Reverse Working Voltage	V <sub>RWM</sub>			5.5	V	Any I/O pin to ground
Punch-Through Voltage	V <sub>BR</sub>	6			V	I <sub>T</sub> = 1mA, any I/O pin to ground
Reverse Leakage Current	I <sub>R</sub>			1	μA	V <sub>RWM</sub> = 5V, any I/O pin to ground
Clamping Voltage	V <sub>C</sub>			15	V	I <sub>PP</sub> = 1A (8 x 20μs pulse), any I/O pin to ground
Junction Capacitance	C <sub>J</sub>			35	pF	V <sub>R</sub> =0, f=1MHz, between I/O pins

**PROTECTION PRODUCTS**  
Typical characteristics

**Fig1. 8/20μs Pulse Waveform**

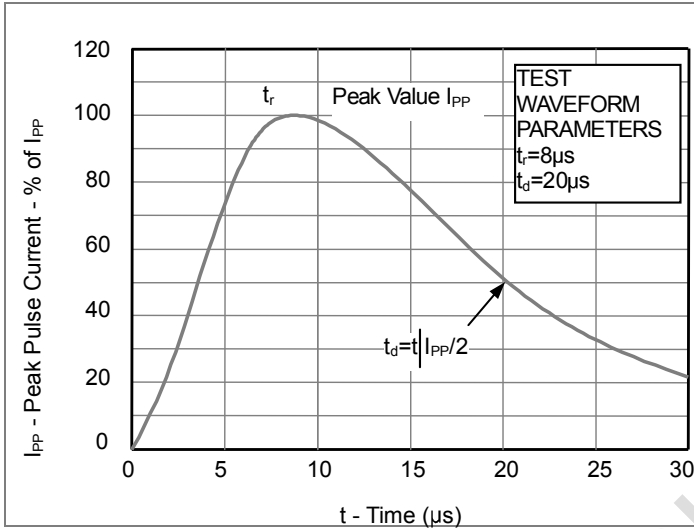

**Fig2. ESD Pulse Waveform (according to IEC 61000-4-2)**

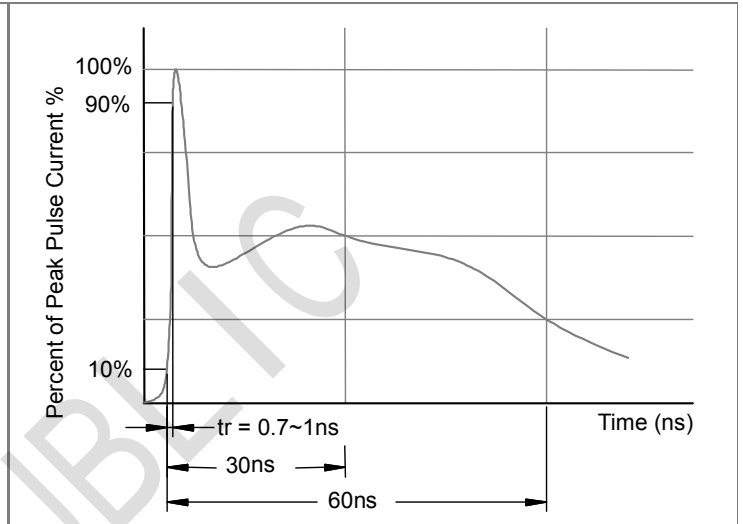

**Fig3. Power Derating Curve**

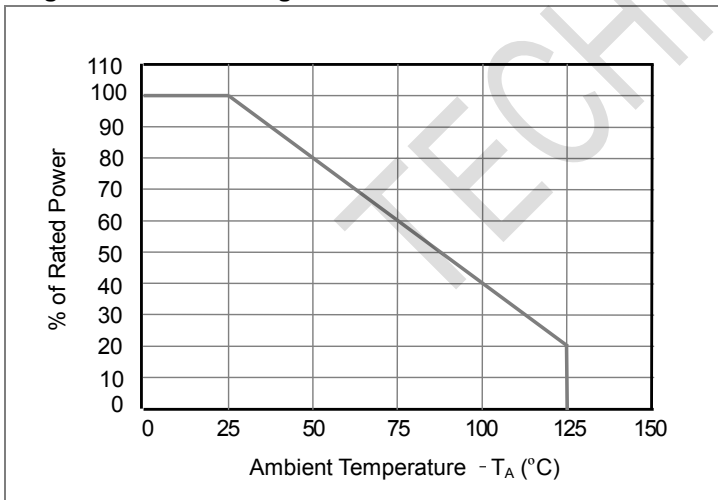

**Outline Drawing - SOT-143**

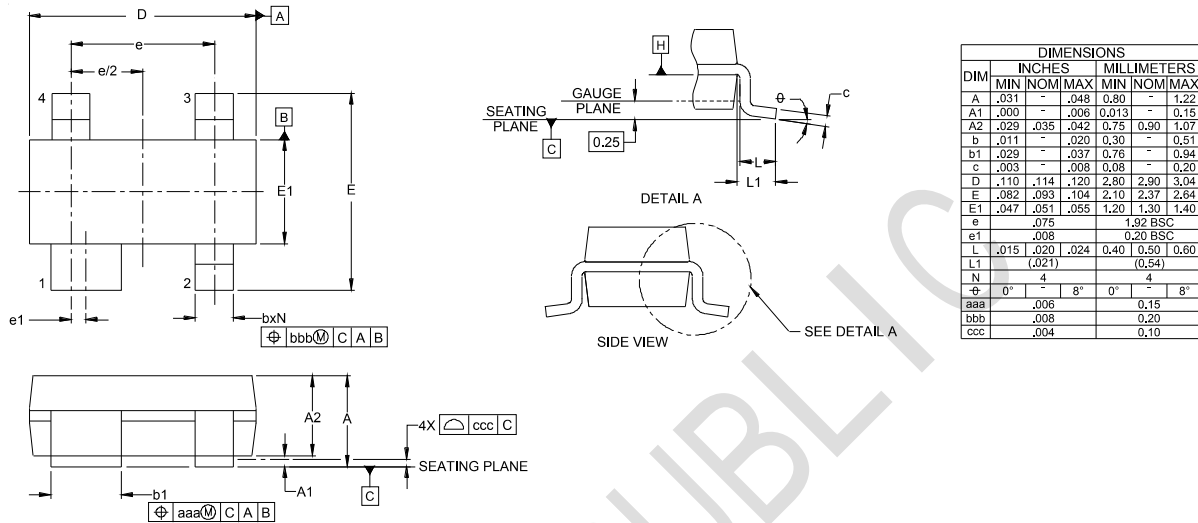

**Land Pattern -SOT-143**

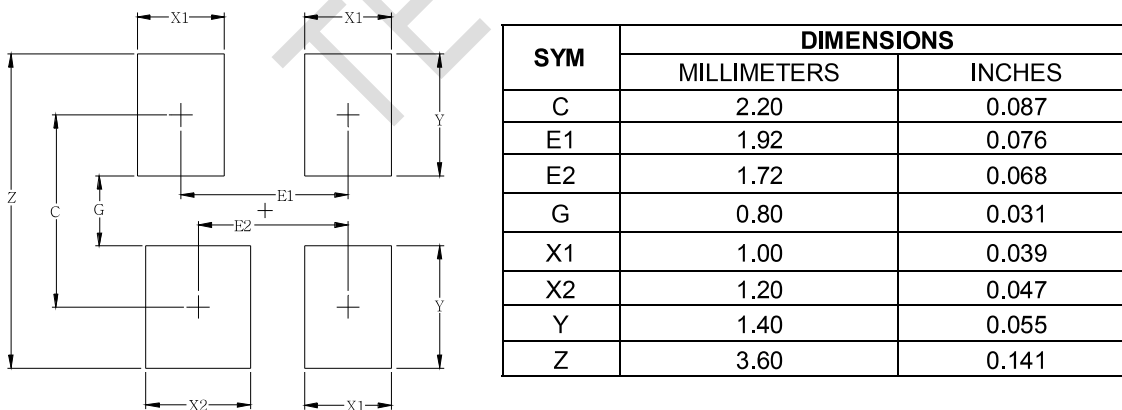

单击下面可查看定价，库存，交付和生命周期等信息

[>>TECH PUBLIC\(台舟\)](#)