

Features

- ◆ Ultra low capacitance: 0.3pF typical (I/O to I/O)
- ◆ Ultra low leakage: nA level
- ◆ Low operating voltage: 3.3V
- ◆ Low clamping voltage
- ◆ Up to 4 data lines and one power line protects
- ◆ Complies with following standards:
 - IEC 61000-4-2 (ESD) immunity test
 - Air discharge: ±20kV
 - Contact discharge: ±15kV
 - IEC61000-4-4 (EFT) 40A (5/50ns)
 - IEC61000-4-5 (Lightning) : 4 A(8/20µs)
- ◆ ROHS Compliant

Ordering Information

Part Number	Qty per Reel	Reel Size
TPESD3324P	3000	7"

Mechanical Characteristics

- ◆ Package: DFN2510-10 (2.5×1.0×0.5mm)
- ◆ Ultra low leakage: nA level
- ◆ Case Material: "Green" Molding Compound.
- ◆ UL Flammability Classification Rating 94V-0
- ◆ Moisture Sensitivity: Level 3 per J-STD-020
- ◆ Terminal Connections: See Diagram Below

Applications

- ◆ High Definition Multimedia Interface (HDMI)
- ◆ Digital Visual Interface (DVI)
- ◆ Unified Display Interface (UDI)
- ◆ MDDI Ports
- ◆ PCI Express
- ◆ Serial ATA

Dimensions and Pin Configuration

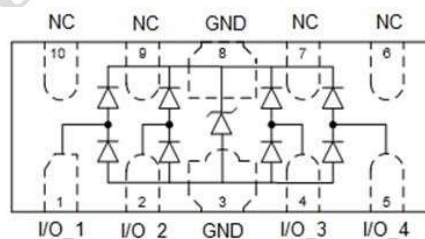

Absolute Maximum Ratings (Tamb=25°C unless otherwise specified)

Parameter	Symbol	Value	Unit
Peak Pulse Power (tp=8/20μs)	PPP	70	W
ESD per IEC 61000-4-2 (Air)	VESD	±20	kV
ESD per IEC 61000-4-2 (Contact)		±15	
Operating Temperature Range	TJ	-55 to +125	°C
Storage Temperature Range	Tstg	-55 to +150	°C

Electrical Characteristics (TA=25°C unless otherwise specified)

Parameter	Symbol	Min	Typ	Max	Unit	Test Condition
Reverse Working Voltage	VRWM			3.3	V	
Breakdown Voltage	VBR	3.6	4	5.5	V	IT = 1mA
Reverse Leakage Current	IR			0.06	μA	VRWM = 3.3V
Clamping Voltage	VC			15	V	I _{PP} = 4A (8 x 20μs pulse) any I/O pin to ground
Junction Capacitance	CJ		0.3	0.4	pF	VR = 0V, f = 1MHz, between I/O pins
Junction Capacitance	CJ			0.8	pF	VR = 0V, f = 1MHz, any I/O pin to ground

Characteristic Curves

Fig1. 8/20 μ s Pulse Waveform

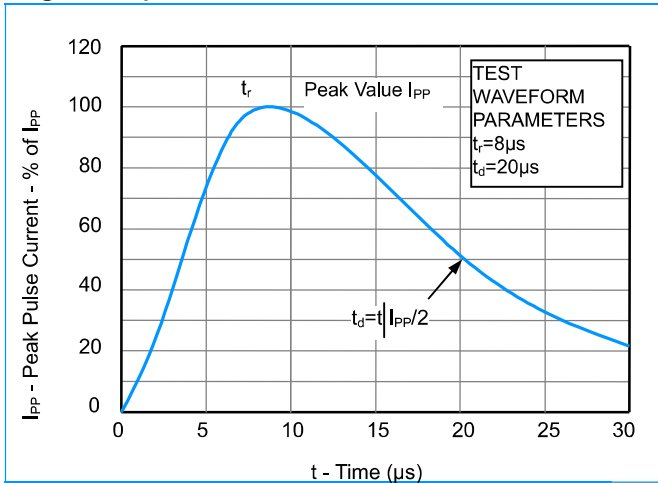

Fig2. ESD Pulse Waveform (according to IEC 61000-4-2)

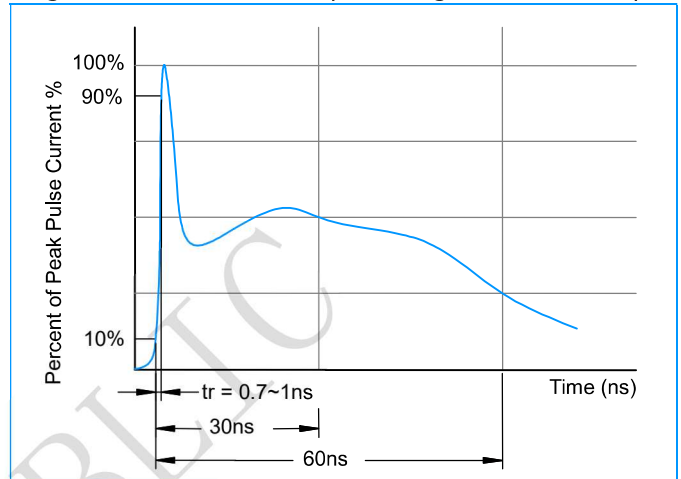
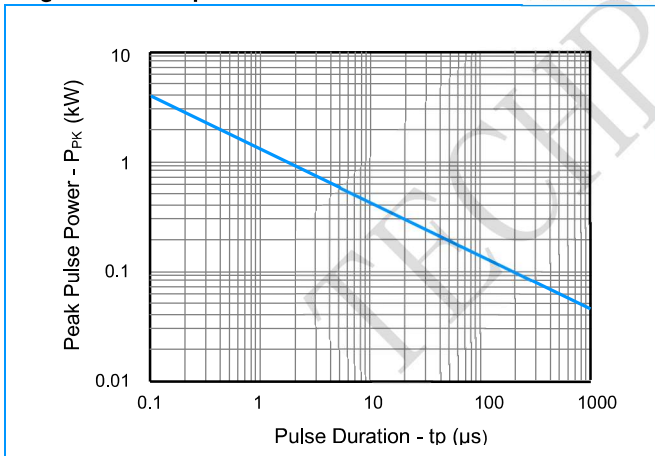
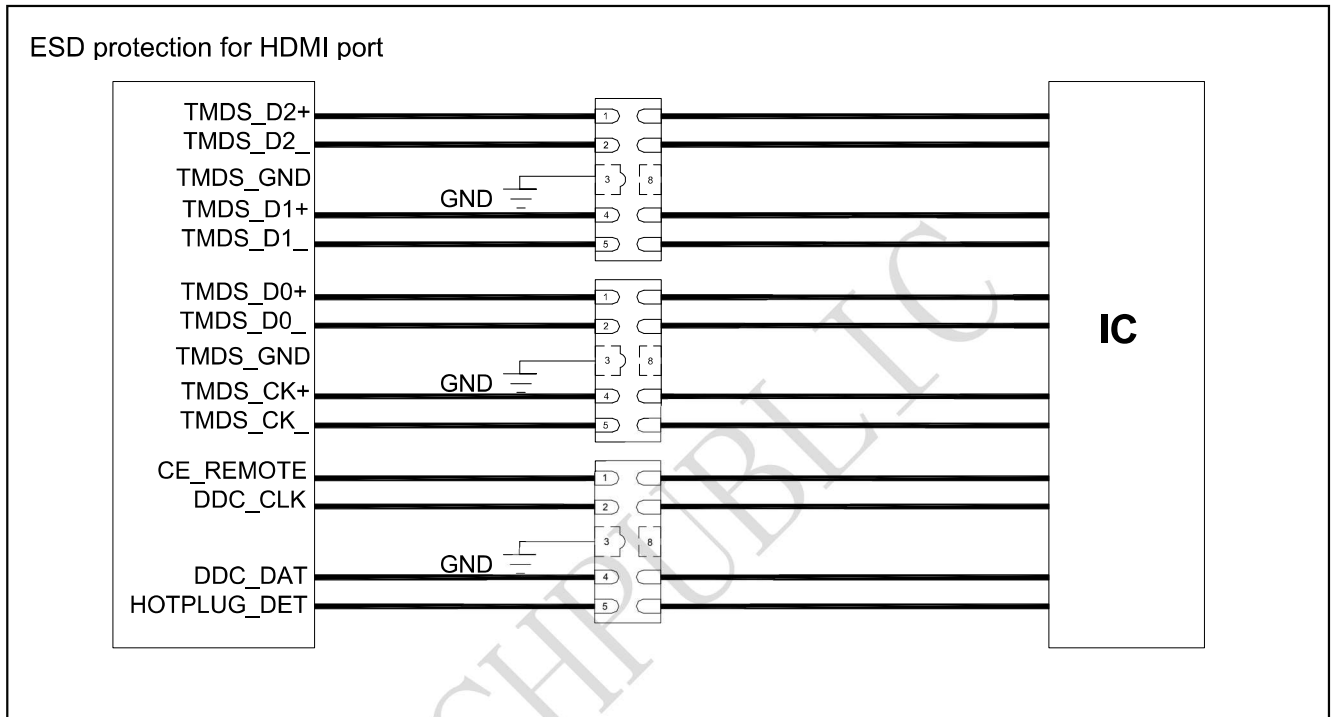

Fig3. Non - Repetitive Peak Pulse Power vs. Pulse Time



Application Information



Outline Drawing - DFN2510-10

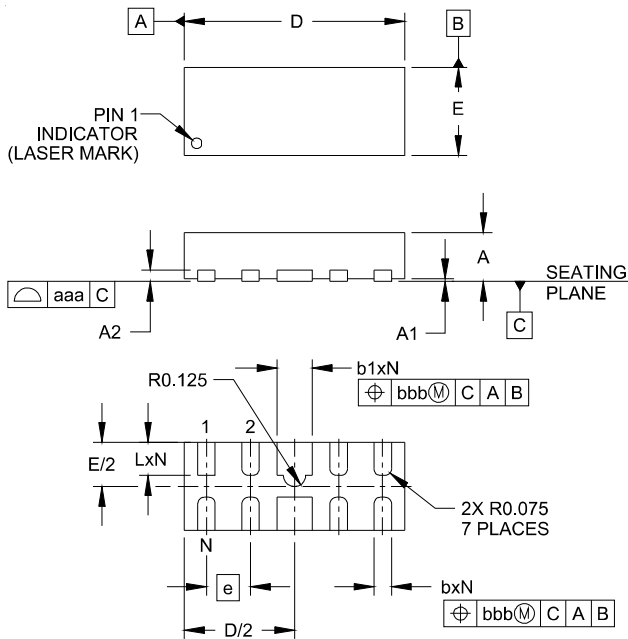

DIM	INCHES			MILLIMETERS		
	MIN	NOM	MAX	MIN	NOM	MAX
A	.020	.023	.026	0.50	0.58	0.65
A1	0.00	.001	.002	0.00	0.03	0.05
A2	(.005)			(0.13)		
b	.006	.008	.010	0.15	0.20	0.25
b1	.014	.016	.018	0.35	0.40	0.45
D	.094	.098	.102	2.40	2.50	2.60
E	.035	.039	.043	0.90	1.00	1.10
e	.020 BSC			0.50 BSC		
L	.012	.015	.017	0.30	0.38	0.425
N	8			8		
aaa	.003			0.08		
bbb	.004			0.10		

Land Pattern - DFN2510-10

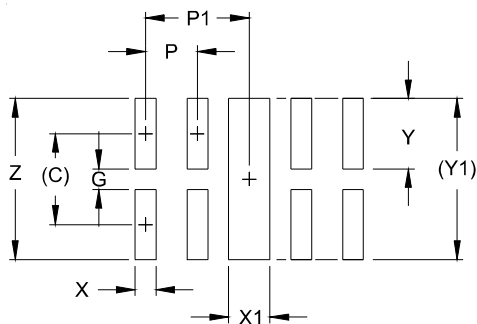

DIM	DIMENSIONS	
	INCHES	MILLIMETERS
C	(.034)	(0.875)
G	.008	0.20
P	.020	0.50
P1	.039	1.00
X	.008	0.20
X1	.016	0.40
Y	.027	0.675
Y1	(.061)	(1.55)
Z	.061	1.55

MARKING CODE:

Or



xxyy= Date code

单击下面可查看定价，库存，交付和生命周期等信息

[>>TECH PUBLIC\(台舟\)](#)