

LOC		DIST		REVISIONS			
P	LTR	DESCRIPTION	DATE	DWN	APVD		
A		RELEASED DRAWING	10AUG2016	TZ	SZ		

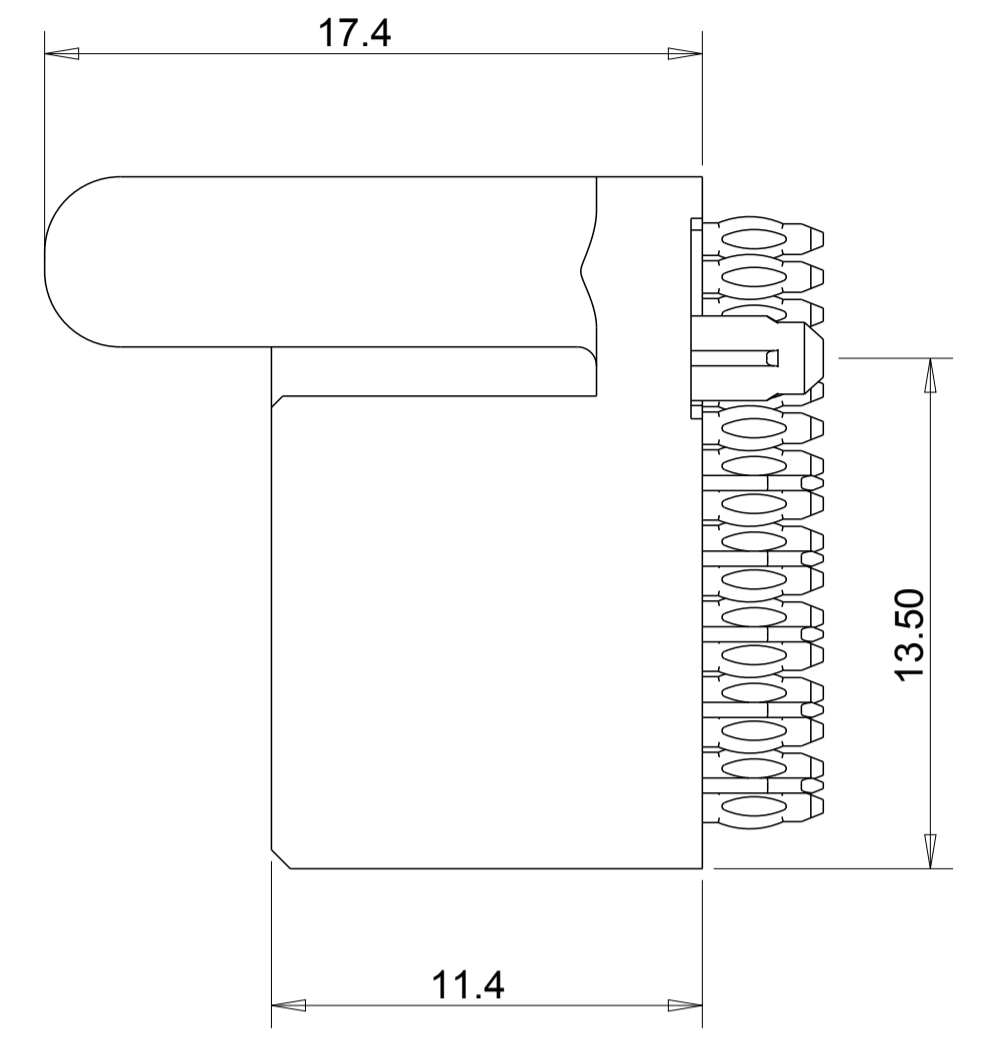

- NOTES, UNLESS OTHERWISE SPECIFIED:
1. "TE" PART NUMBER AND DATE CODE TO BE MARKED IN AREA SHOWN.
 2. MATERIAL:
 - HOUSING - GLASS FILLED HIGH TEMP THERMO PLASTIC, COLOR: BLACK, UL94 V-0.
 - SIGNAL CONTACT - HIGH CONDUCTIVITY COPPER ALLOY.
 - POWER CONTACT - HIGH CONDUCTIVITY COPPER ALLOY.
 3. CONTACT PLATING:
 - MATING AREA - NOBLE METAL OVERALL NICKEL
 - TAIL SIDE AREA - MATTE TIN OVERALL NICKEL.
 4. MECHANICAL CONNECTOR KEEP OUT ZONE.
 5. DATUM AND BASIC DIMENSIONS ESTABLISHED BY CUSTOMER.
 6. PCB - ALL HOLE DIAMETERS ARE FINISHED HOLE SIZES.
 7. PCB HOLE:
 - POWER - 1.15 ± 0.025 MM DRILLED HOLES SIZE PLATING WITH 0.0076 MM MIN. Sn OVER 0.025-0.076 MM Cu PLATING TO ACHIEVE A 1.02 MM DIA. HOLE.
 - SIGNAL - 0.835 ± 0.025 MM DRILLED HOLES SIZE PLATING WITH 0.0076 MM MIN. Sn OVER 0.025-0.076 MM Cu PLATING TO ACHIEVE A 0.72 MM DIA. HOLE.

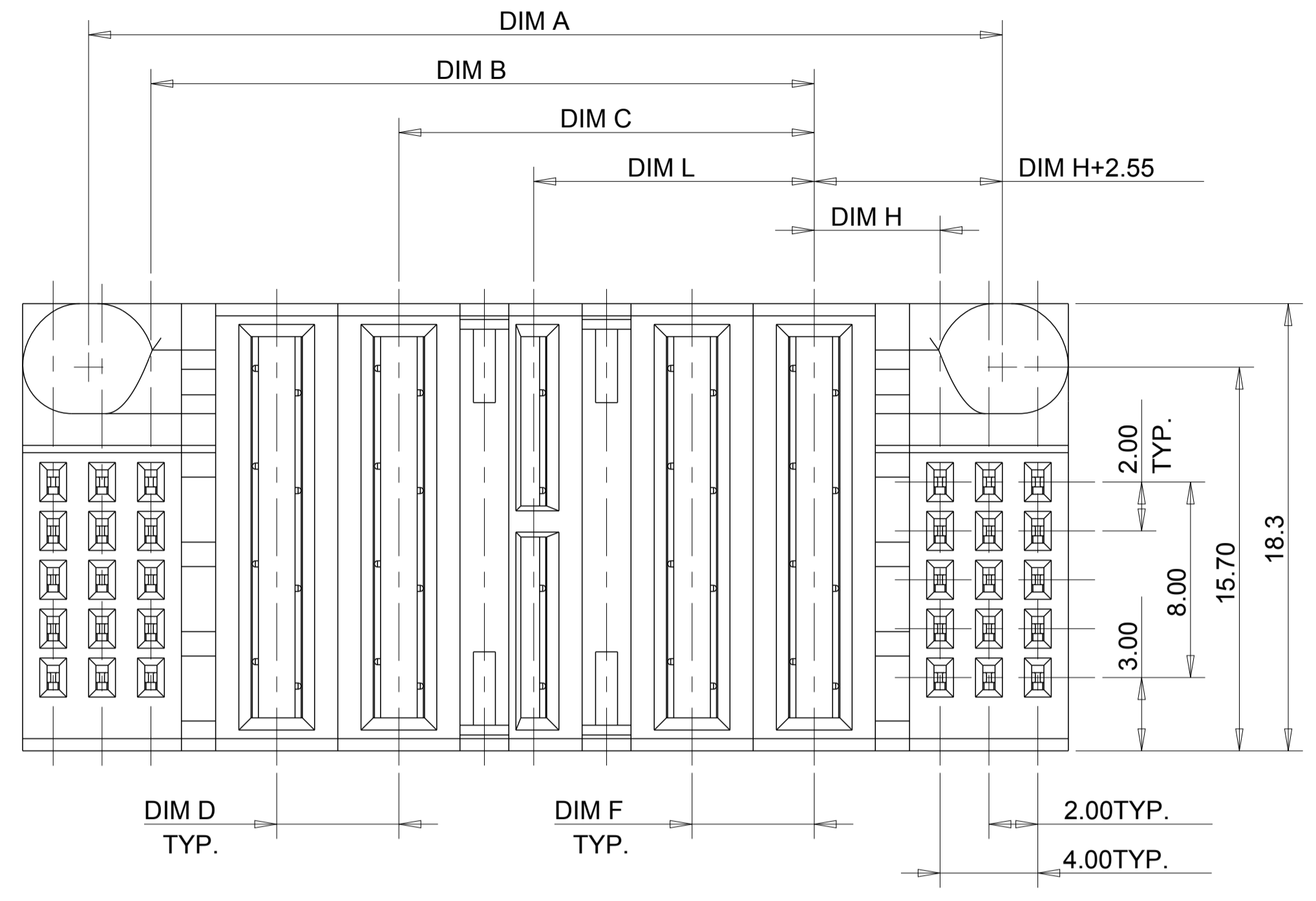
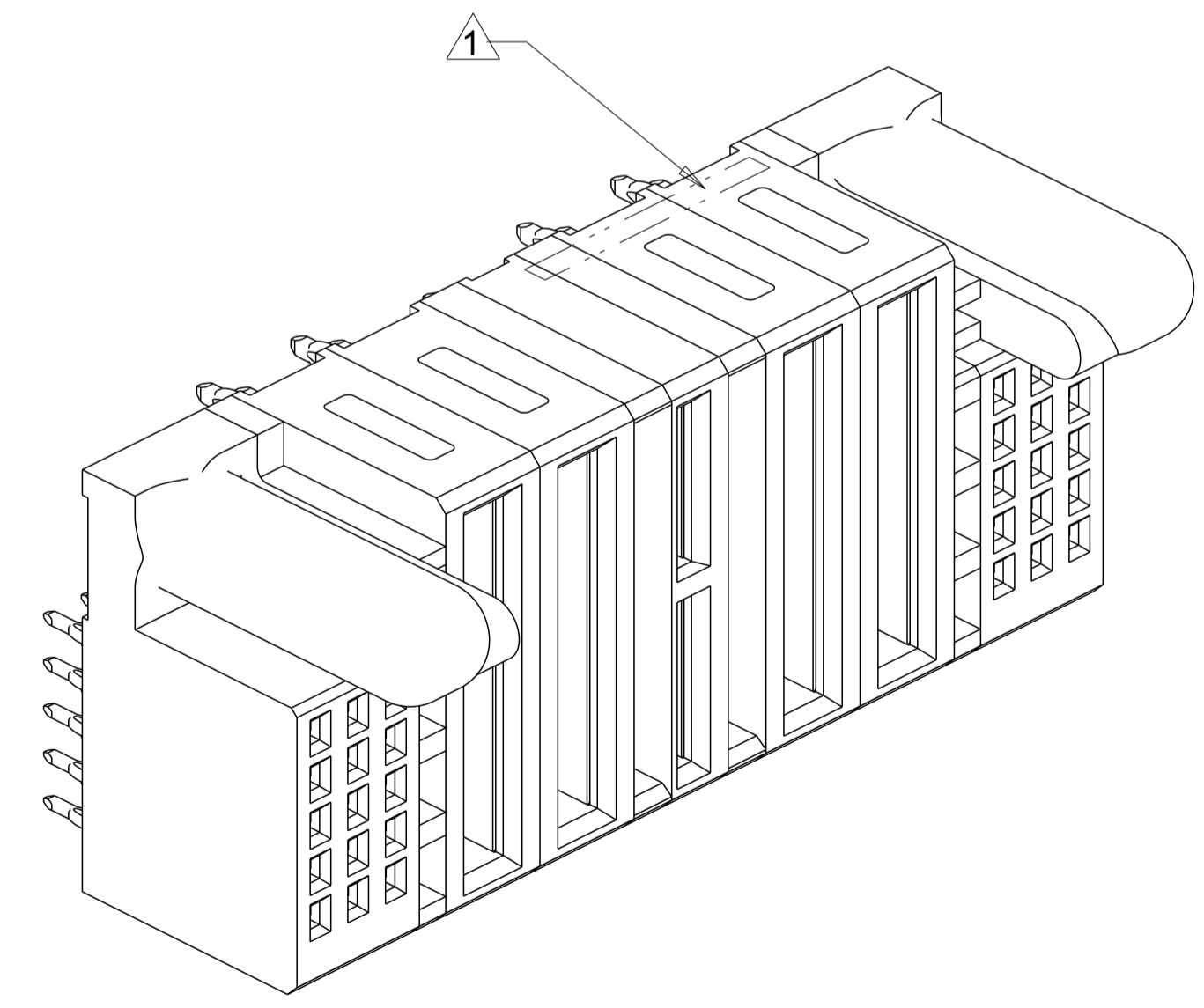
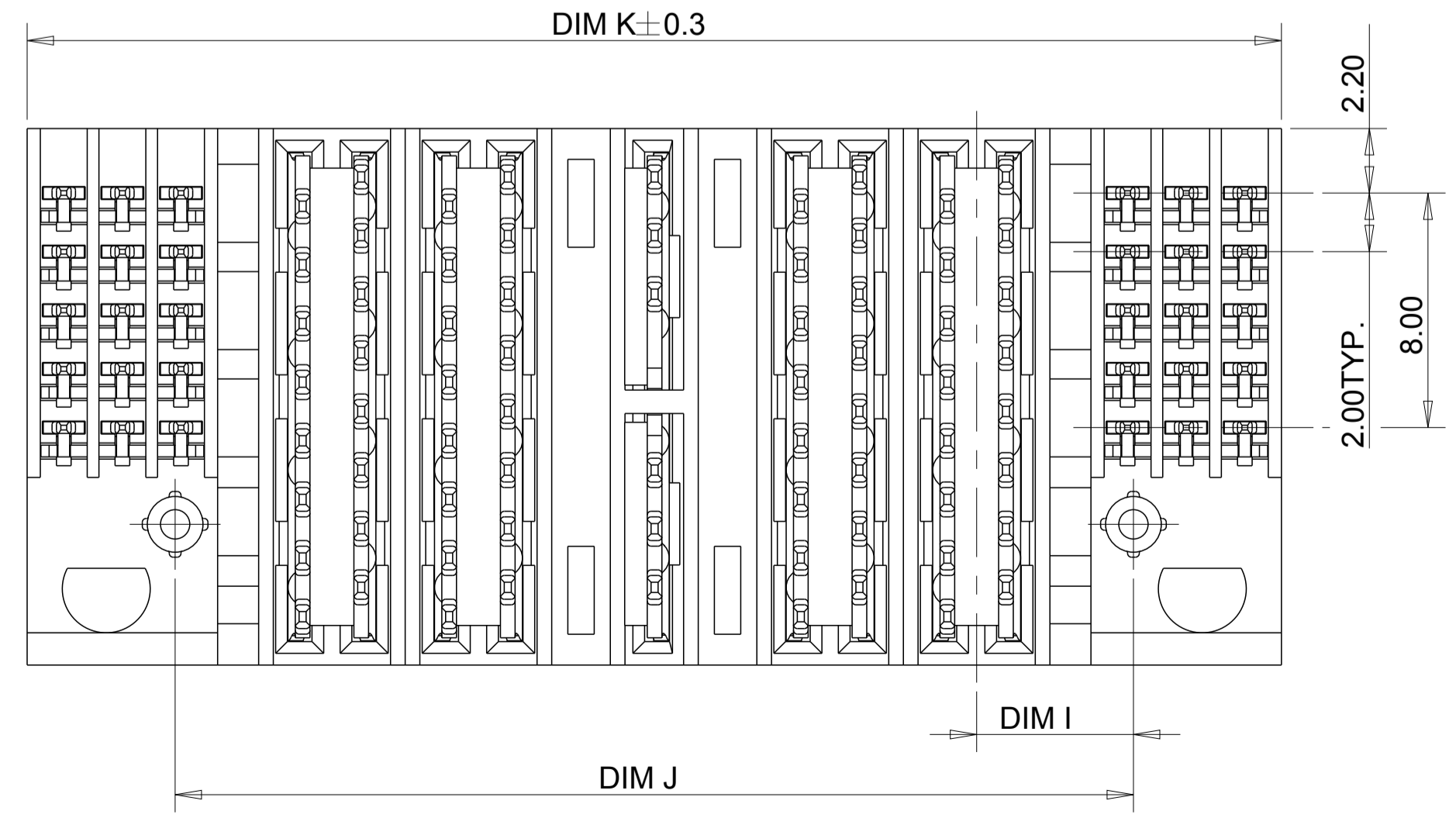
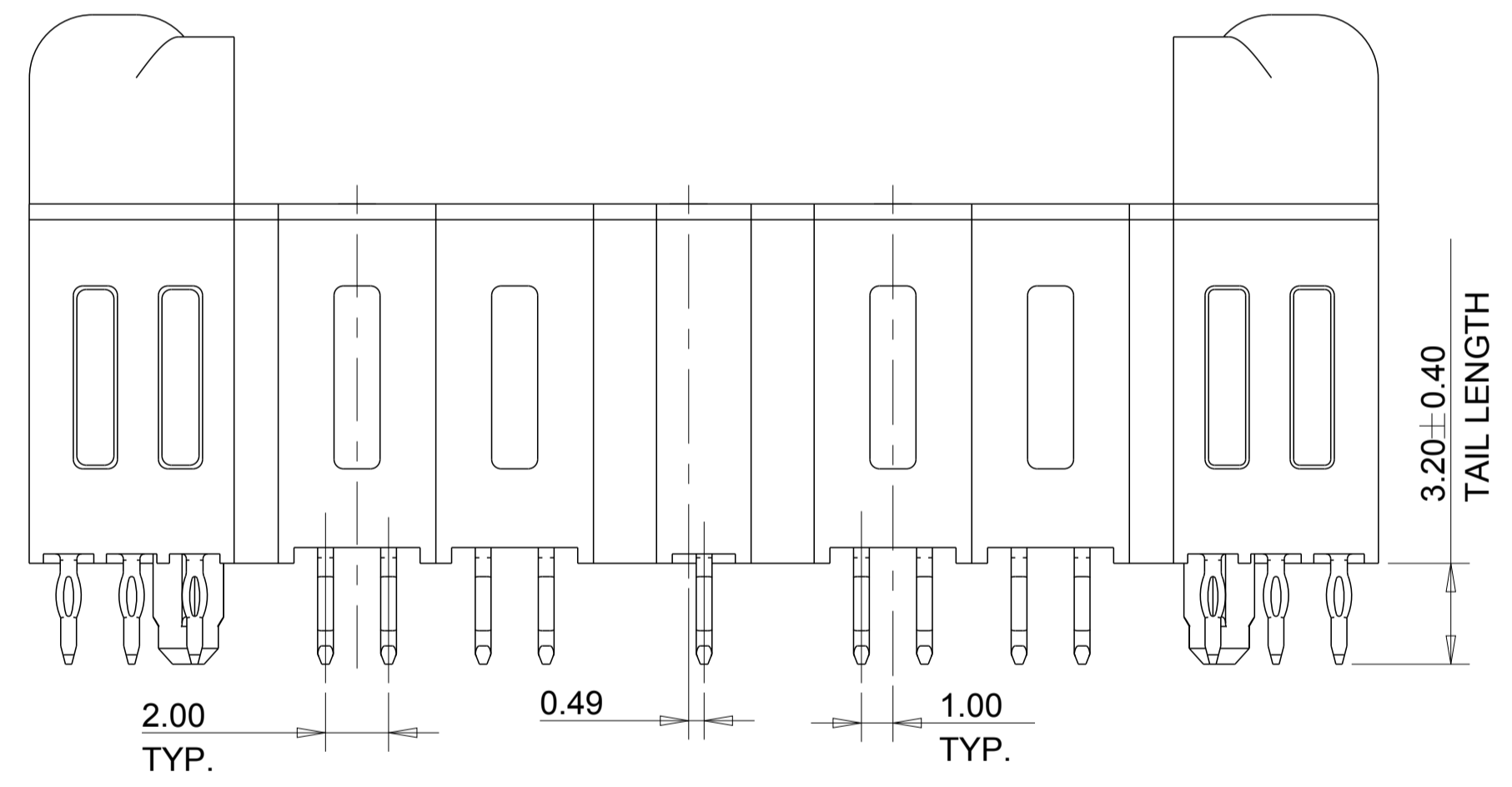

THIS DRAWING IS A CONTROLLED DOCUMENT.		DWN: THOMAS ZHAO 09JAN2013	
DIMENSIONS: mm		CHK: SUNY ZHAO 09JAN2013	
TOLERANCES UNLESS OTHERWISE SPECIFIED:		APVD: SUNY ZHAO 09JAN2013	NAME: Customer Drawing
0 PLC ±		PRODUCT SPEC	VERTICAL RECEPTACLE CONNECTOR
1 PLC ±0.5		APPLICATION SPEC	MULTI-BEAM HD S+P+LP+P+S
2 PLC ±0.25		SIZE: A1	RESTRICTED TO
3 PLC ±0.15		CAGE CODE: -	DRAWING NO: C=2204421
4 PLC ±		WEIGHT: -	SCALE: 5:1
FINISH: ANGLE		CUSTOMER DRAWING	SHEET 1 OF 3
MATERIAL: 2			REV A

LOC		DIST		REVISIONS			
P	LTR	DESCRIPTION	DATE	DWN	APP'D		
-	-	SEE SHEET 1	-	-	-	-	-

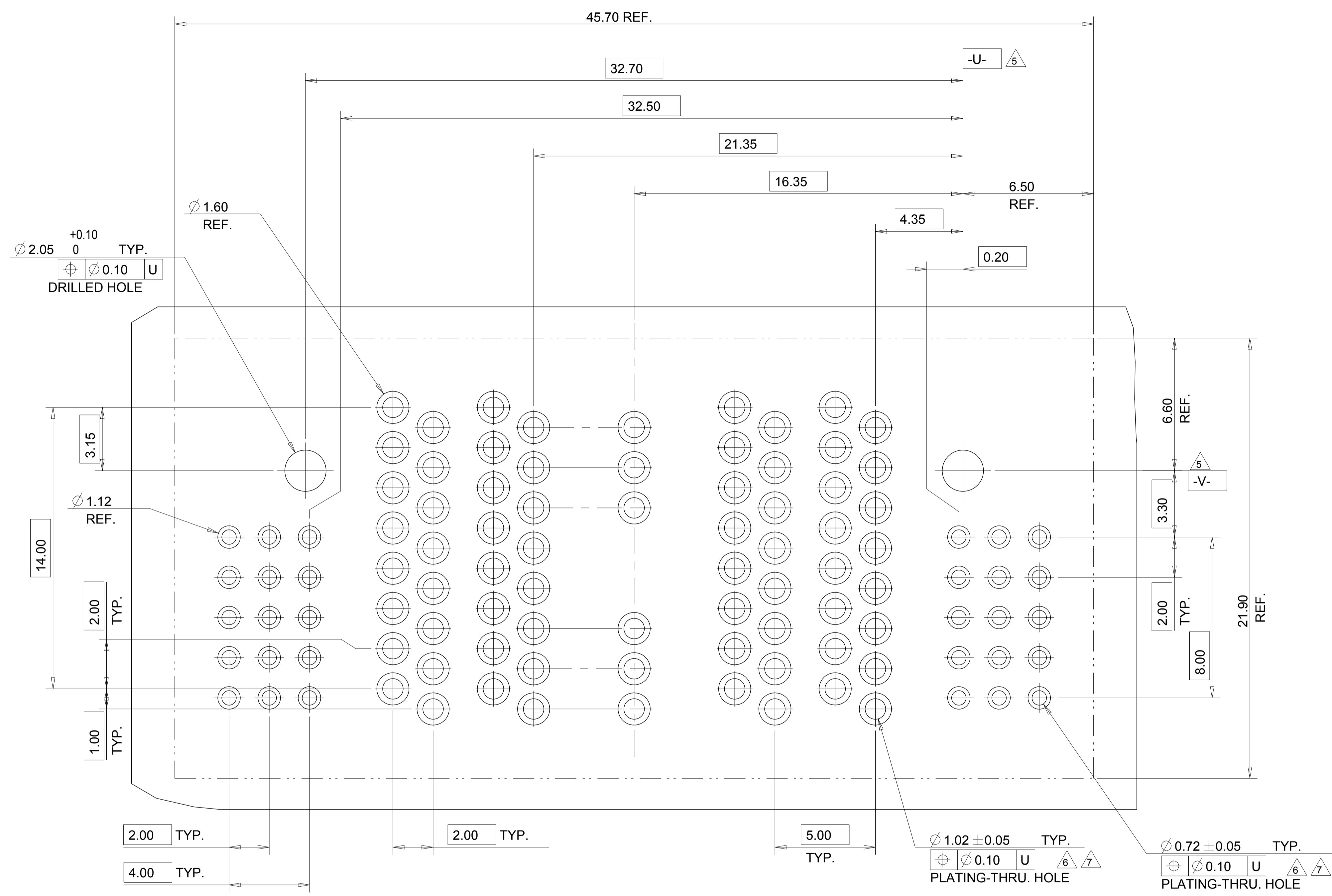

TOP LP CONTACT MFBL PRESS FIT	LM1
BOTTOM LP CONTACT MFBL PRESS FIT	LM2
SIGNAL CONTACT PRESS FIT	SM1
POWER CONTACT MFBL PRESS FIT	PM
DESCRIPTION	IDENTIFIER

PART NUMBER	ROWS	SIGNAL			POWER					SIGNAL		
		6	5	4	P4	P3	LP	P2	PI	3	2	1
2204421-1	E	SM	SM	SM	PM	PM	LM1	PM	PM	SM	SM	SM
	D	SM	SM	SM						SM	SM	SM
	C	SM	SM	SM			LM2			SM	SM	SM
	B	SM	SM	SM						SM	SM	SM
	A	SM	SM	SM						SM	SM	SM

DIM A	DIM B	DIM C	DIM D	DIM F	DIM H	DIM I	DIM J	DIM K	DIM L	DESCRIPTION	PART NUMBER
37.40	27.15	17.00	5.00	5.00	5.15	5.35	32.70	42.80	11.48	15S+2P+2LP+2P+15S	2204421-1

THIS DRAWING IS A CONTROLLED DOCUMENT.		DWN: THOMAS ZHAO 08JAN2013	TE Connectivity Customer Drawing VERTICAL RECEPTACLE CONNECTOR MULTI-BEAM HD S+P+LP+P+S
DIMENSIONS: mm		CHK: SUNY ZHAO 08JAN2013	
TOLERANCES UNLESS OTHERWISE SPECIFIED:		APP'D: SUNY ZHAO 08JAN2013	
0 PLC ± 1 PLC ±0.25 2 PLC ±0.25 3 PLC ±0.15 4 PLC ± FINISH ±		NAME: SUNY ZHAO	
MATERIAL:		WEIGHT:	RESTRICTED TO:
CUSTOMER DRAWING		SCALE: 3:1	SHEET 2 OF 3

LOC		DIST		REVISIONS			
P	LTR	DESCRIPTION	DATE	DWN	APVD		
-	-	SEE SHEET 1	-	-	-		

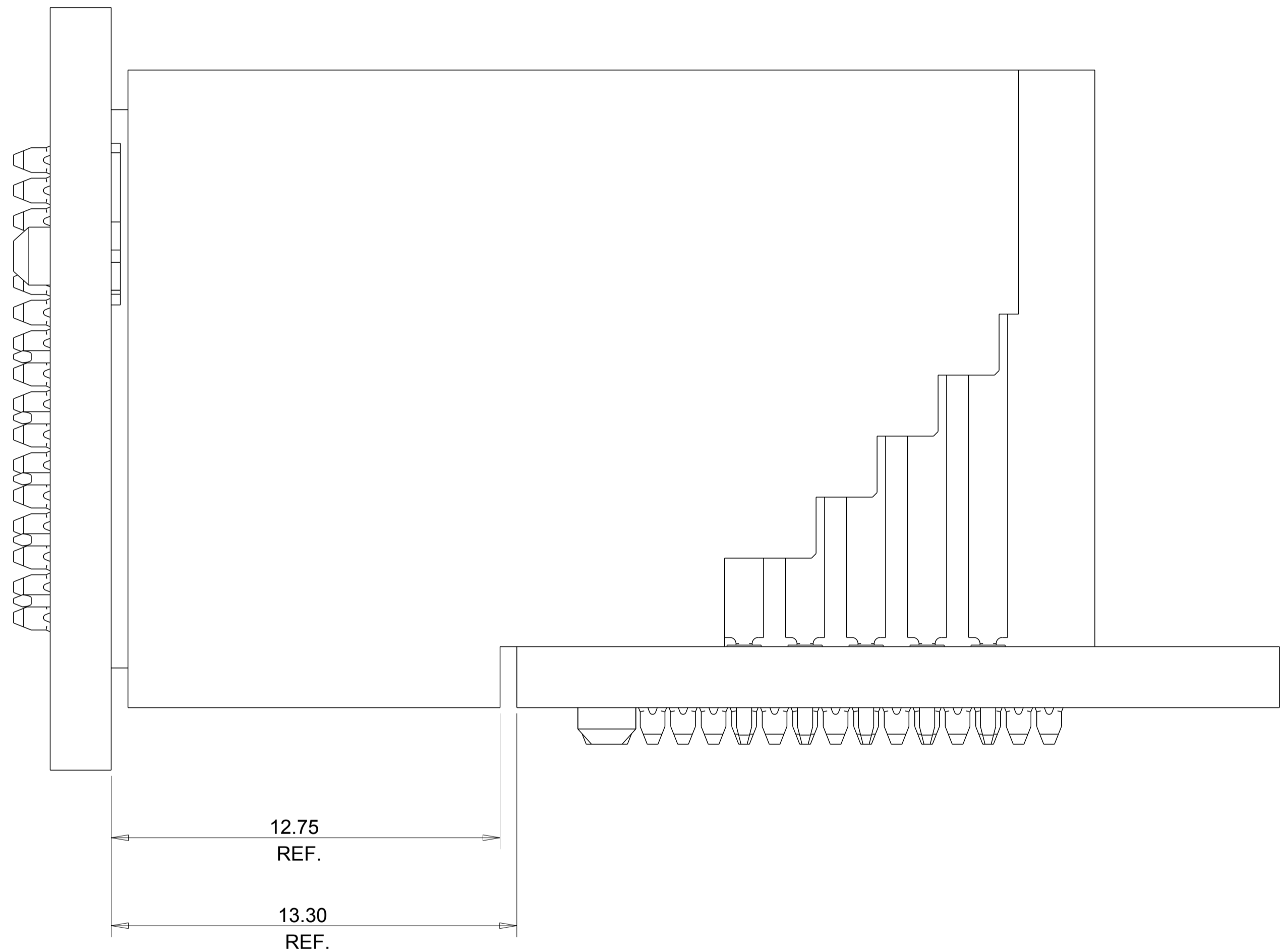

THE DISTANCE IS 0.05 MM MATING FACE FROM R/A HEADER TO VERTICAL RECEPTACLE.

THIS DRAWING IS A CONTROLLED DOCUMENT.		DWN	THOMAS ZHAO	08JAN2013	
		CHK	SUNY ZHAO	08JAN2013	
		APVD	SUNY ZHAO	08JAN2013	NAME
		PRODUCT SPEC			Customer Drawing
		APPLICATION SPEC			VERTICAL RECEPTACLE CONNECTOR
		WEIGHT			MULTI-BEAM HD S+P+LP+P+S
		SIZE	A1	CAGE CODE	RESTRICTED TO
		DRAWING NO			
		SCALE			3:1
		SHEET			3 OF 3
		REV			A
		CUSTOMER DRAWING			

单击下面可查看定价，库存，交付和生命周期等信息

[>>TE Connectivity\(泰科\)](#)