

THIS DRAWING IS UNPUBLISHED. RELEASED FOR PUBLICATION
 © COPYRIGHT - Tyco Electronics JAPAN G.K. ALL RIGHTS RESERVED.

LOC	DIST	REVISIONS					
		P	LTR	DESCRIPTION	DATE	DWN	APVD
ES	-	C		ECR-17-006884	12MAY2017	B.L	C.W

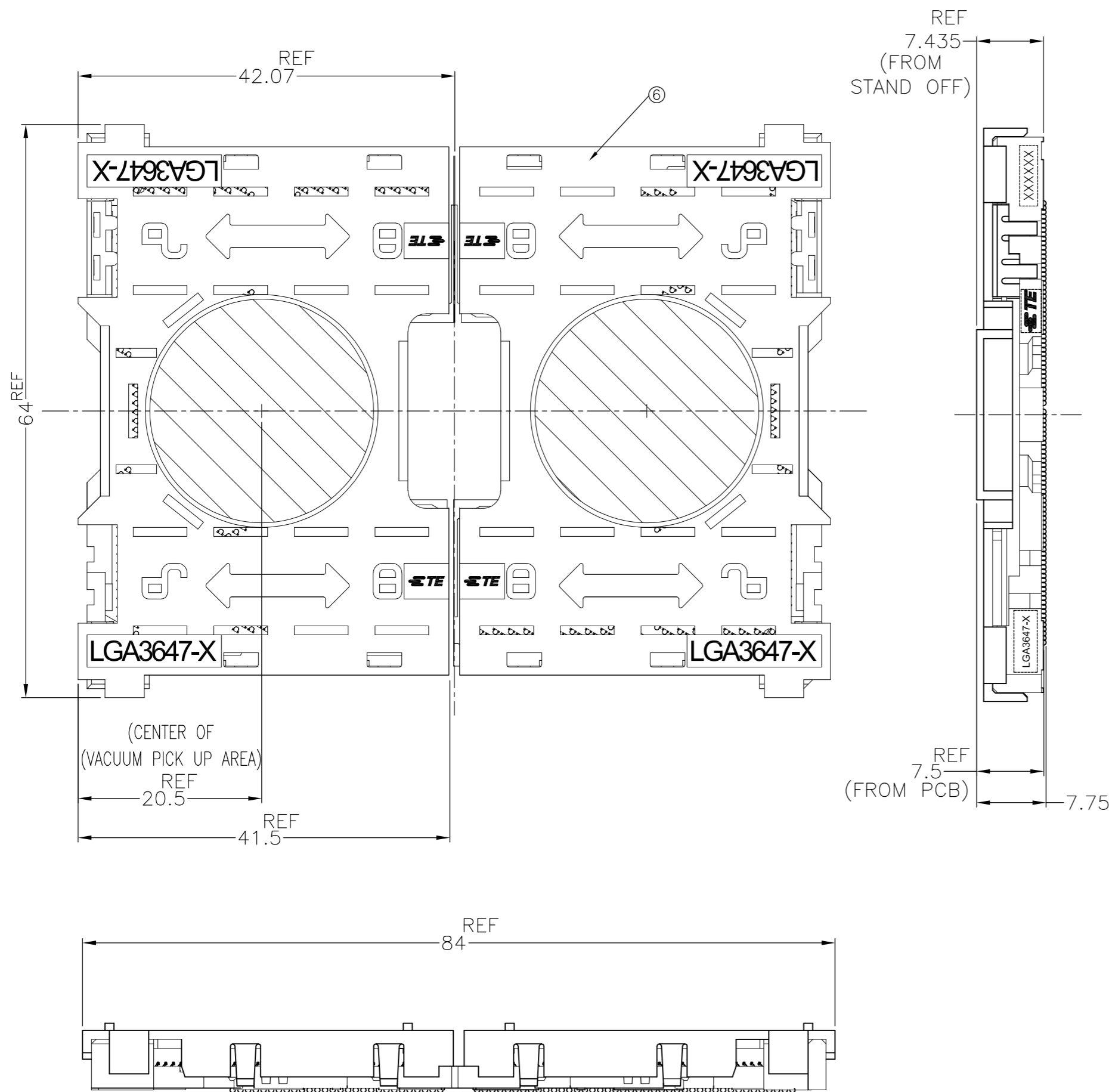

AFTER SMT CONDITION (WITH CAP)
 DEMONSTRATION BY SOCKET P1,LGA3647-1

1. MATERIAL
- ① HOUSING : HIGH TEMP, THERMO-PLASTIC, UL94V-0, BLACK
 - ② CONTACT : COPPER ALLOY
FINISH : Au PL. SHOW AS Δ AT CONTACT AREA
ON OVERALL OVER Ni UNDER PL. 0.00127 MIN.
 - ③ SOLDER BALL : Sn/Ag/Cu
 - ④ KEY HSG LEFT : HIGH TEMP. THERMO-PLASTIC, UL94V-0, BLACK
 - ⑤ KEY HSG RIGHT: HIGH TEMP. THERMO-PLASTIC, UL94V-0, P0 YELLOW, P1 NATURAL
 - ⑥ CAP : HIGH TEMP. THERMO-PLASTIC, UL94V-0, NATURAL
- Δ INDICATED DATE CODE , TYCO LOGO, PRODUCT NAME ON THE HSG
 Δ FOR NORMAL ORDER, LEFT AND RIGHT SEGMENT SHOULD ORDER AT SAME TIME

LGA3647-1 SOCKET P1				LGA3647-0 SOCKET P0				PRODUCT NAME
30u Au PLATING		15u Au PLATING		30u Au PLATING		15u Au PLATING		
LGA3647-1 RIGHT SEGMENT	LGA3647-1 LEFT SEGMENT	LGA3647-1 RIGHT SEGMENT	LGA3647-1 LEFT SEGMENT	LGA3647-0 RIGHT SEGMENT	LGA3647-0 LEFT SEGMENT	LGA3647-0 RIGHT SEGMENT	LGA3647-0 LEFT SEGMENT	
2822980-4	1-2822980-4	2822980-2	1-2822980-2	2822980-3	1-2822980-3	2822980-1	1-2822980-1	ASSY PART NUMBER

14.5	21	17	1	1	1	1	1	2-2129710-8
		16				1		2-2129710-7
	21	17		1				2-2129710-6
		16			1		1	2-2129710-5
								2-2129710-4
								2-2129710-3
								2-2129710-2
							1	2-2129710-1

PRODUCT WEIGHT (g/SOCKET)	DIMENSION D2	DIMENSION D1	QTY.	PACKAGE PART NO.
THIS DRAWING IS A CONTROLLED DOCUMENT.				
DIMENSIONS: mm		TOLERANCES UNLESS OTHERWISE SPECIFIED:		DWN T.KUO 04MAR2015 CHK M.CHAO 04MAR2015 APVD M.CHAO 04MAR2015 PRODUCT SPEC 108-115115 APPLICATION SPEC 114-115011
0-PLC ± 1-PLC ± ±0.3 2-PLC ± ±3 3-PLC ± ±3 4-PLC ± ± ANGLES ± -		MATERIAL FINISH		
MATERIAL		FINISH		NAME: SOCKET ASSY LGA3647-X SIZE: A2 CAGE CODE: 00779 DRAWING NO: C=2129710 WEIGHT: - SCALE: NTS SHEET: 1 OF 7 REV: C
CUSTOMER DRAWING				RESTRICTED TO

THIS DRAWING IS UNPUBLISHED. RELEASED FOR PUBLICATION
 © COPYRIGHT - Tyco Electronics JAPAN G.K. ALL RIGHTS RESERVED.

LOC		DIST		REVISIONS			
P	LTR	DESCRIPTION	DATE	DWN	APVD		
-	-	SEE SHEET 1	-	-	-	-	-

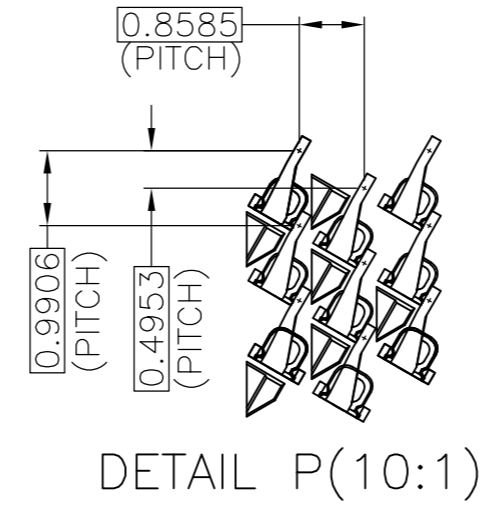
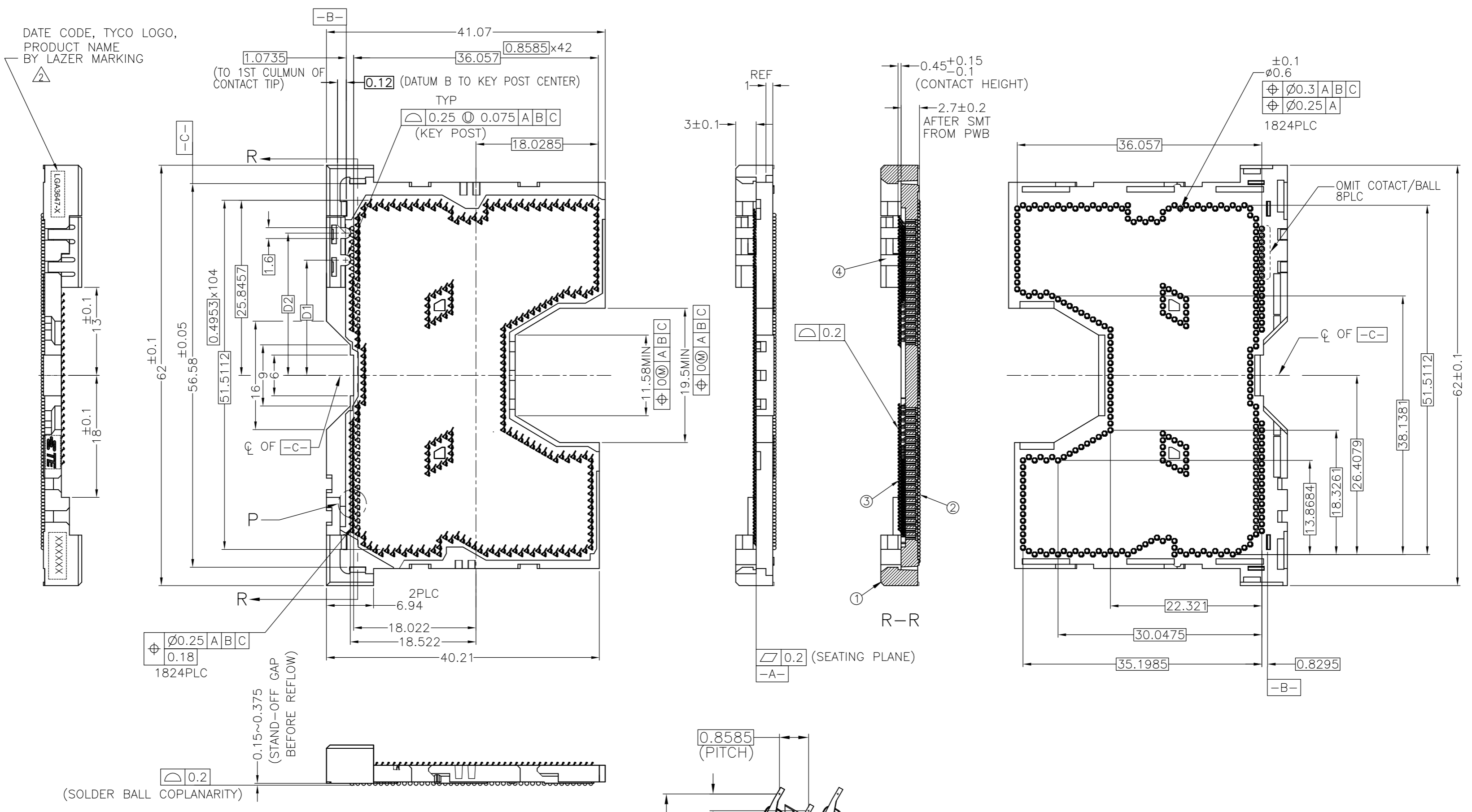

THESE VIEW DON'T SHOW CAP BEFORE SMT CONDITION
 LGA3647-1 LEFT SIDE ASSY
 1-2822980-* AS SHOWN

THIS DRAWING IS A CONTROLLED DOCUMENT.		DWN -	TE Connectivity	
DIMENSIONS: mm		CHK -		
TOLERANCES UNLESS OTHERWISE SPECIFIED:		APVD -	SOCKET ASSY LGA3647-X	
0-PLC ±		PRODUCT SPEC -	SIZE	CAGE CODE
1-PLC ± ±0.3		APPLICATION SPEC -	A2	00779
2-PLC ± ±3		WEIGHT -	DRAWING NO	RESTRICTED TO
3-PLC ± ±3		CUSTOMER DRAWING	C=2129710	-
4-PLC ±		SCALE	NTS	SHEET 2 OF 7
MATERIAL - FINISH -		REV	C	

THIS DRAWING IS UNPUBLISHED. RELEASED FOR PUBLICATION
 © COPYRIGHT - Tyco Electronics JAPAN G.K. ALL RIGHTS RESERVED.

LOC		DIST		REVISIONS			
P	LTR	DESCRIPTION	DATE	DWN	APVD		
-	-	SEE SHEET 1	-	-	-		

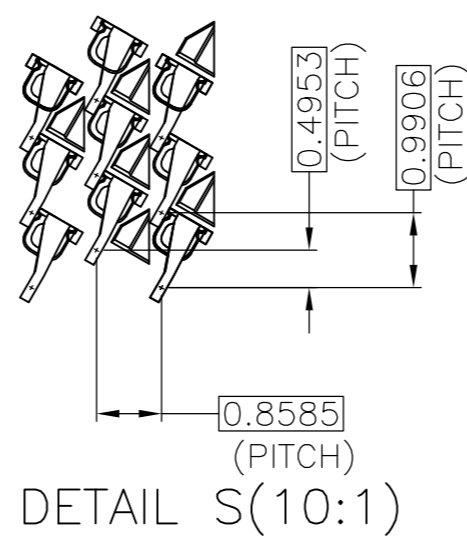
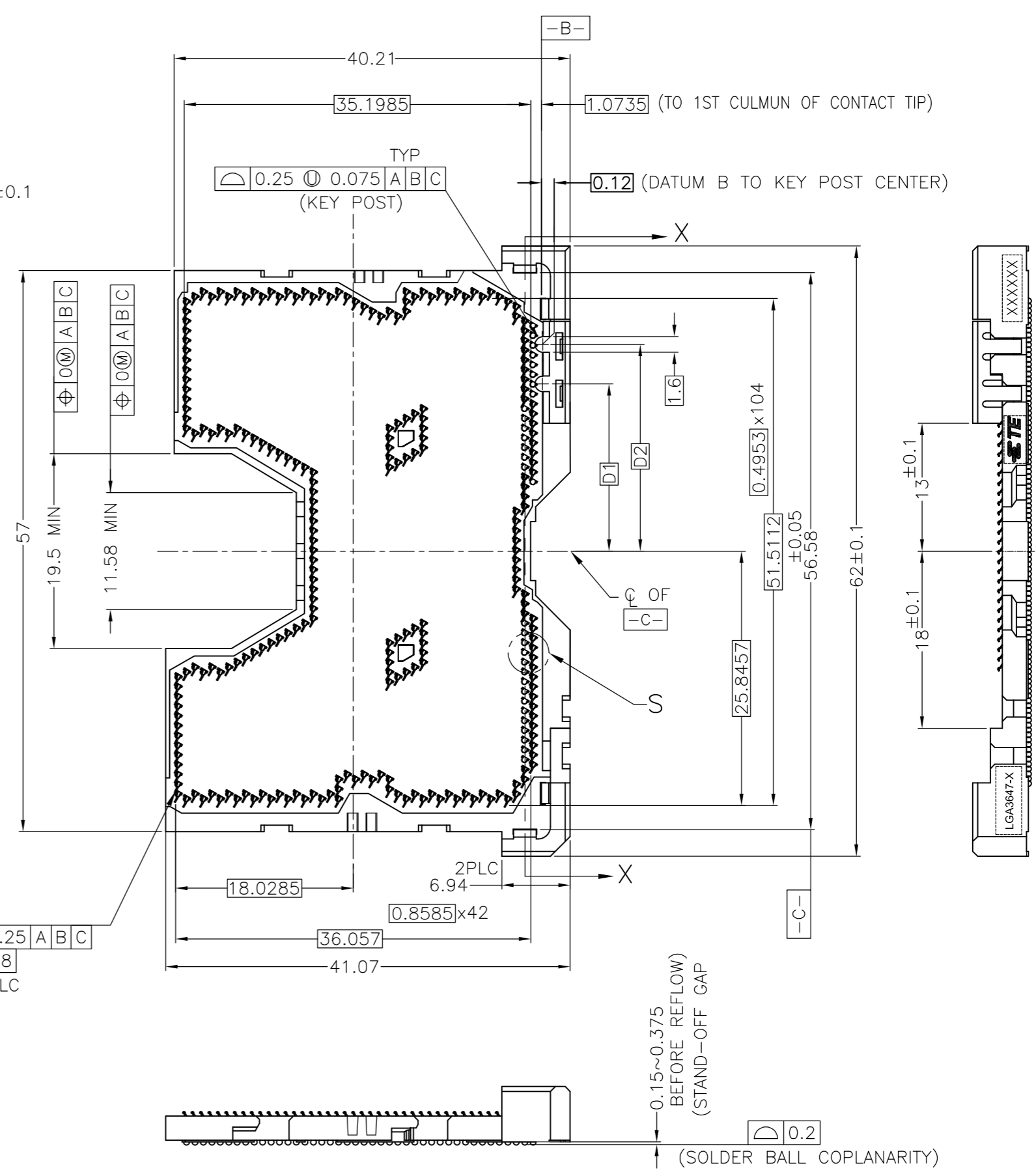
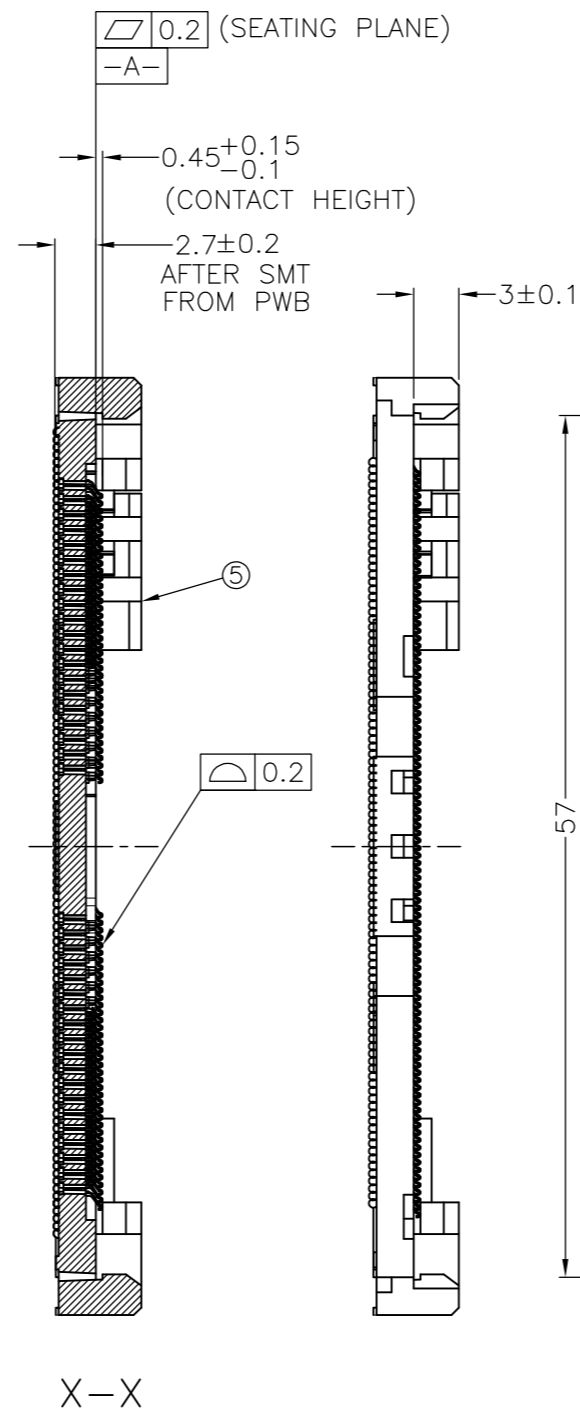
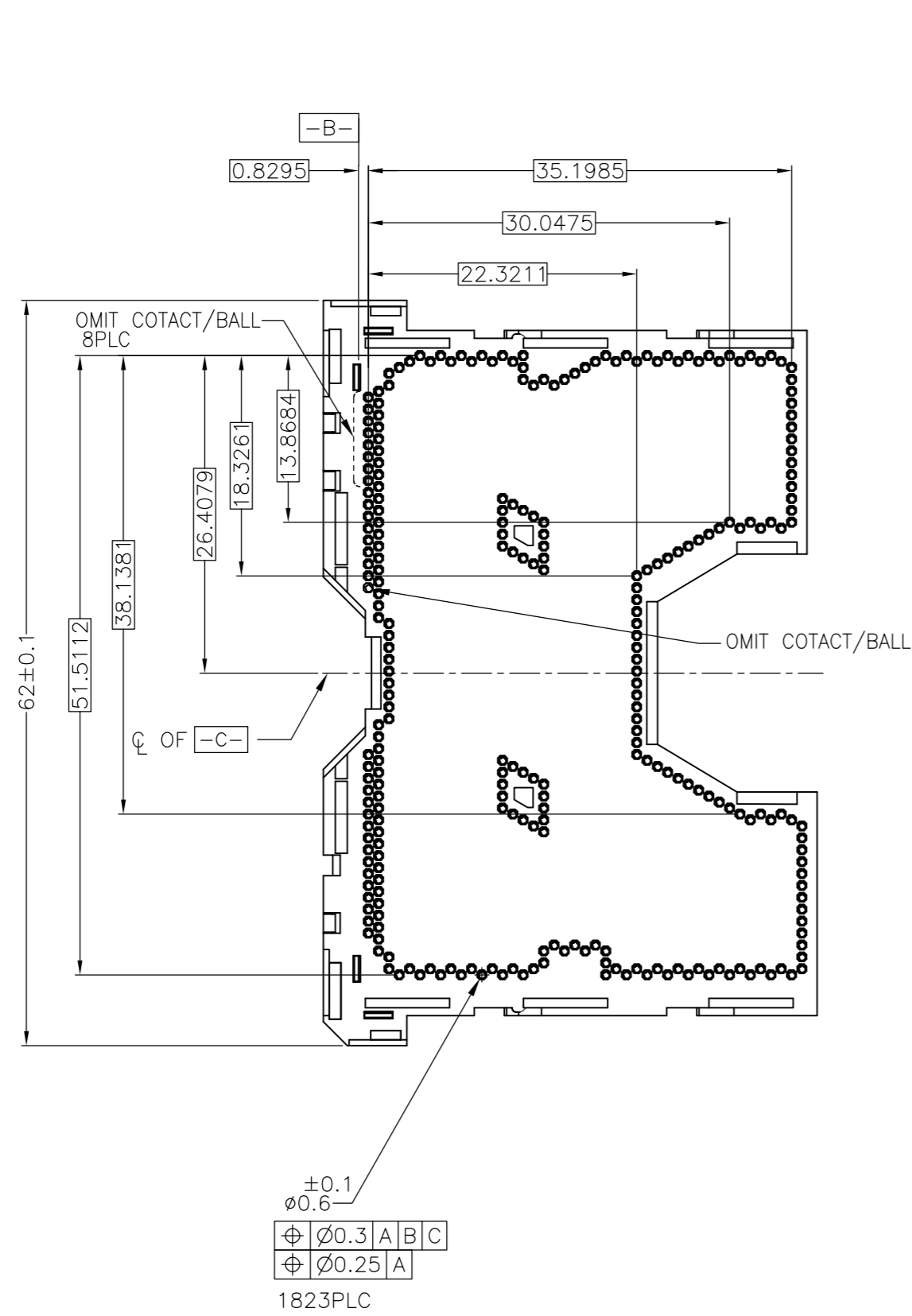

THESE VIEW DON'T SHOW CAP BEFORE SMT CONDITION LGA3647-1 RIGHT SIDE ASSY 2822980-* AS SHOWN

THIS DRAWING IS A CONTROLLED DOCUMENT.		DWN	TE Connectivity	
DIMENSIONS: mm		CHK	NAME	
TOLERANCES UNLESS OTHERWISE SPECIFIED:		APVD	SOCKET ASSY LGA3647-X	
0-PLC ±		PRODUCT SPEC	SIZE	CAGE CODE
1-PLC ± ±0.3		APPLICATION SPEC	A2	00779
2-PLC ± ±3		WEIGHT	DRAWING NO	RESTRICTED TO
3-PLC ±		CUSTOMER DRAWING	C=2129710	-
4-PLC ±		SCALE	NTS	SHEET 3 OF 7
ANGLES ±		REV	C	
FINISH				

THIS DRAWING IS UNPUBLISHED. RELEASED FOR PUBLICATION
 © COPYRIGHT - Tyco Electronics JAPAN G.K. ALL RIGHTS RESERVED.

LOC	DIST	REVISIONS					
		P	LTR	DESCRIPTION	DATE	DWN	APVD
ES	-	-	-	SEE SHEET 1	-	-	-

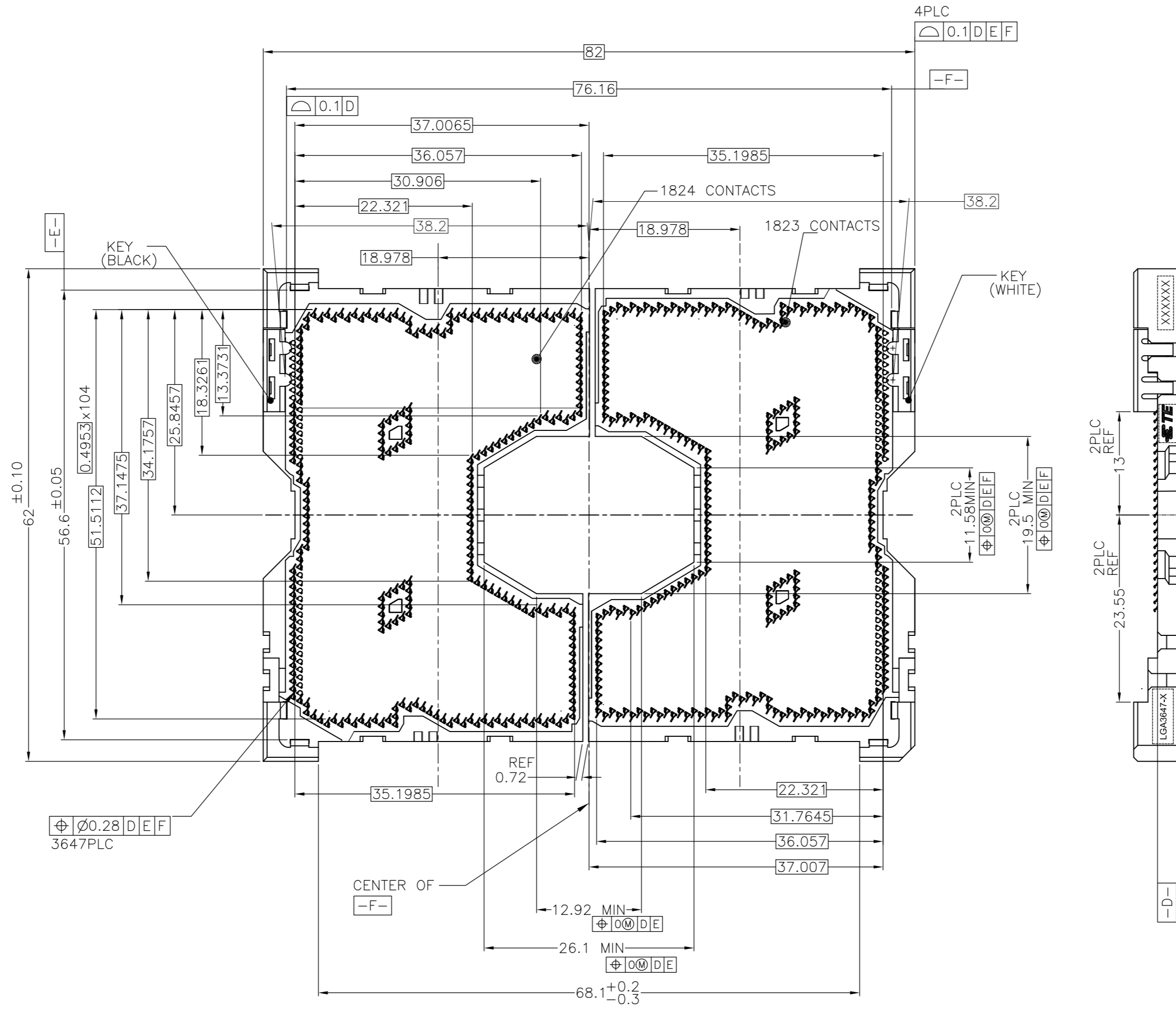

AFTER SMT CONDITION

THIS DRAWING IS A CONTROLLED DOCUMENT.		DWN	-			NAME	
DIMENSIONS: mm		CHK	-			SOCKET ASSY LGA3647-X	
TOLERANCES UNLESS OTHERWISE SPECIFIED:		APVD	-	PRODUCT SPEC	-	SIZE	A2
0-PLC ± 1-PLC ± 2-PLC ±0.3 3-PLC ±3.0 4-PLC ± ANGLES ±		APPLICATION SPEC	-	CAGE CODE	00779	DRAWING NO	C=2129710
MATERIAL		WEIGHT	-	RESTRICTED TO	-	SCALE	NTS
FINISH		CUSTOMER DRAWING	-	SHEET	4 OF 7	REV	C

THIS DRAWING IS UNPUBLISHED. RELEASED FOR PUBLICATION
 © COPYRIGHT - Tyco Electronics JAPAN G.K. ALL RIGHTS RESERVED.

LOC		DIST		REVISIONS			
P	LTR	DESCRIPTION	DATE	DWN	APVD		
-	-	SEE SHEET 1	-	-	-		

D

C

B

A

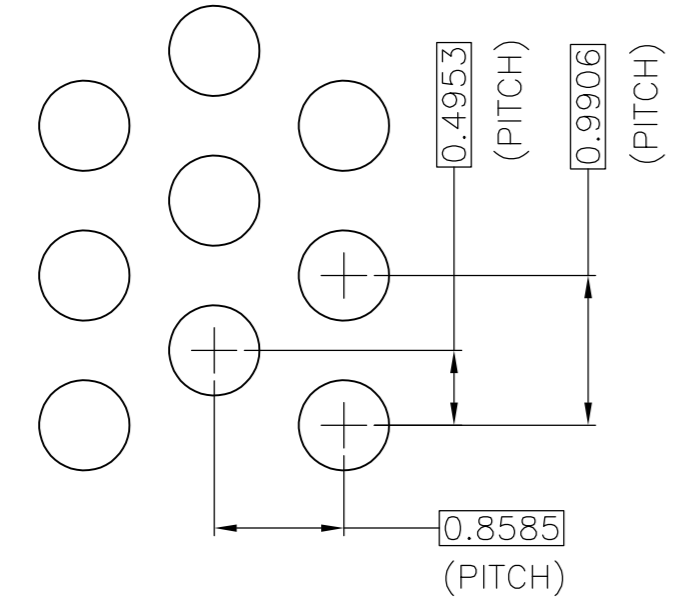
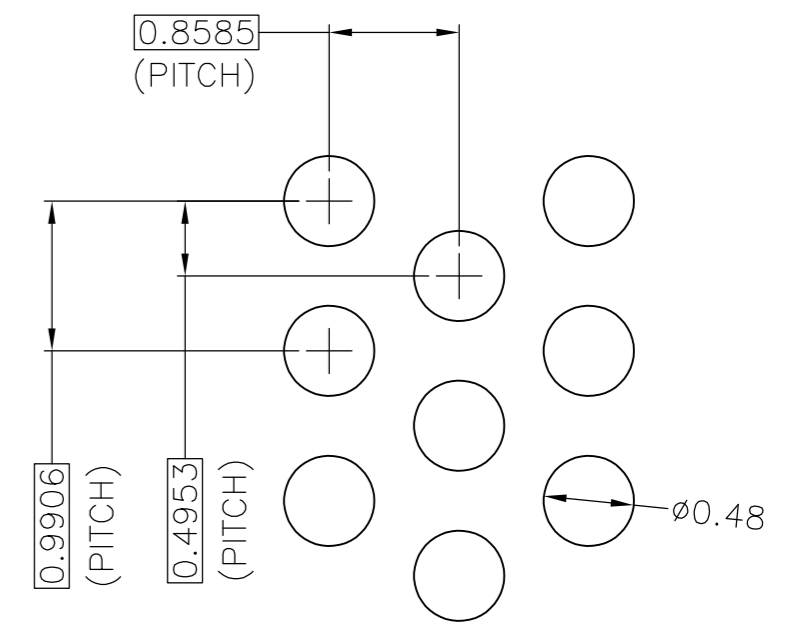
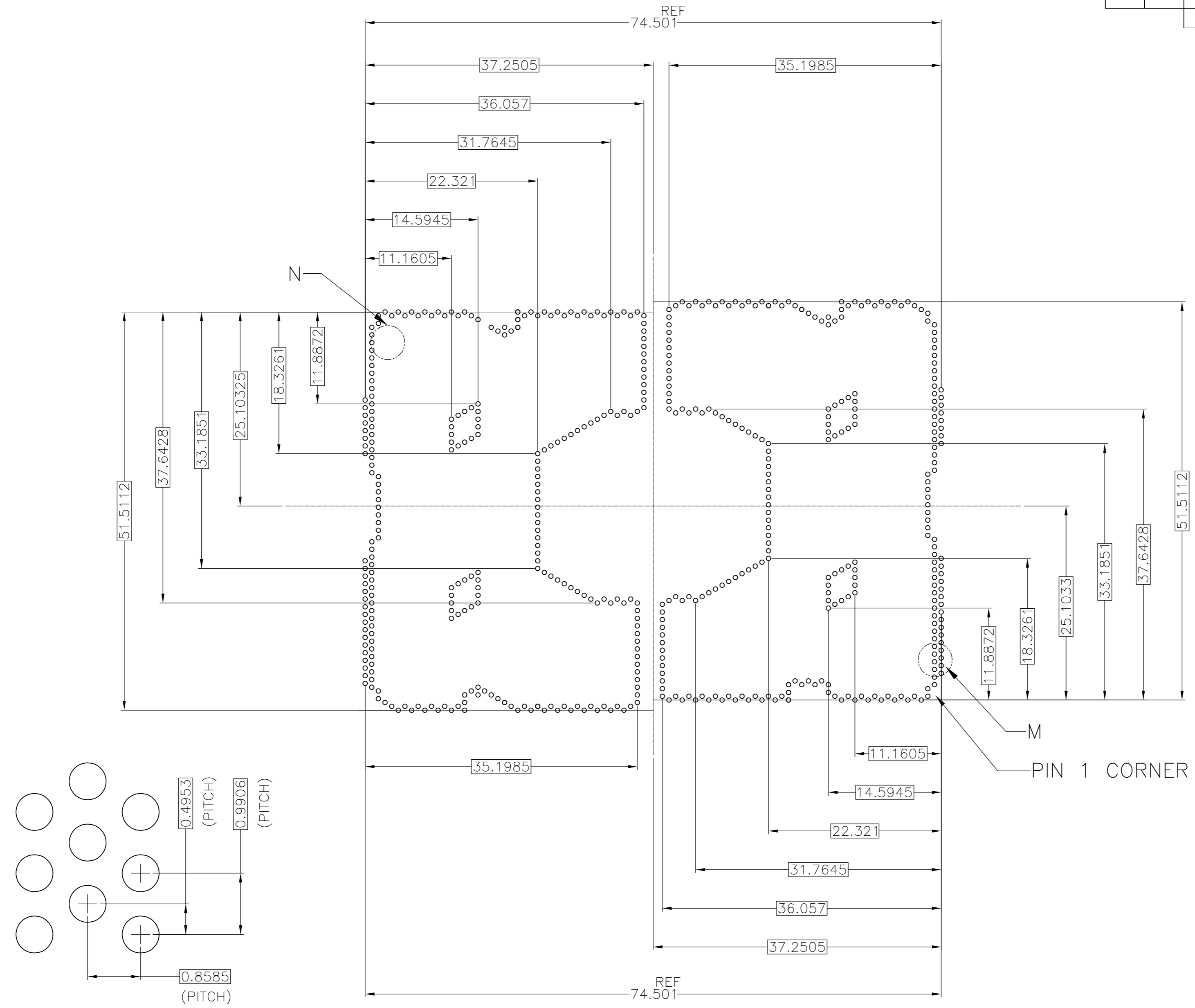

THIS DRAWING IS A CONTROLLED DOCUMENT.		DWN	-		
DIMENSIONS: mm		CHK	-		
TOLERANCES UNLESS OTHERWISE SPECIFIED:		APVD	-		
0-PLC ±		NAME	-		
1-PLC ± ±0.3		PRODUCT SPEC	-		
2-PLC ± ±3		APPLICATION SPEC	-		
3-PLC ±		SIZE	A2	CAGE CODE	00779
4-PLC ±		DRAWING NO	C=2129710		RESTRICTED TO
ANGLES ± -		WEIGHT	-		
FINISH		CUSTOMER DRAWING		SCALE	NTS
-		SHEET		5 of 7	REV
-		-		C	



SOCKET ASSY
LGA3647-X

THIS DRAWING IS UNPUBLISHED. RELEASED FOR PUBLICATION
 © COPYRIGHT - Tyco Electronics JAPAN G.K. ALL RIGHTS RESERVED.

LOC	DIST	REVISIONS					
		P	LTR	DESCRIPTION	DATE	DWN	APVD
ES	-	-	-	SEE SHEET 1	-	-	-

SOCKET P0,LGA3647-0 AS SHOWN

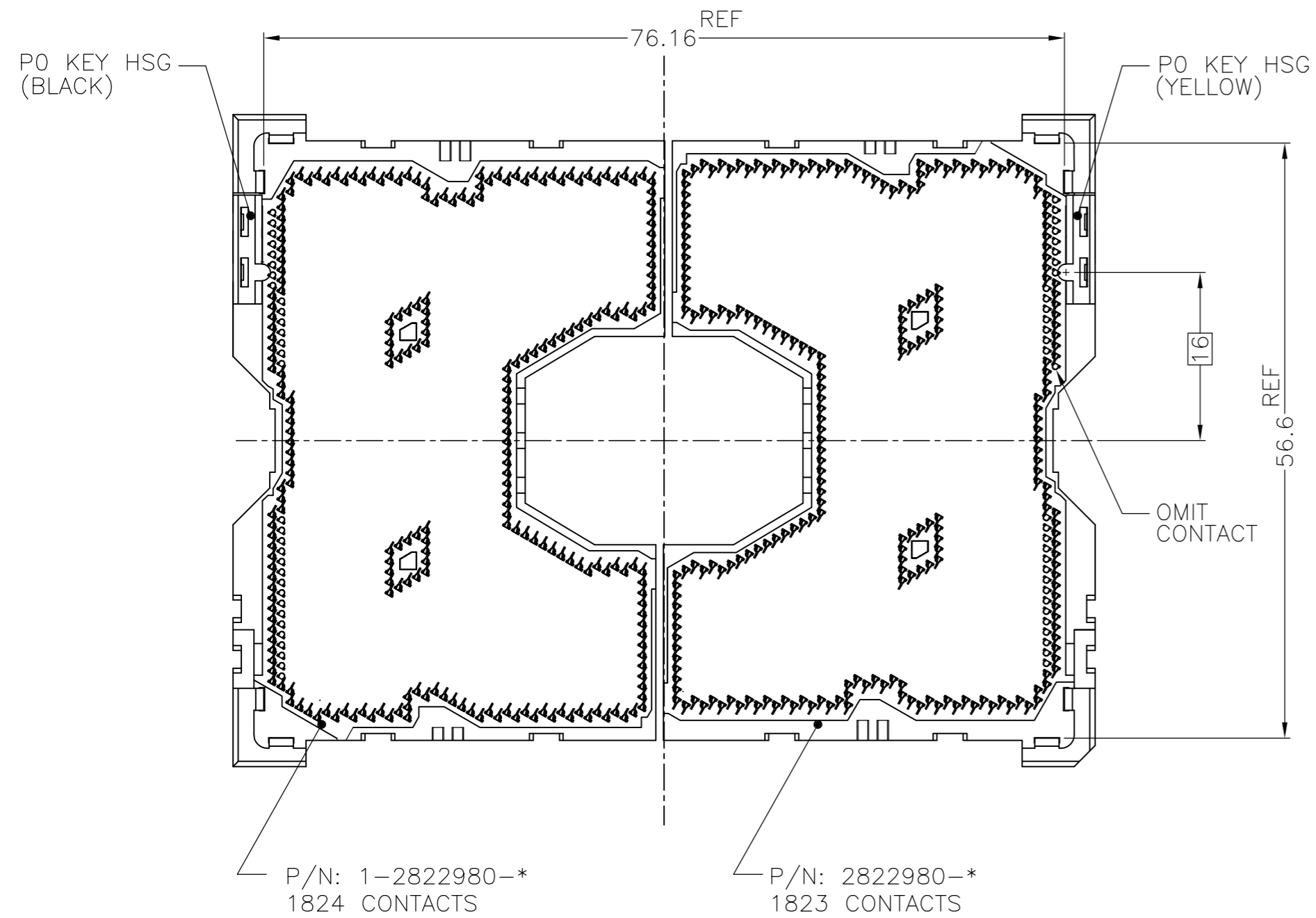

LGA3647-0 AS SHOWN
(KIT P/N: 2-2822979-*)

SOCKET P1,LGA3647-1 AS SHOWN

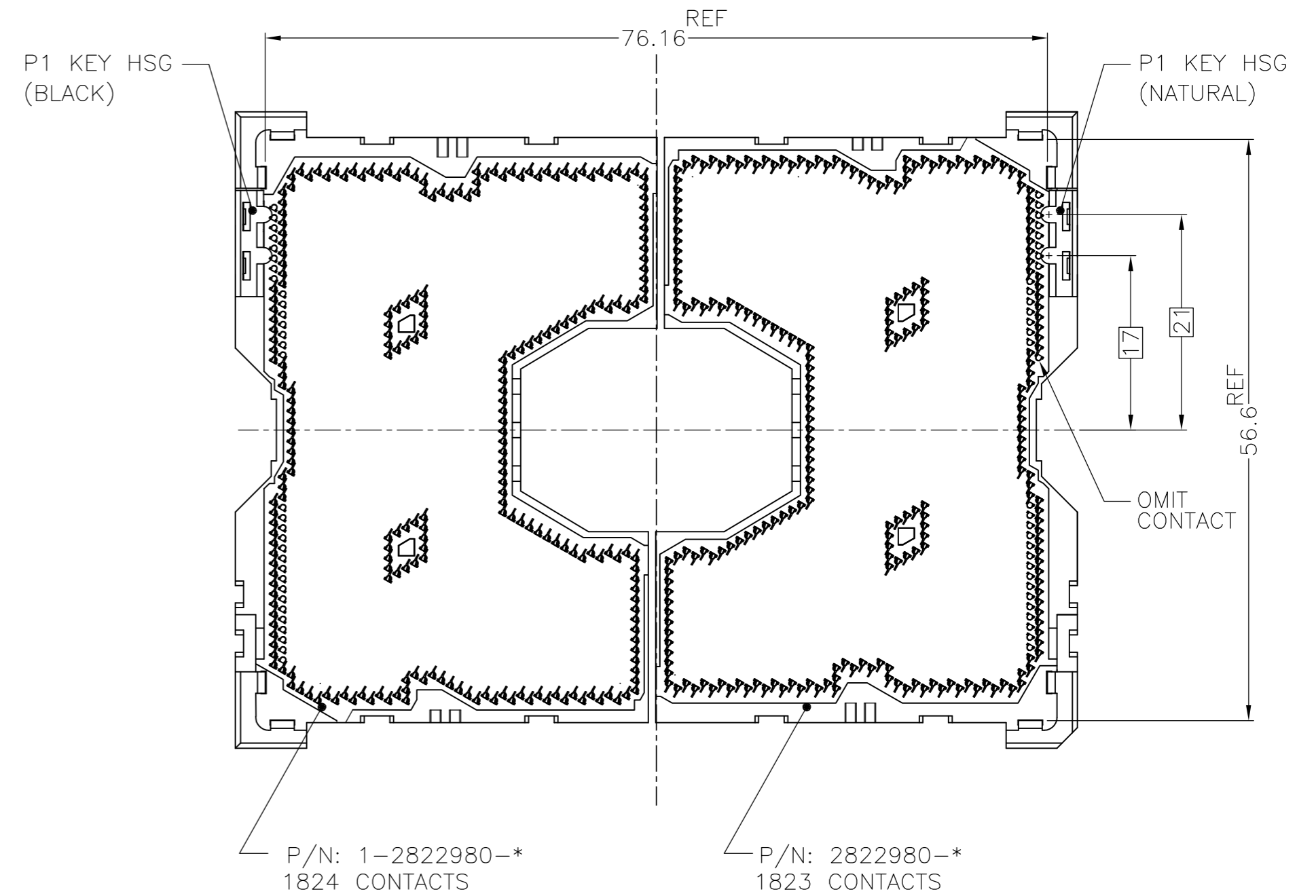

LGA3647-1 AS SHOWN
(KIT P/N: 2-2822979-*)

LGA3647-X POST SMT CONDITION
(PCB IS NOT SHOWN)

THIS DRAWING IS A CONTROLLED DOCUMENT.		DWN	TE Connectivity		
DIMENSIONS: mm		CHK	NAME		
TOLERANCES UNLESS OTHERWISE SPECIFIED:		APVD	SOCKET ASSY LGA3647-X		
0-PLC ±		PRODUCT SPEC	SIZE	CAGE CODE	DRAWING NO
1-PLC ± ±0.3		APPLICATION SPEC	A2	00779	C=2129710
2-PLC ± ±3		WEIGHT	RESTRICTED TO		
3-PLC ± ±		CUSTOMER DRAWING	-		
4-PLC ± ±		SCALE	NTS	SHEET	6 OF 7
MATERIAL		FINISH	REV C		

THIS DRAWING IS UNPUBLISHED. RELEASED FOR PUBLICATION
 © COPYRIGHT - Tyco Electronics JAPAN G.K. ALL RIGHTS RESERVED.

LOC		DIST		REVISIONS			
P	LTR	DESCRIPTION		DATE	DWN	APVD	
-	-	SEE SHEET 1		-	-	-	

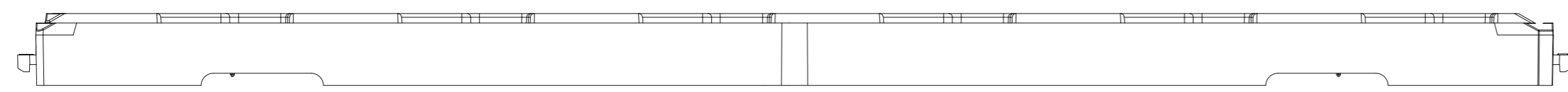
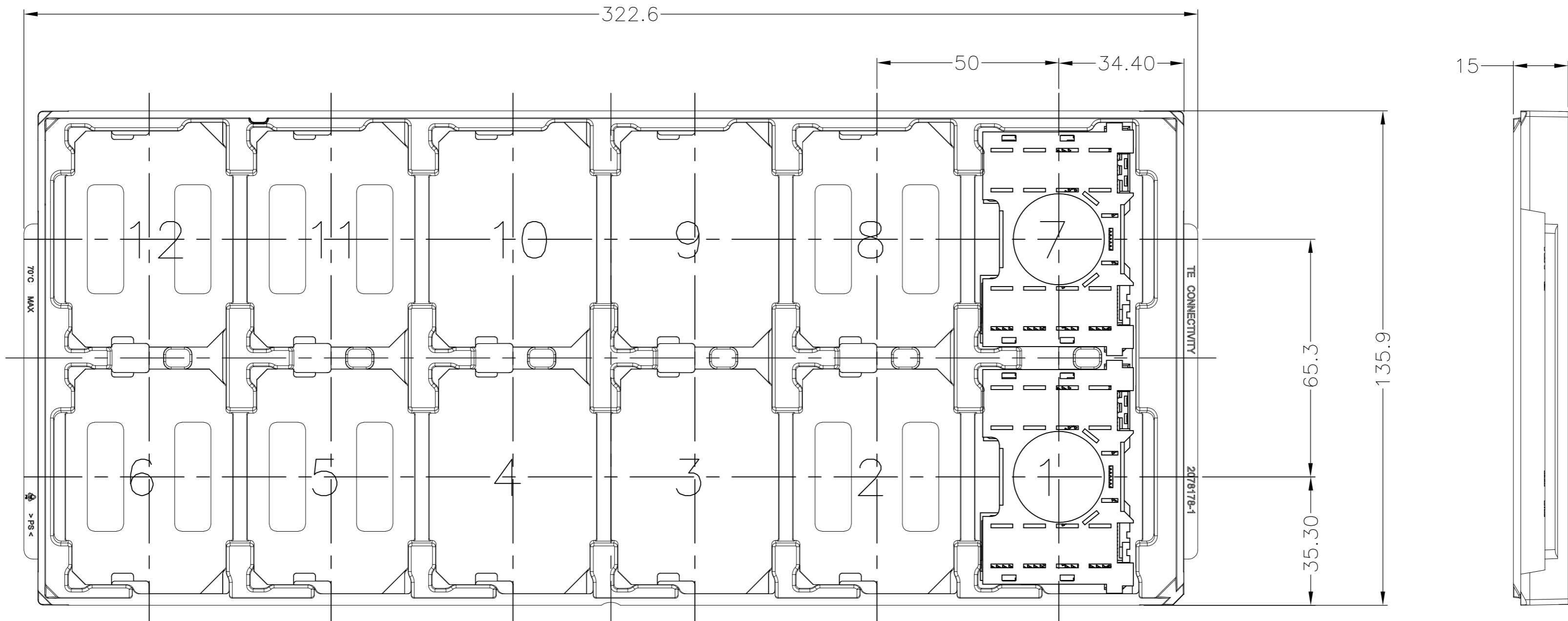

FOR LEFT SEGMENT, USE BLACK TRAY TO PACKAGE.
 FOR RIGHT SEGMENT, USE BLUE TRAY TO PACKAGE.

168	84	12	2822980-4	2-2129710-8	LGA3647-1 RIGHT SEGMENT	LGA3647-1 SOCKET P1
168	84	12	1-2822980-4	2-2129710-7	LGA3647-1 LFFT SEGMENT	LGA3647-1 SOCKET P0
168	84	12	2822980-3	2-2129710-6	LGA3647-0 RIGHT SEGMENT	LGA3647-0 SOCKET P1
168	84	12	1-2822980-3	2-2129710-5	LGA3647-0 LFFT SEGMENT	LGA3647-0 SOCKET P0
168	84	12	2822980-2	2-2129710-4	LGA3647-1 RIGHT SEGMENT	LGA3647-1 SOCKET P1
168	84	12	1-2822980-2	2-2129710-3	LGA3647-1 LFFT SEGMENT	LGA3647-1 SOCKET P0
168	84	12	2822980-1	2-2129710-2	LGA3647-0 RIGHT SEGMENT	LGA3647-0 SOCKET P1
168	84	12	1-2822980-1	2-2129710-1	LGA3647-0 LFFT SEGMENT	LGA3647-0 SOCKET P0
SOCKET QTY PER OUTER BOX	SOCKET QTY PER INNER BOX	SOCKET QTY PER TRAY	ASSY PART NUMBER	ORDER PART NUMBER	PRODUCT NAME	

THIS DRAWING IS A CONTROLLED DOCUMENT.

DWN	-	 TE Connectivity SOCKET ASSY LGA3647-X	NAME	
CHK	-		SIZE	A2
APVD	-		CAGE CODE	00779
PRODUCT SPEC	-		DRAWING NO	C=2129710
APPLICATION SPEC	-	WEIGHT	-	RESTRICTED TO
MATERIAL	-	CUSTOMER DRAWING	SCALE	NTS
TOLERANCES UNLESS OTHERWISE SPECIFIED:	±0.5	FINISH	-	SHEET
0-PLC ±				7 of 7
1-PLC ±				REV
2-PLC ±				C
3-PLC ±				
4-PLC ±				
ANGLES ±				

单击下面可查看定价，库存，交付和生命周期等信息

[>>TE Connectivity\(泰科\)](#)