

LOC		DIST		REVISIONS			
P	LTN	DESCRIPTION	DATE	DWN	APVD		
C		REVISED PER ECR-21-100678	08APR2021	SS	VS		

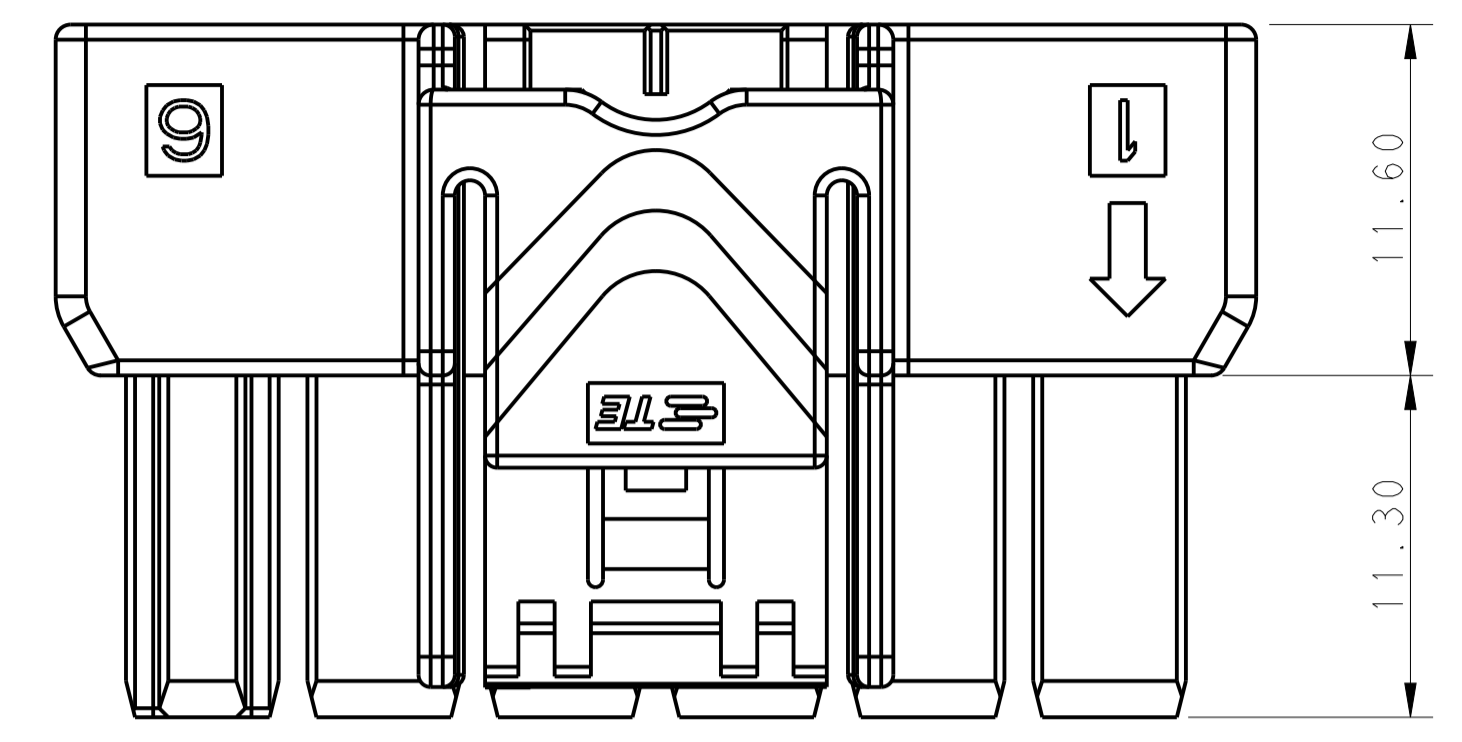

POS.	DIM. A
2*6	39.70
2*5	33.70
2*4	27.70
2*3	21.70

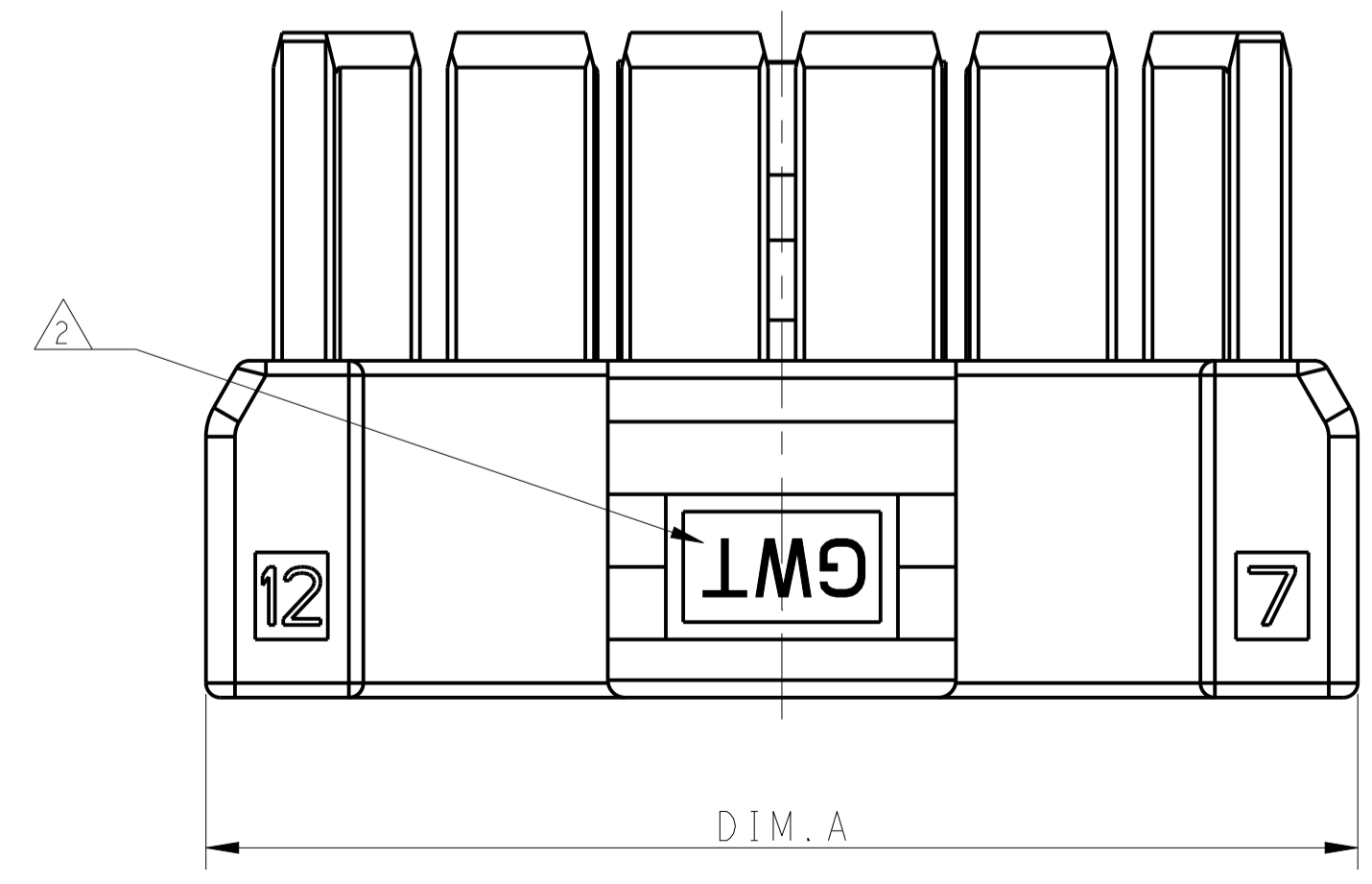
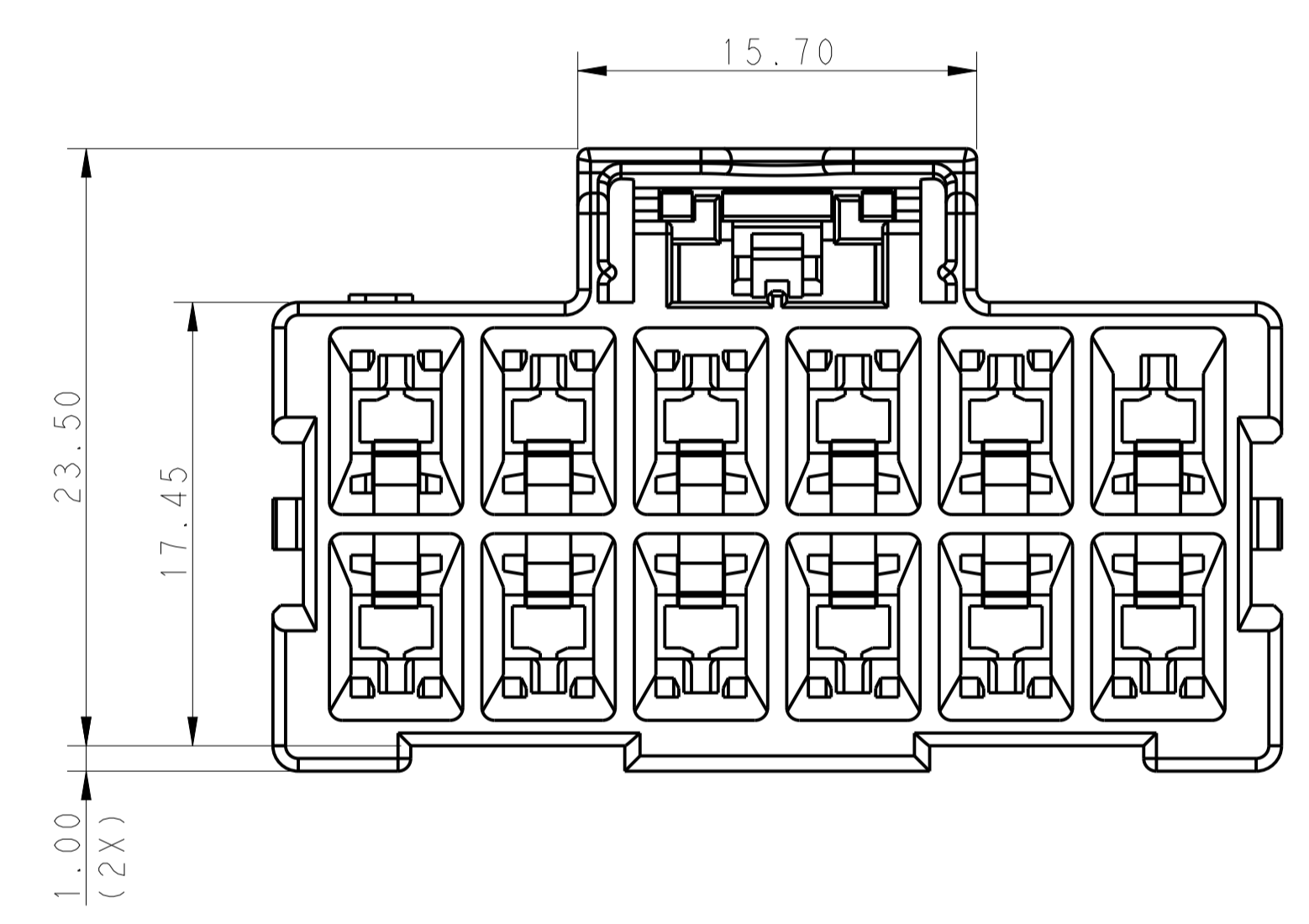
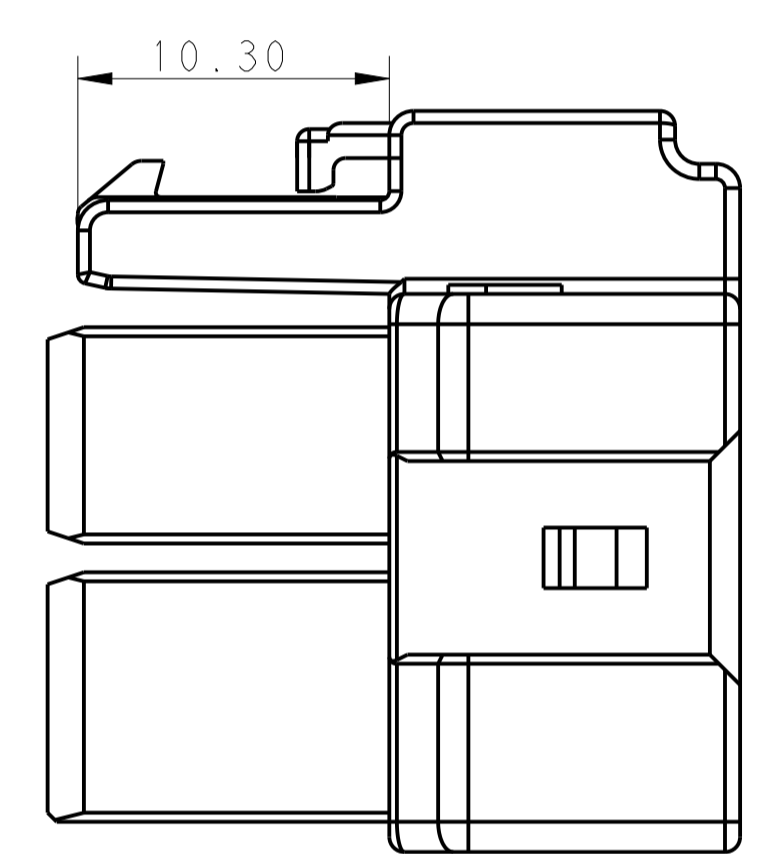
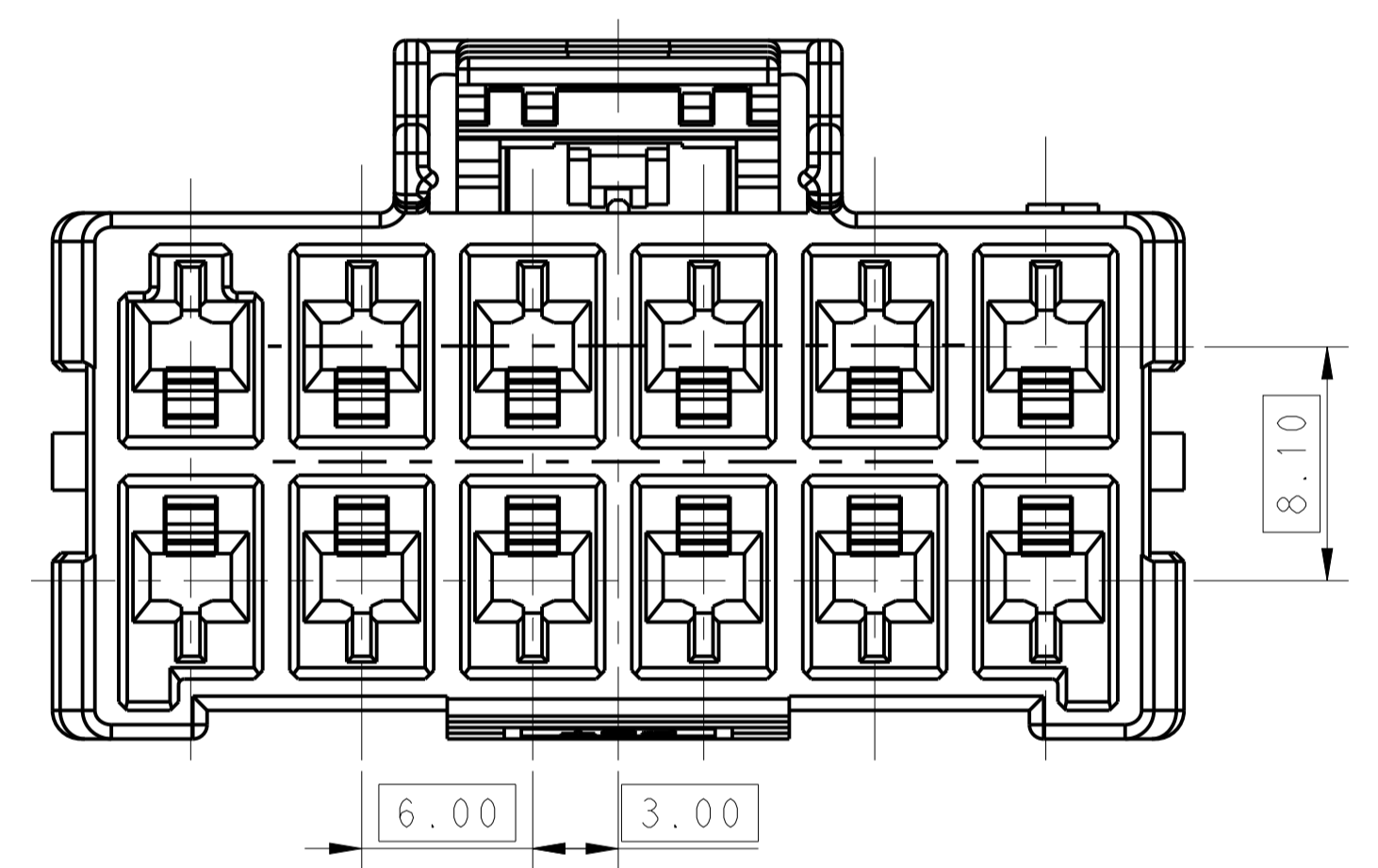

- NOTE
- MATERIAL:
    - LEVEL A: PA6, COMPLY WITH GLOW WIRE REQUIREMENTS FOR PARTS OF NON-METALLIC MATERIAL SUPPORTING A CURRENT-CARRYING CONNECTION DETAILED IN IEC 60335-1, SECTION 30 (GWT), UL 94V-0
    - LEVEL B: PBT, HOT WIRE IGNITION (HWI) VERSION ARE MOLDED IN A RESIN THAT COMPLIES WITH TE PENDING HOT WIRE IGNITION TEST AND ARE RECOMMENDED FOR USE WITH HWI HOUSINGS THAT ALSO COMPLY, UL 94V-0
  - MATERIAL MARK:
    - LEVEL A:GWT,LEVEL B:HWT
  - APPLICABLE CONTACT P/N  
RECEPTACLE CONTACT: 1971237/1971779/81/83/85/87-\*, 2238066-\*
  - MATING CONN, P/N  
CAP HSG: \*-2232359/264-  
TPA: \*-1971778-\*

THIS DRAWING IS A CONTROLLED DOCUMENT.		DWG: TOMMY WU 26MAR2013		TE Connectivity	
DIMENSIONS: mm		CHK: HAPYE WU 26MAR2013			
TOLERANCES UNLESS OTHERWISE SPECIFIED:		APVD: YIHONG MAO 26MAR2013		NAME: PLUG HOUSING, DOUBLE ROW POWER TRIPLE LOCK	
0 PLC ±		PRODUCT SPEC		SIZE: A1	
1 PLC ±0.35		APPLICATION SPEC		CAGE CODE: 2232266	
2 PLC ±0.25		114-106118		RESTRICTED TO	
3 PLC ±		WEIGHT		SCALE: -	
4 PLC ±		Customer Drawing		SHEET 1 OF 2	
ANGLES ±				REV C	
FINISH					

LOC		DIST		REVISIONS			
P	LTN	DESCRIPTION	DATE	OWN	APVD		
-	-	SEE SHEET 1	-	-	-	-	-

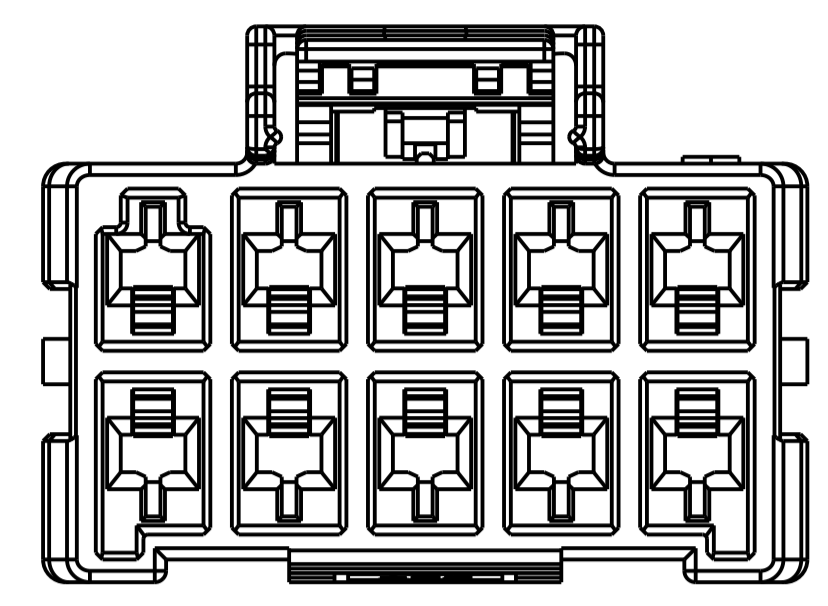
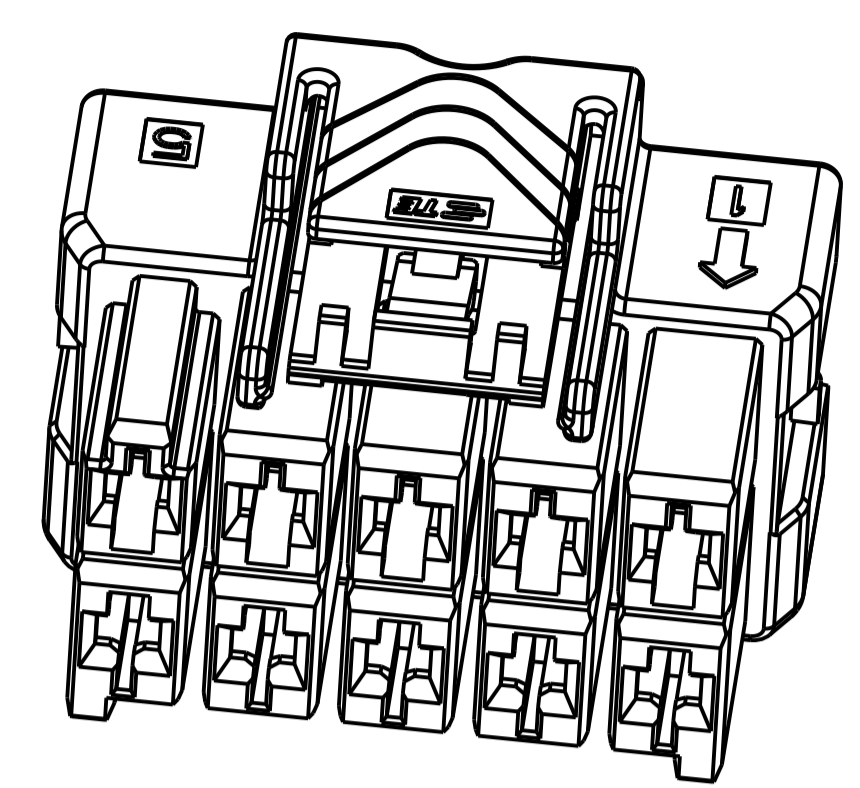

2\*5 POSITIONS

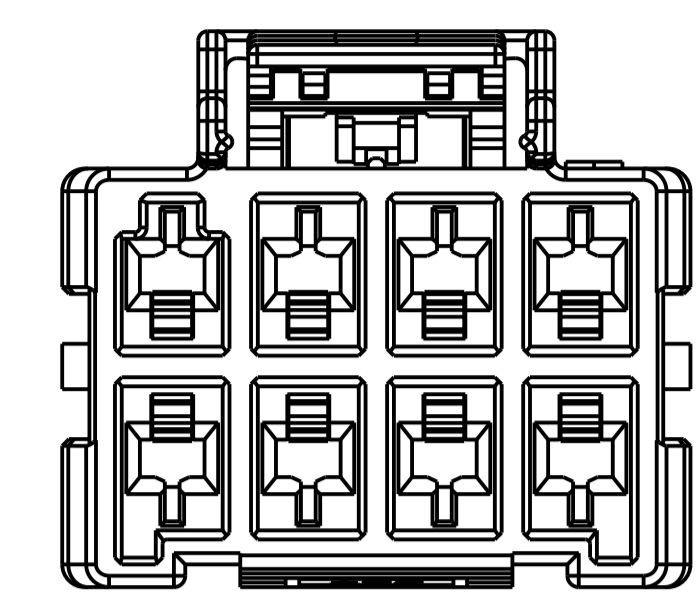
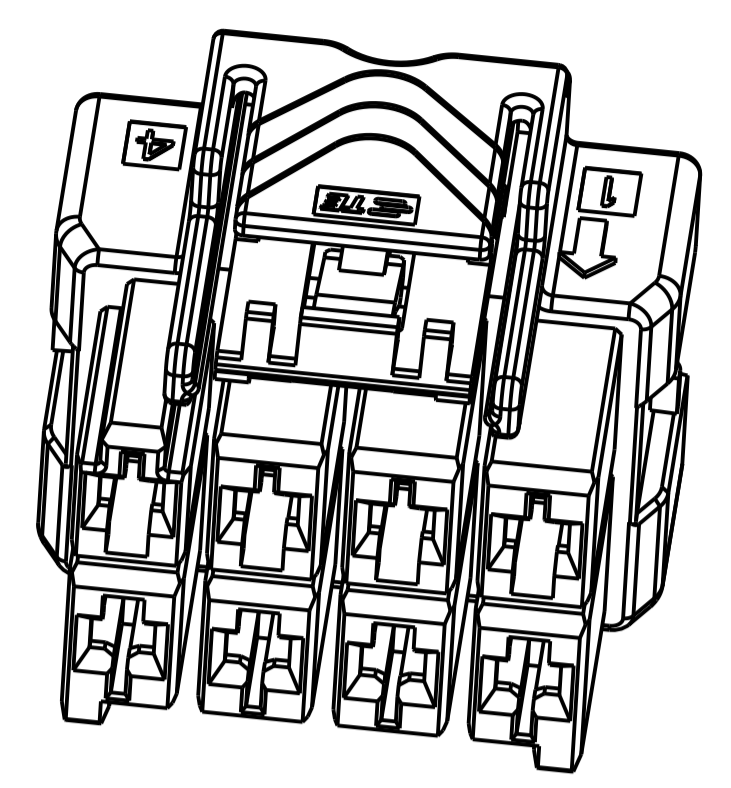

2\*4 POSITIONS

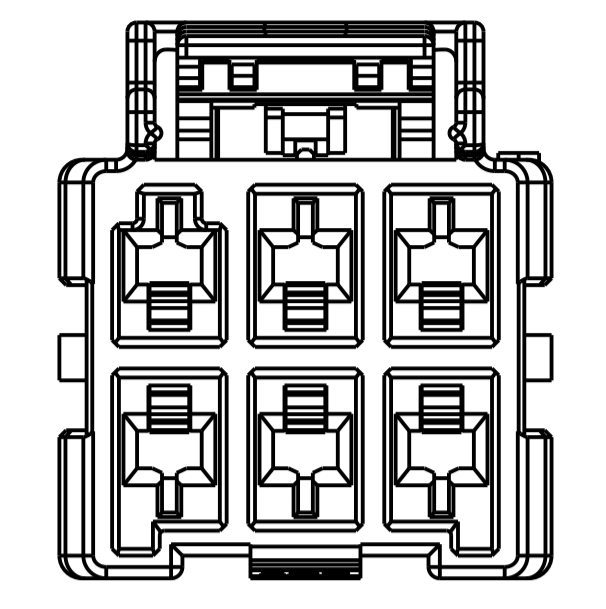
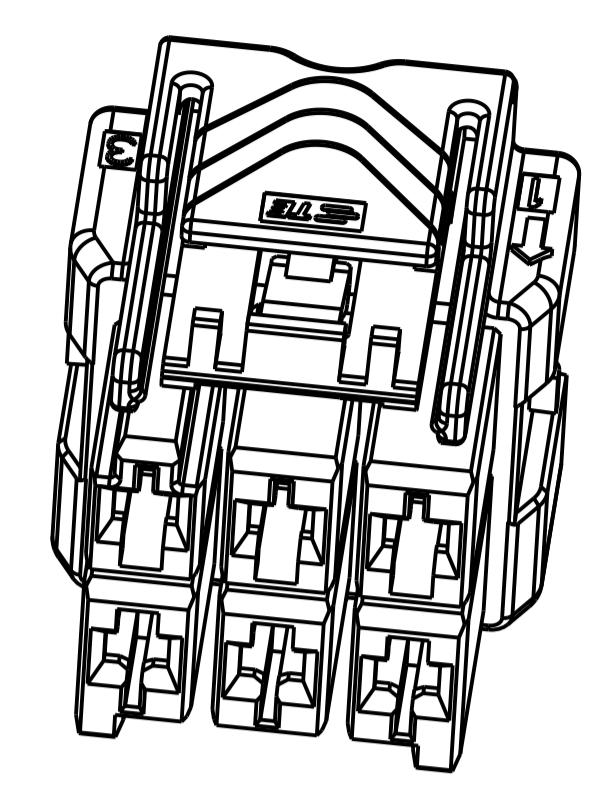

2\*3 POSITIONS

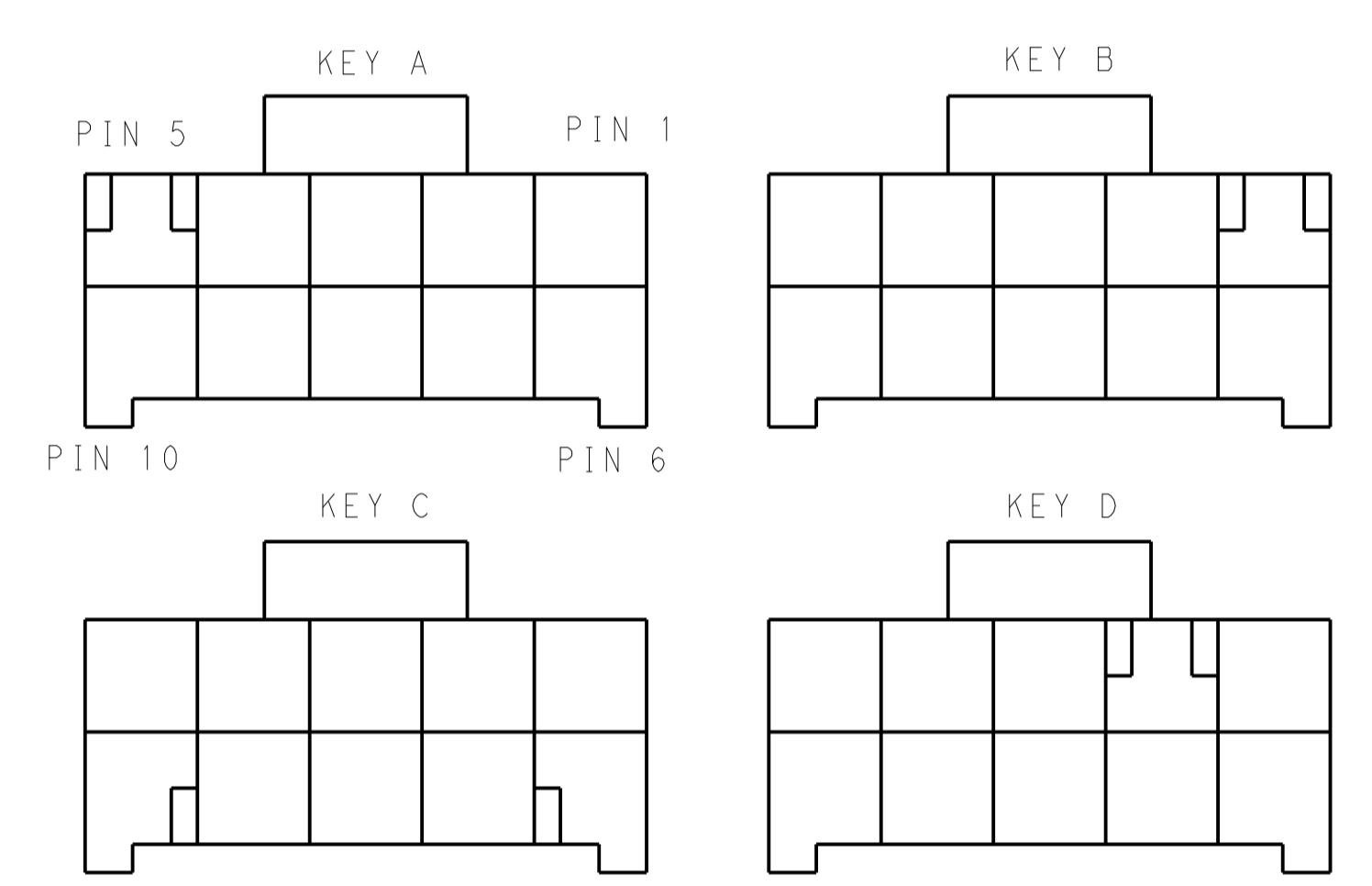

KEYING FOR 2\*5 POS.

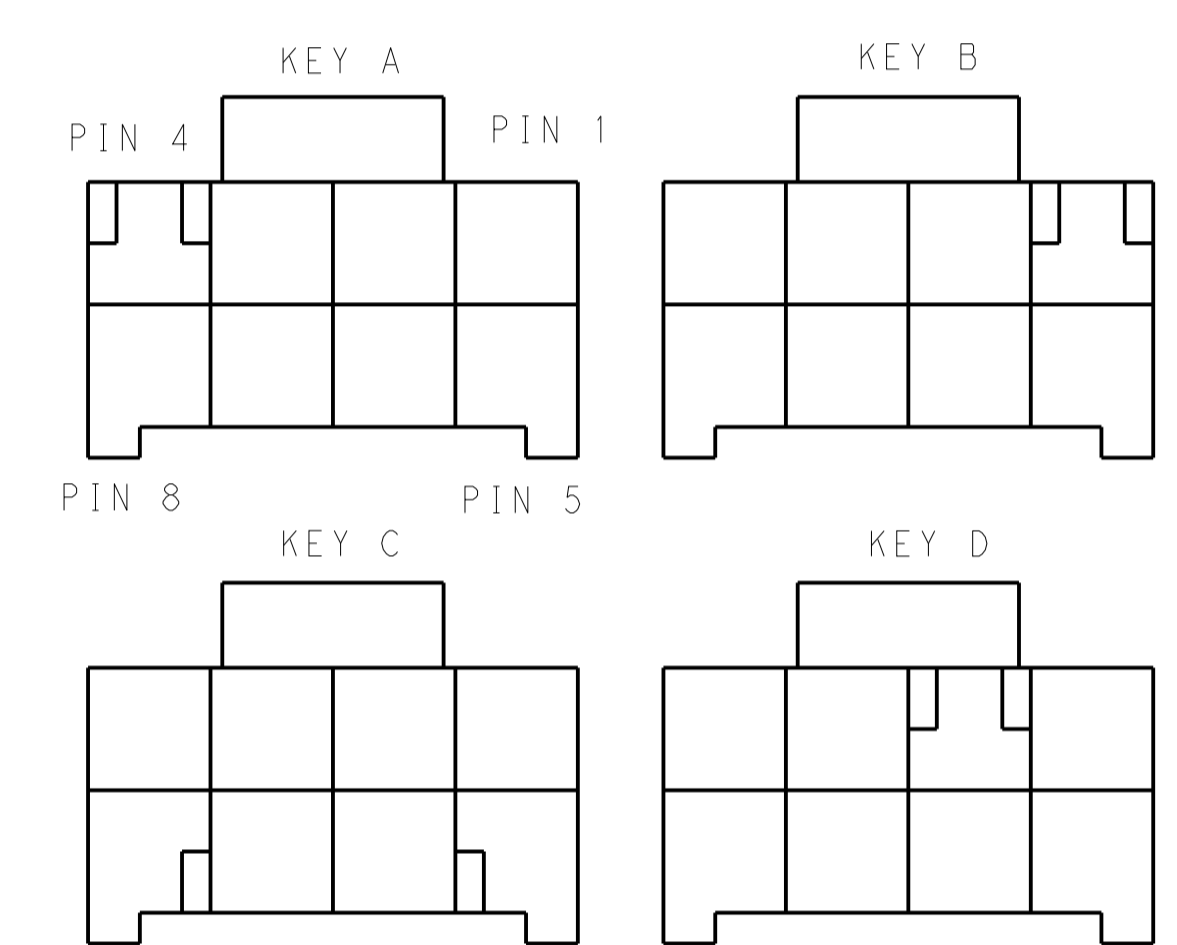

KEYING FOR 2\*4 POS.

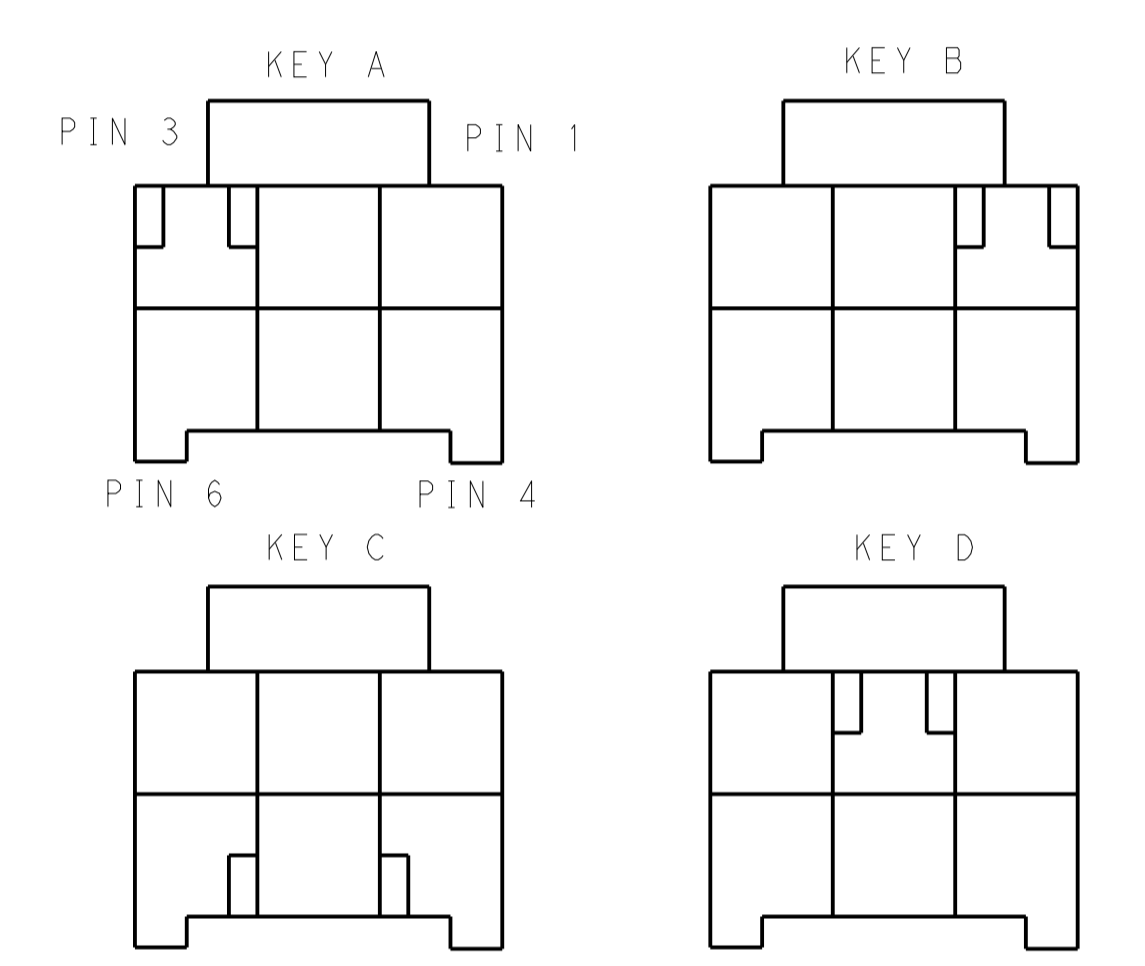

KEYING FOR 2\*3 POS.

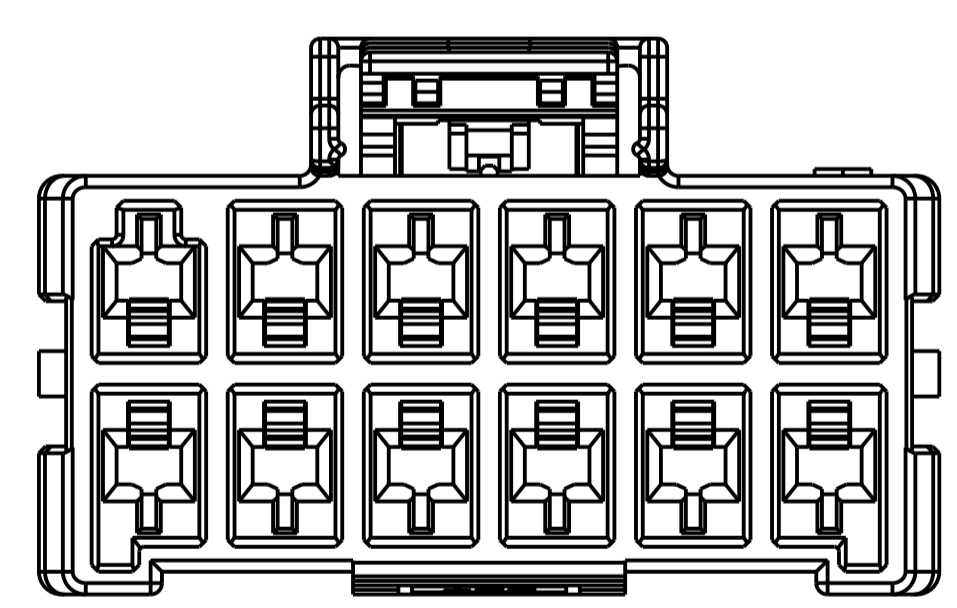
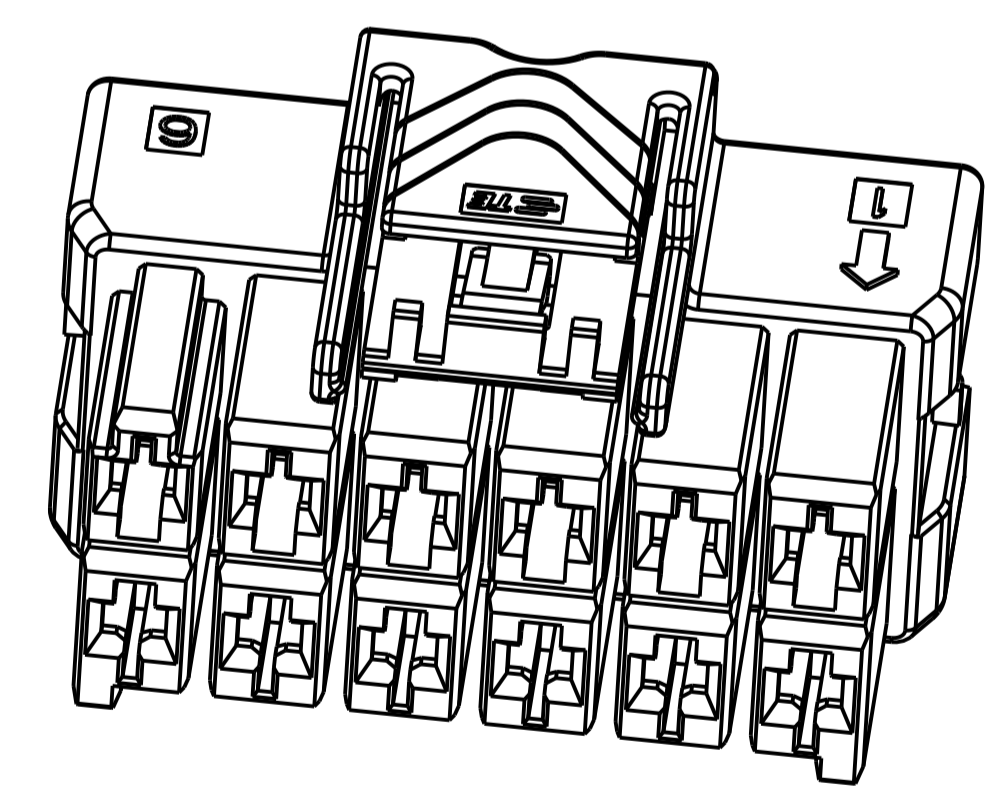

2\*6 POSITIONS

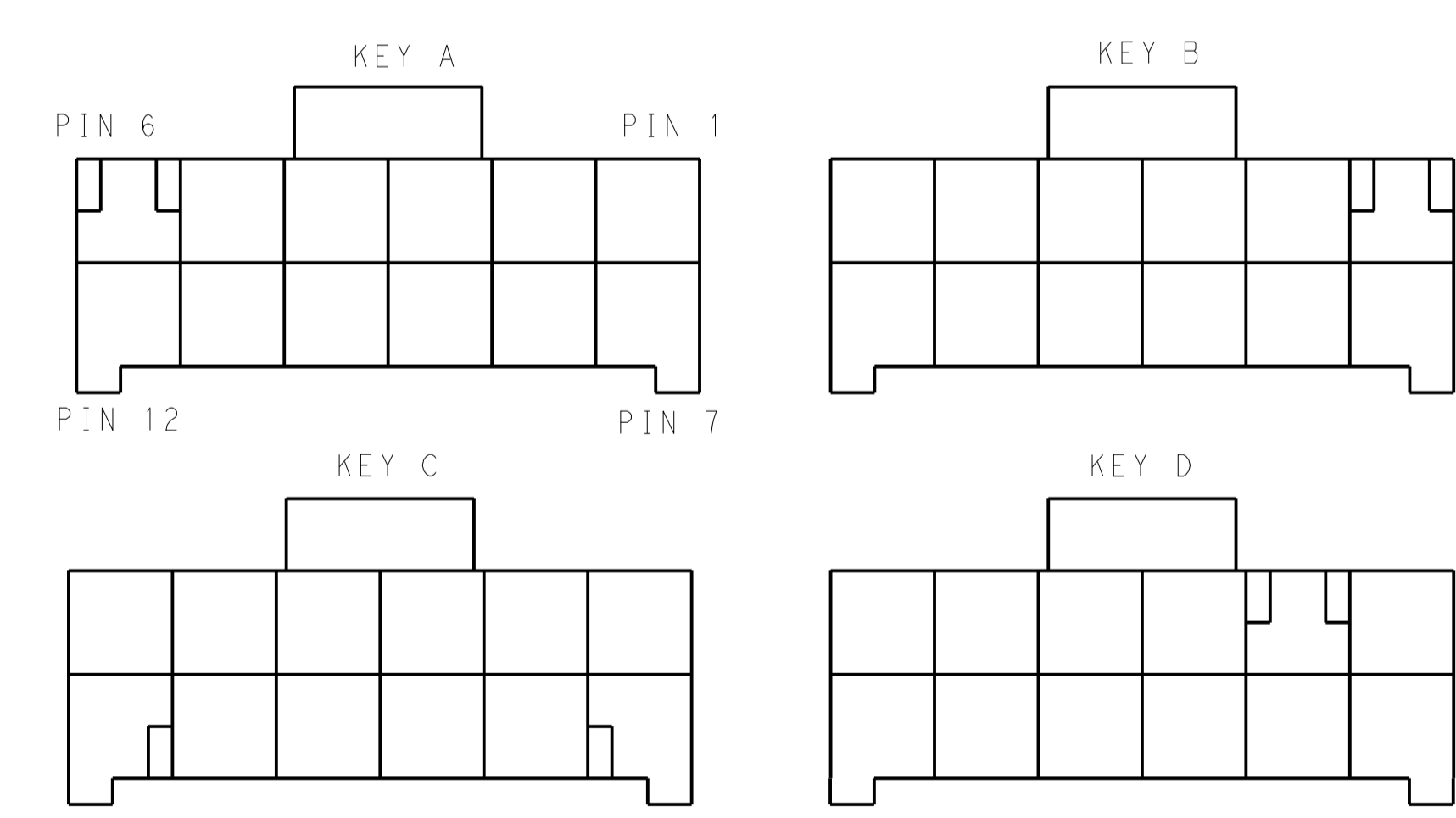

KEYING FOR 2\*6 POS.

POS.	MATERIAL	COLOR	KEY	P/N
2*6	LEVEL A	DARK GREY	KEY A	5-2232266-4
		BROWN	KEY B	6-2232266-6
		GREEN	KEY C	7-2232266-6
		ORANGE	KEY D	8-2232266-6
2*5	LEVEL A	DARK GREY	KEY A	5-2232266-5
		BROWN	KEY B	6-2232266-5
		GREEN	KEY C	7-2232266-5
		ORANGE	KEY D	8-2232266-5

POS.	MATERIAL	COLOR	KEY	P/N
2*4	LEVEL A	DARK GREY	KEY A	5-2232266-4
		BROWN	KEY B	6-2232266-4
		GREEN	KEY C	7-2232266-4
		ORANGE	KEY D	8-2232266-4
2*3	LEVEL A	DARK GREY	KEY A	5-2232266-3
		BROWN	KEY B	6-2232266-3
		GREEN	KEY C	7-2232266-3
		ORANGE	KEY D	8-2232266-3
LEVEL B	BLACK	KEY A	1-2232266-1	1-2232266-1

THIS DRAWING IS A CONTROLLED DOCUMENT.

OWN: TOMMY\_WU 26MAR2013  
 CHK: TOMMY\_WU 26MAR2013  
 APVD: HAPYE\_WU 26MAR2013  
 YIYHONG\_MAO 26MAR2013

STE TE Connectivity

NAME: PLUG HOUSING, DOUBLE ROW POWER TRIPLE LOCK

PRODUCT SPEC: 108-106118  
 APPLICATION SPEC: 114-106118

SIZE: A1 CAGE CODE: 00779 DRAWING NO: 2232266  
 WEIGHT: -

Customer Drawing SCALE: - SHEET 2 OF 2 REV: C

RESTRICTED TO: -

单击下面可查看定价，库存，交付和生命周期等信息

[>>TE Connectivity\(泰科\)](#)