

THIS DRAWING IS UNPUBLISHED. RELEASED FOR PUBLICATION 2017
 © COPYRIGHT 2017 BY TE Connectivity ALL RIGHTS RESERVED.

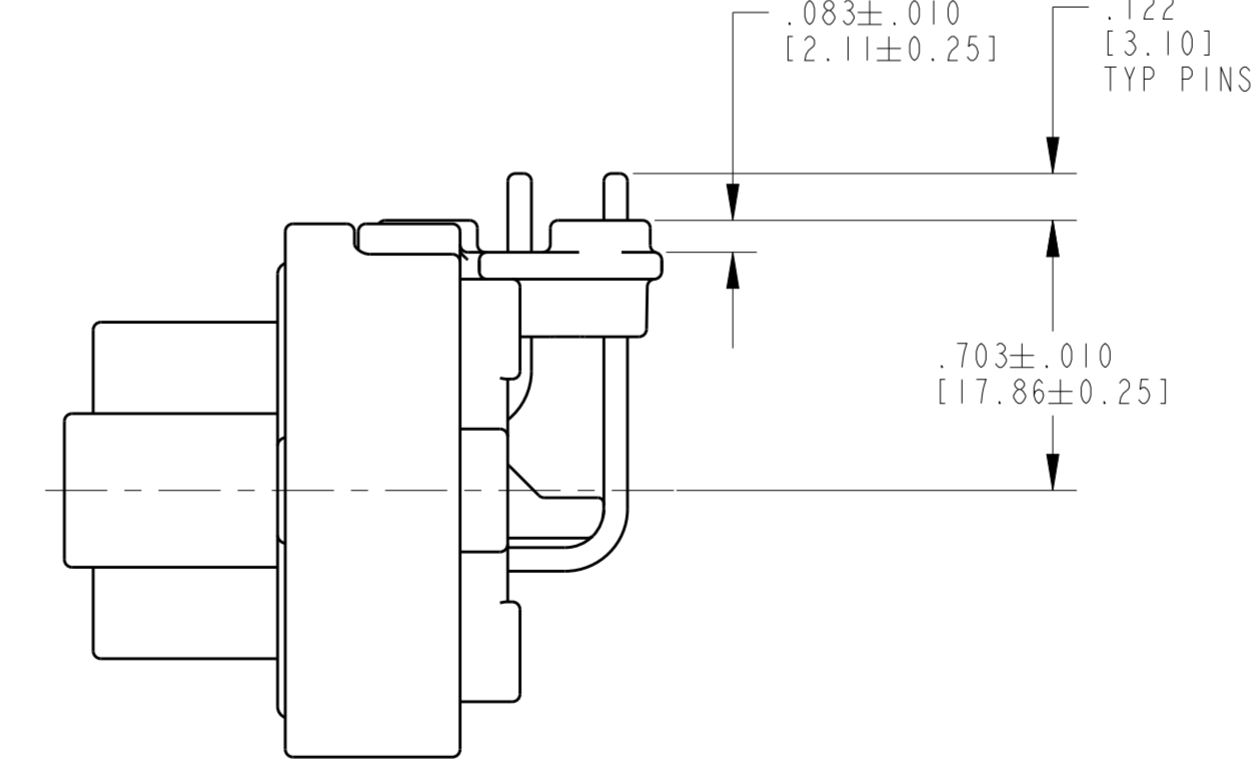

REVISIONS				
P	LTR	DESCRIPTION	DATE	APVD
C3		REVISED PER ECO-16-009536	24JUN2016	JA DM
C4		REVISED PER ECO-16-011652	05AUG2016	JA DM
D		REVISED PER PCN E-17-013520	18JUL2017	KM DM
D1		REVISED PER PCN E-20-011899	20AUG2020	DB IG

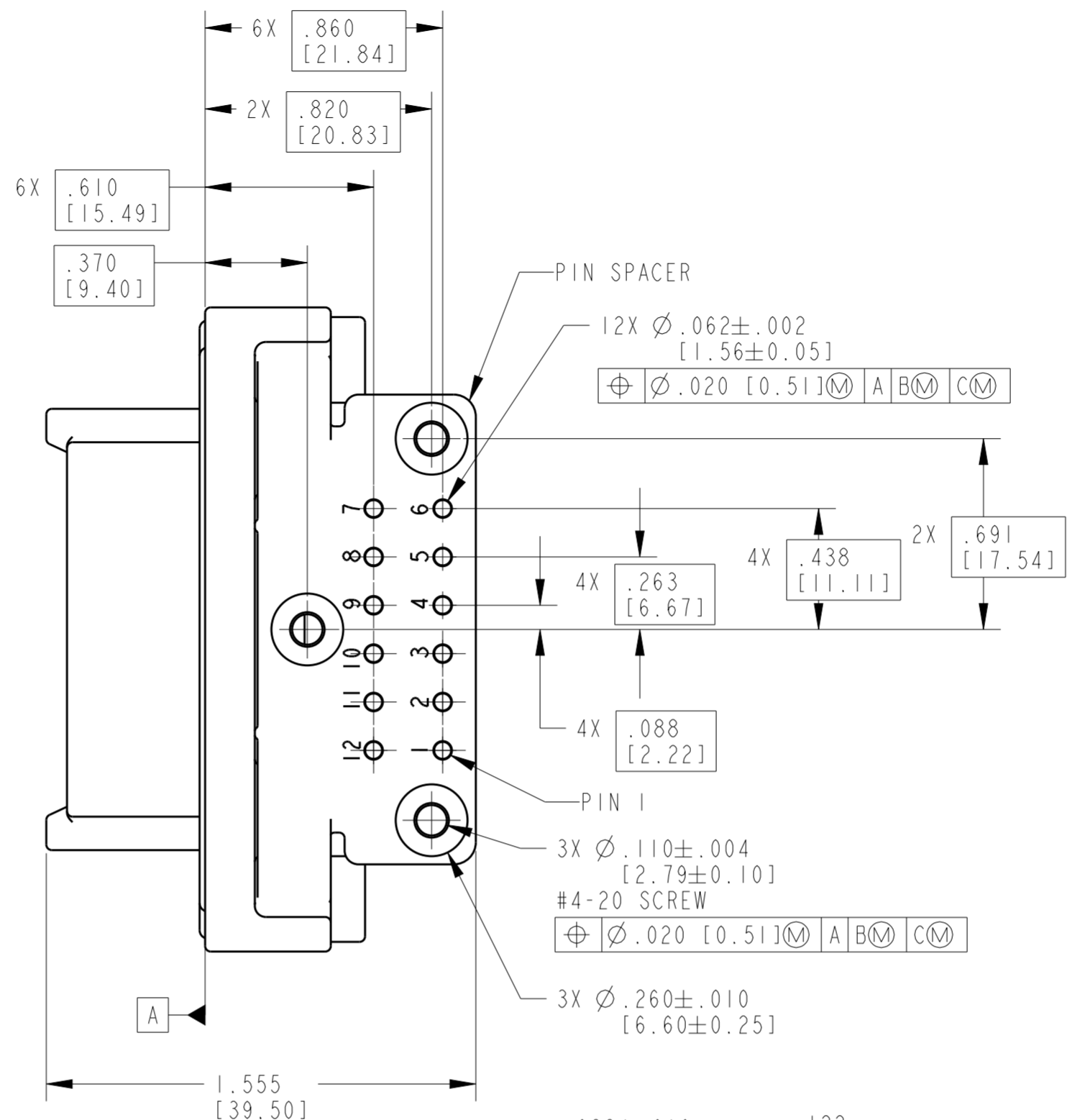
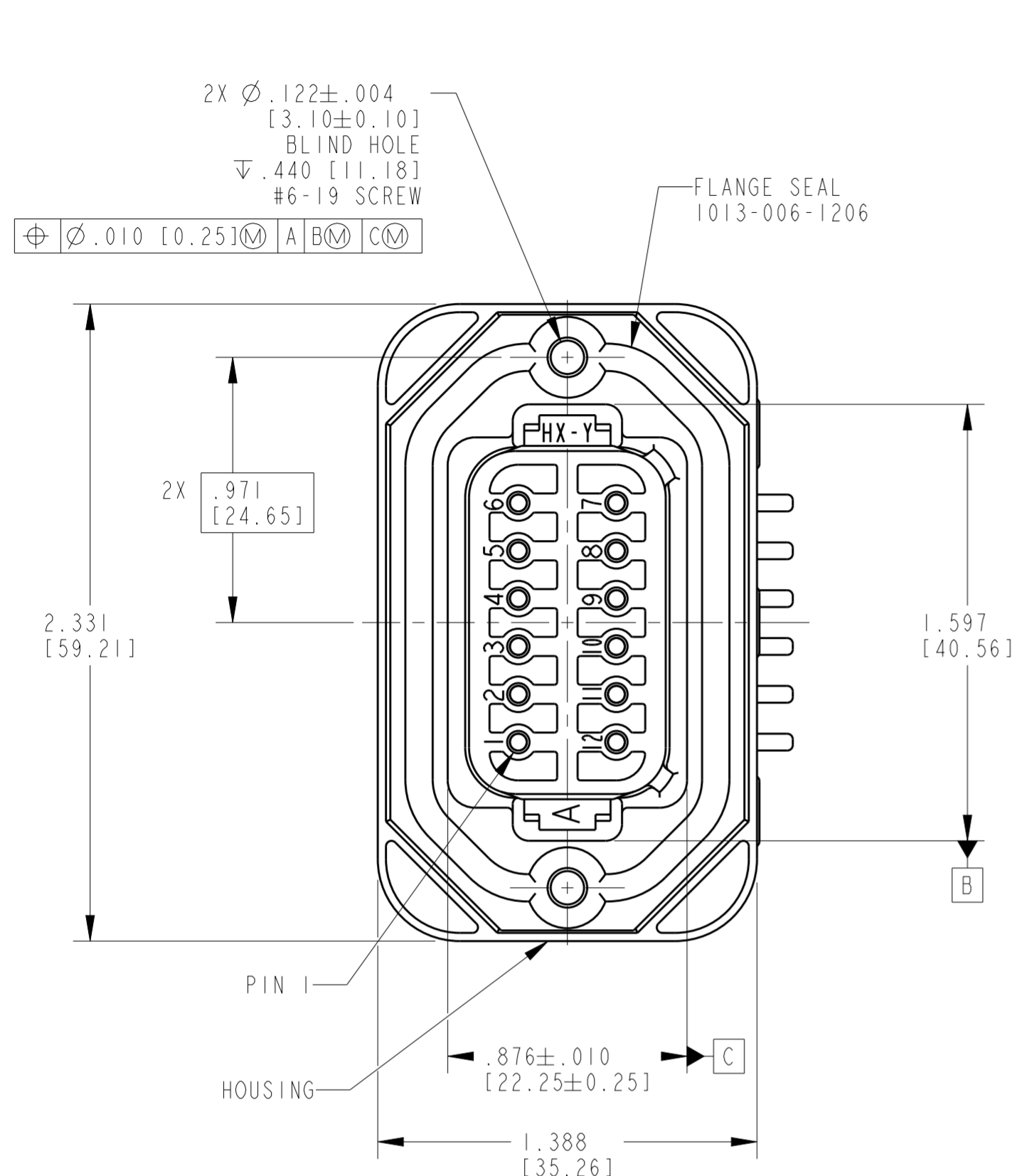
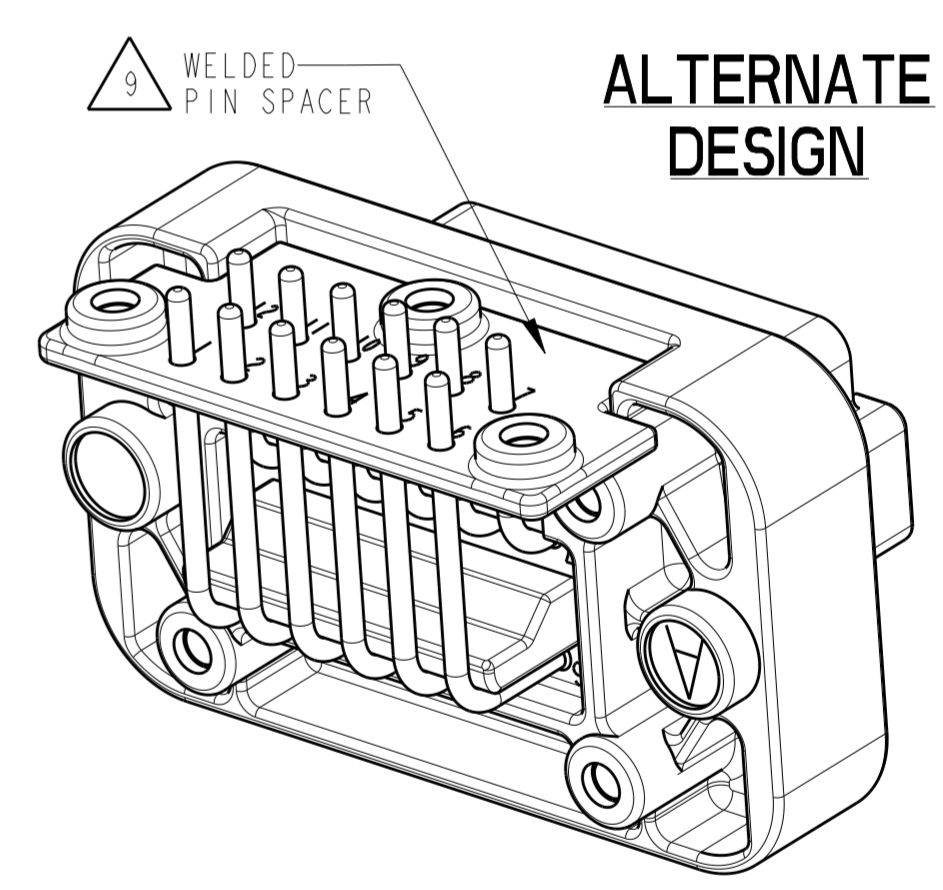
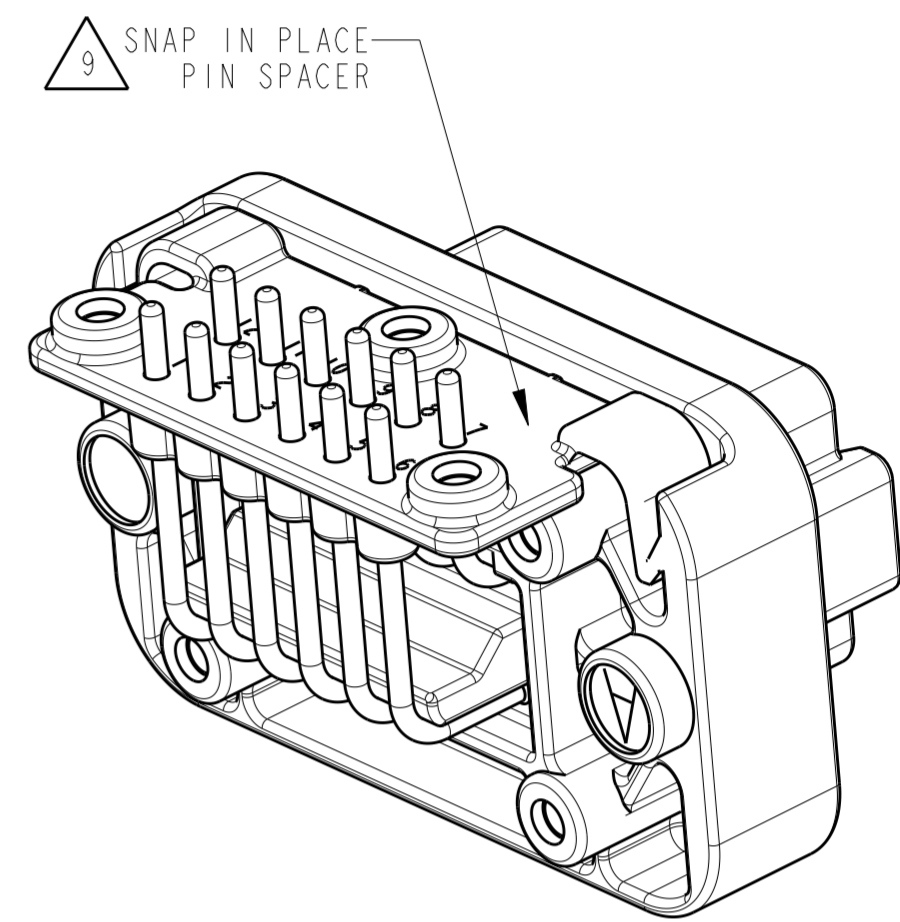

9. ALTERNATE PIN SPACER DESIGN RELATED TO MOLDING TOOL.

8. MOUNTING SURFACE SPECIFICATIONS:
 SURFACE FINISH: 32 µin [0.81 µm] Ra OR LESS
 FLATNESS: .005 in/in [0.13 mm/mm] MAX

7. SEE SHEET 2 FOR RECOMMENDED PANEL CUTOUTS.

6. SEE SHEET 3 FOR OTHER KEY ARRANGEMENTS.

5. MOUNTING SCREW TORQUE VALUES ARE AS FOLLOWS:
 #6-19 SCREWS: 11-13 in LB [1.24-1.46 N-m].
 #4-20 SCREWS: 4-9 in LB [.451-1.01 N-m].
 VALUES VALID FOR PLASTITE 48 SCREWS ONLY.

4. RECOMMENDED MOUNTING SCREWS (NOT INCLUDED): CAMCAR PLASTITE 48, SINGLE HELIX.

3. THIS RECEPTACLE MATES WITH DT06-12SX PLUG (X = A,B,C,D KEYS, XXXX = ALL MODIFICATIONS).

2. CONTACT PLATING - MATING SIDE: NICKEL; PCB SIDE: TIN

1. MATERIALS:
 HOUSING & PIN ALIGNMENT PLATE: PA46 GF30 (SEE SHEET 3 FOR COLORS)
 FLANGE SEAL: VMO (RED-ORANGE)
 PIN CONTACTS: COPPER ALLOY

NOTES:

TE INTERNAL PN	DEUTSCH PN
DT13-12PA	DT13-12PA
DT13-12PB	DT13-12PB
DT13-12PC	DT13-12PC
DT13-12PD	DT13-12PD

THIS DRAWING IS A CONTROLLED DOCUMENT.		DWN P. BURKE 06 JUN 2001	TE Connectivity			
DIMENSIONS: in [mm]		CHK K. MCKEE 03 JUL 2014				
TOLERANCES UNLESS OTHERWISE SPECIFIED:		APVD D. MEYER 03 JUL 2014				
0 PLC ± 1 PLC ± 2 PLC ± 3 PLC ±.025 [0.64] 4 PLC ± ANGLES ±0°30'0" FINISH -		NAME RECEPTACLE HEADER 12 PIN, 90 DEG DT SERIES				
MATERIAL		PRODUCT SPEC 108-151009	SIZE A2	CAGE CODE 4AFU8	DRAWING NO DT13-12PX	RESTRICTED TO
CUSTOMER DRAWING		WEIGHT 59.8 (g)	SCALE 2:1	SHEET 1	OF 3	REV D1

4

3

2

1

THIS DRAWING IS UNPUBLISHED. RELEASED FOR PUBLICATION 2017
 © COPYRIGHT 2017 BY TE Connectivity ALL RIGHTS RESERVED.

REVISIONS				
P	LTR	DESCRIPTION	DATE	APVD
ev_sym_1	16E6-8H6E11		rev.date	ev_dwn_1
ev_sym_2	rev_desc_2		rev.date	ev_dwn_2
ev_sym_3	rev_desc_3		rev.date	ev_dwn_3
ev_sym_4	rev_desc_4		rev.date	ev_dwn_4

7 DIGIT DATECODE
 YEAR: FIRST AND SECOND DIGITS. (16 = 2016)
 MONTH: THRID DIGIT, EXCLUDING 1. A = JAN.,
 B = FEB., C = MARCH... (L = NOVEMBER)
 DAY: FOURTH AND FIFTH DIGITS (10 = 10th DAY)
 HOUR: SIXTH AND SEVENTH DIGITS (14 = 2-3PM)

3D VIEW

8 RECOMMENDED PANEL CUTOUTS

THIS DRAWING IS A CONTROLLED DOCUMENT.		DWN P. BURKE 06 JUN 2001	TE Connectivity	
DIMENSIONS: in [mm]		CHK K. MCKEE 03 JUL 2014		
TOLERANCES UNLESS OTHERWISE SPECIFIED:		APVD D. MEYER 03 JUL 2014	NAME RECEPTACLE HEADER 12 PIN, 90 DEG DT SERIES	
0 PLC ± 1 PLC ± 2 PLC ± 3 PLC ±.025 [0.64] 4 PLC ±		PRODUCT SPEC 108-151009	SIZE A2	CAGE CODE 4AFU8
MATERIAL 1		APPLICATION SPEC -	DRAWING NO C-DT13-12PX	RESTRICTED TO -
ANGLES FINISH		WEIGHT 59.8 (g)	SCALE 2:1	SHEET 2 OF 3
		CUSTOMER DRAWING	REV D1	

1471-9 (3/13)

Downloaded From Onezac.com

REVISIONS				
P	LTR	DESCRIPTION	DATE	DWN APVD
ev_sym_1	16EW-8HBEI11		rev.date	ev_sym_1_dwnv_lappr_1
ev_sym_2	rev_desc_2		rev.date	ev_sym_2_dwnv_2appr_2
ev_sym_3	rev_desc_3		rev.date	ev_sym_3_dwnv_3appr_3
ev_sym_4	rev_desc_4		rev.date	ev_sym_4_dwnv_4appr_4

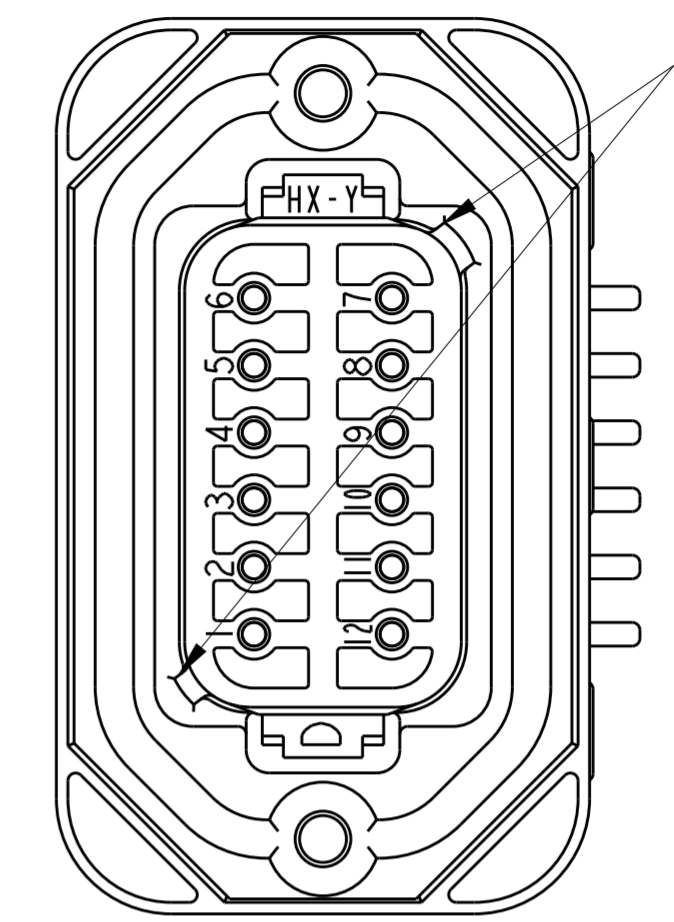
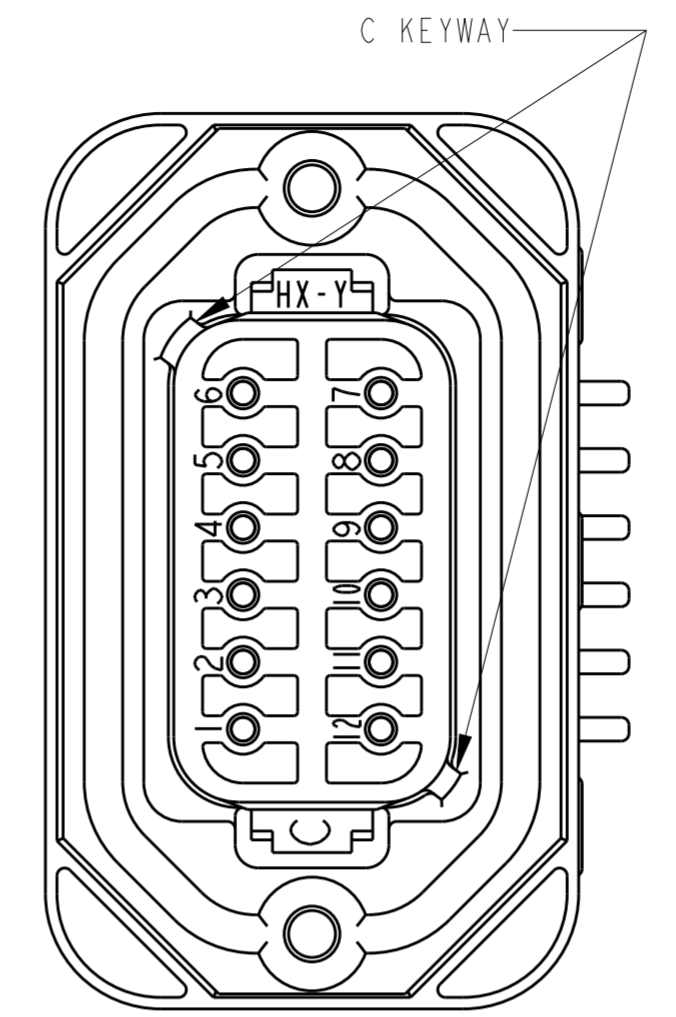
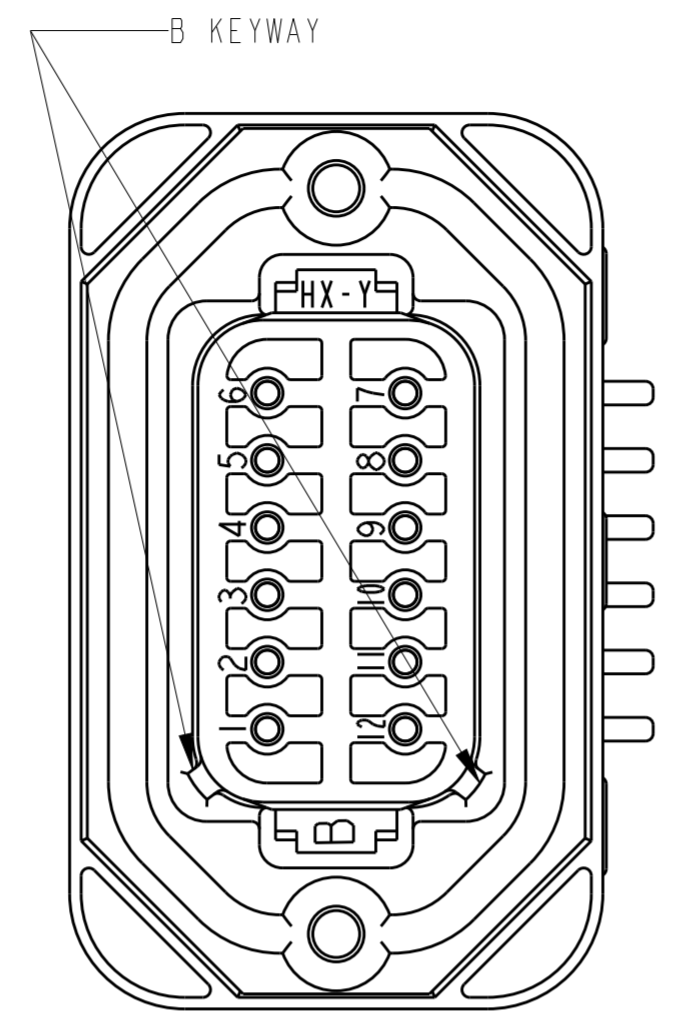
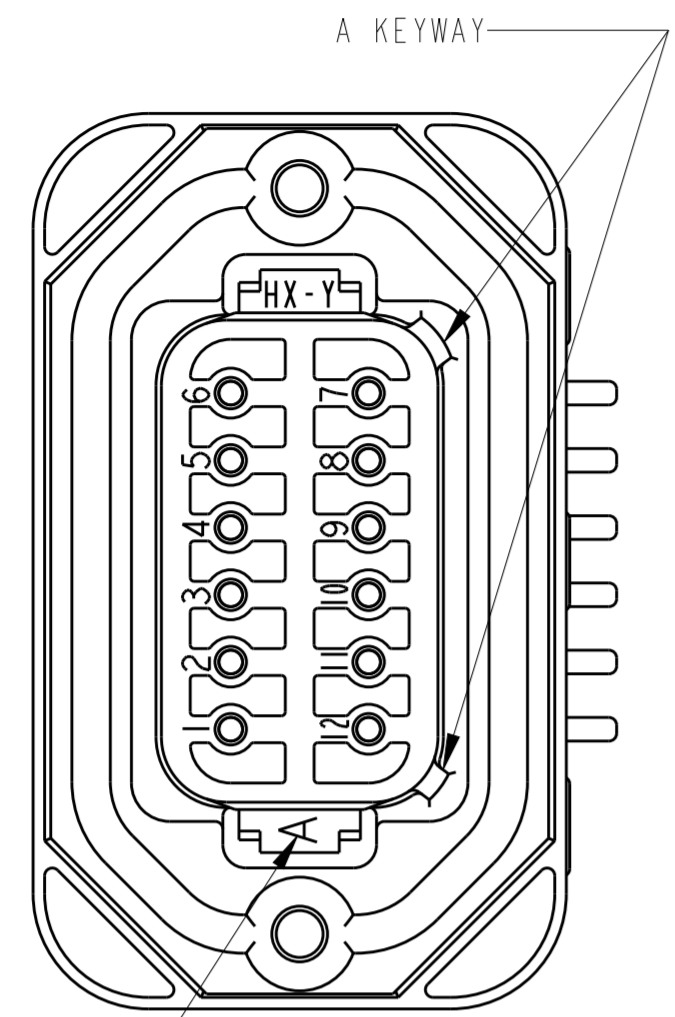

KEYING ARRANGEMENT INDICATOR, TYP

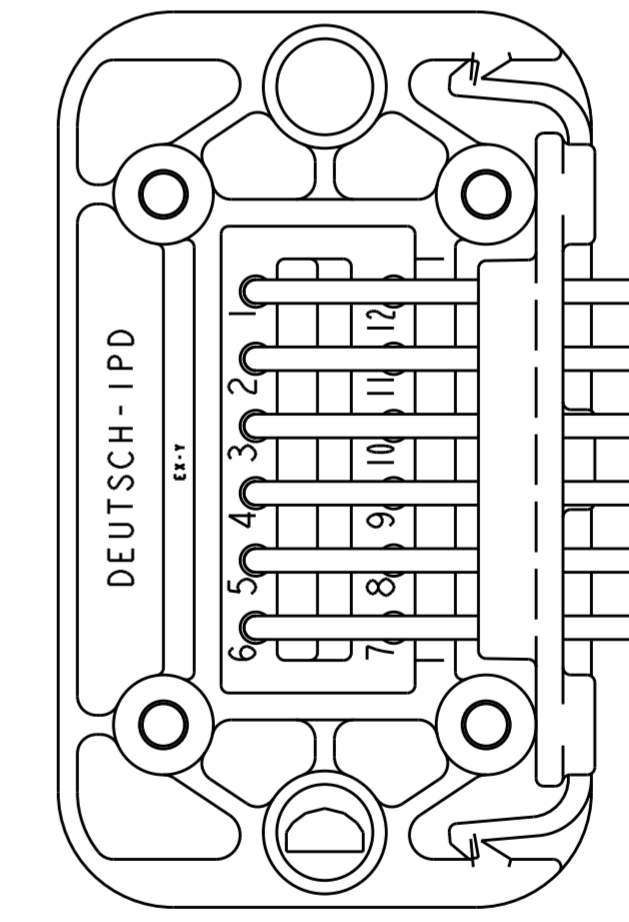
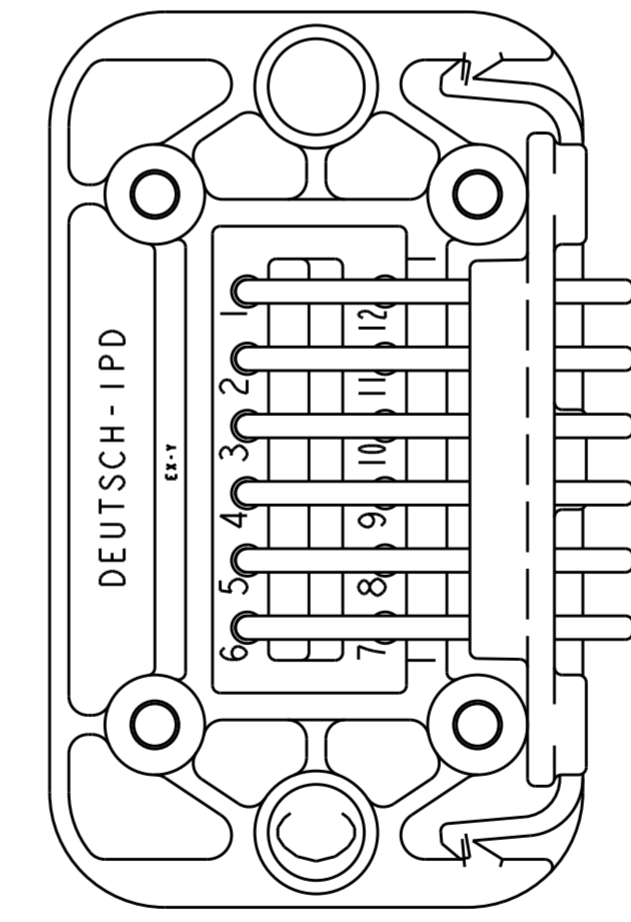
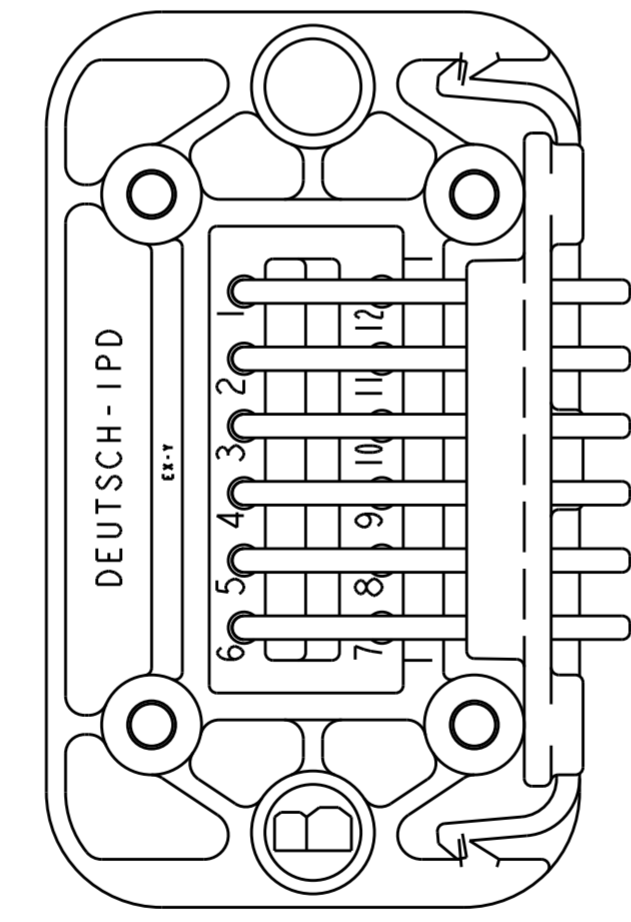
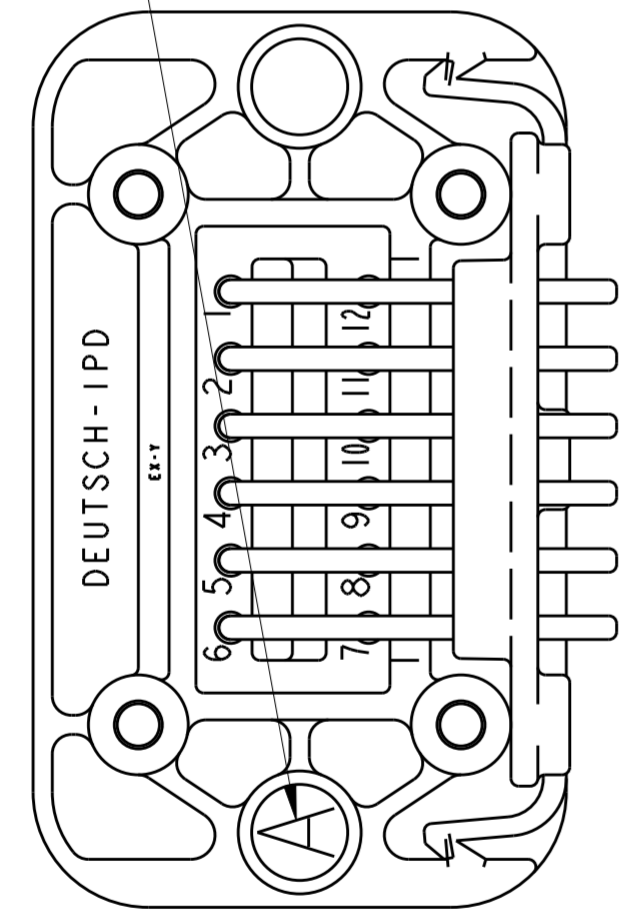

DT13-12PA
COLOR GREY

DT13-12PB
COLOR BLACK

DT13-12PC
COLOR GREEN

DT13-12PD
COLOR BROWN

THIS DRAWING IS A CONTROLLED DOCUMENT.		DWN P. BURKE 06 JUN 2001	 TE Connectivity
DIMENSIONS: in [mm]		CHK K. MCKEE 03 JUL 2014	
TOLERANCES UNLESS OTHERWISE SPECIFIED:		APVD D. MEYER 03 JUL 2014	
0 PLC ± 1 PLC ± 2 PLC ± 3 PLC ±.025 [0.64] 4 PLC ± ANGLES ±0°30'0" FINISH -		PRODUCT SPEC 108-151009 APPLICATION SPEC -	
MATERIAL		WEIGHT 59.8 (g)	NAME RECEPTACLE HEADER 12 PIN, 90 DEG DT SERIES SIZE CAGE CODE DRAWING NO A2 4AFU8 C-DT13-12PX RESTRICTED TO -
CUSTOMER DRAWING		SCALE 2:1	SHEET 3 OF 3 REV D1

单击下面可查看定价，库存，交付和生命周期等信息

[>>TE Connectivity\(泰科\)](#)