

TYCO ELECTRONICS RESERVES THE RIGHT TO AMEND THIS DRAWING AT ANY TIME. USERS SHOULD EVALUATE THE SUITABILITY OF THE PRODUCT FOR THEIR APPLICATION.

REVISIONS			
LTR	DESCRIPTION	DATE	APPROVED
A	INITIAL RELEASE PER DCR R060291	5/5/06	LRODRIGUEZ

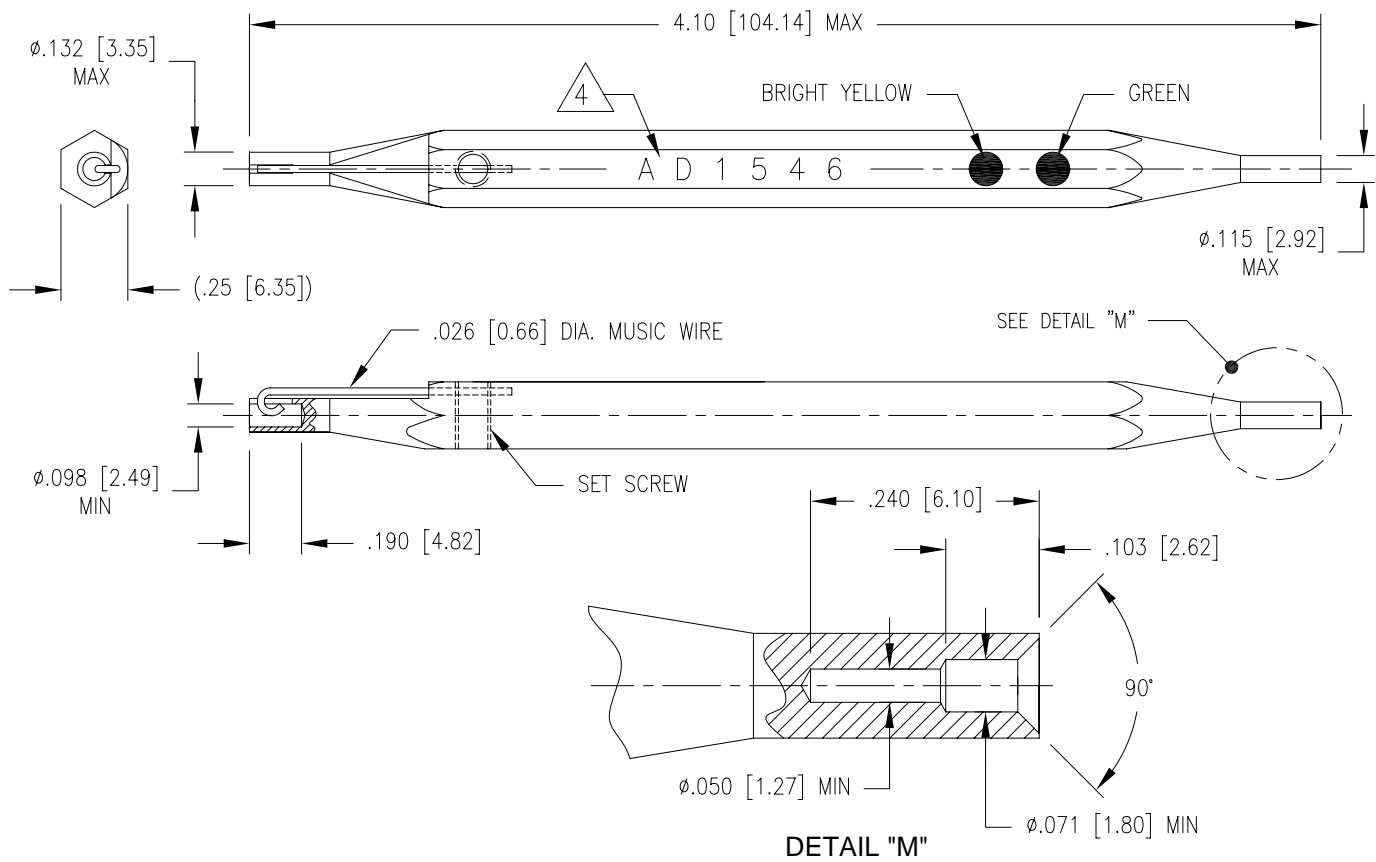

NOTES:

1. THIS PRODUCT IS DESIGNED FOR USE WITH D-141-0113 AND D-141-0114 RAYCHEM TERMAPOST SOLDERSLIEVES TO TERMINATE STRANDED CONDUCTORS TO WIRE WRAP POSTS.
2. MATERIAL: 6061-T6 ALUMINUM.
3. FINISH: GOLD ANODIZED PER MIL-A-8625F, TYPE III, CLASS Z.
4. MODEL NO. TO BE STAMPED OR ENGRAVED APPROXIMATELY LOCATED AS SHOWN.

If this document is printed it becomes uncontrolled. Check for the latest revision

©2006 Tyco Electronics Corporation. All rights reserved.

SPECIFICATION CONTROL DRAWING

UNLESS OTHERWISE SPECIFIED DIMENSIONS ARE IN INCHES. METRIC DIMENSIONS ARE IN BRACKETS. DECIMALS .XXX ± 0.005 [0.13 mm] .XX ± 0.01 [0.25 mm] .X ± 0.1 [0.50 mm] ANGLES .X ± 0.5 DEG	DRAWN MFORONDA 4/27/06		Tyco Electronics Corporation 300 Constitution Drive Menlo Park, CA. 94025 U.S.A.		
	CHECKED --- ---				TITLE INSTALLATION TOOL FOR D-141-0113 AND D-141-0114 SOLDERSLIEVES
	APPROVED --- ---	CAD NAME: R060291.dwg	SIZE A	CODE IDENT. NO. 06090	DWG. NO. AD-1546
	THIRDS ANGLE PROJECTION 	DO NOT SCALE THIS DRAWING	SHEET 1 OF 1		

单击下面可查看定价，库存，交付和生命周期等信息

[>>TE Connectivity\(泰科\)](#)