

THIS DRAWING IS UNPUBLISHED. RELEASED FOR PUBLICATION ,19 .
 © COPYRIGHT 19 BY AMP INCORPORATED. ALL RIGHTS RESERVED.

LOC		DIST		REVISIONS			
P	LTR	DESCRIPTION	DATE	DWN	APVD		
G	14	G	REDRAWN PER 0720-0377-94	10OCT94	LO	ME	

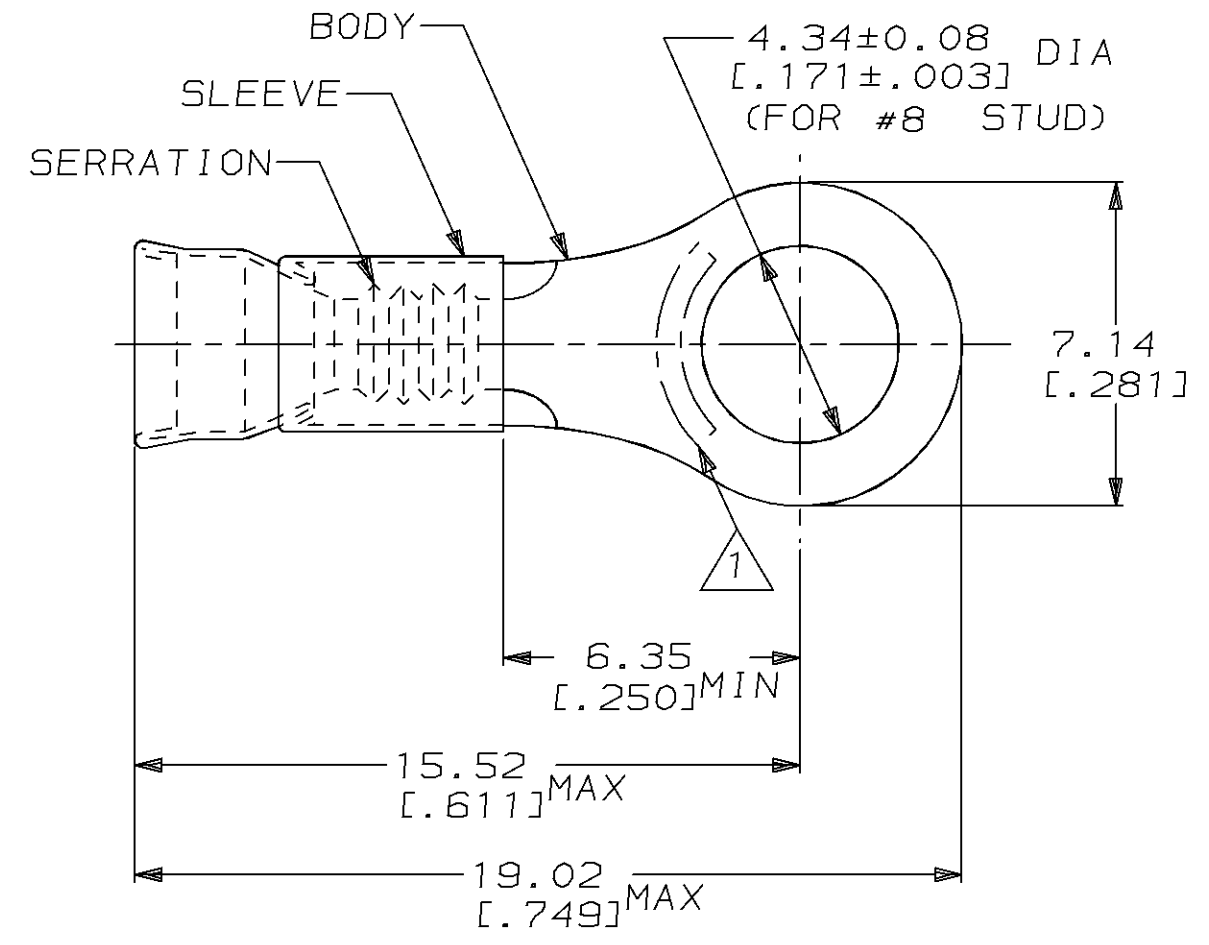

- 1. STAMP AMP 22-18*APPROX AS SHOWN
 22-16 TERMINALS ARE STAMPED 22-18 IN
 ACCORDANCE WITH MILITARY SPEC MIL-T-7928
 COMMERCIAL WIRE RANGE IS 22-16
- 2. WIRE INSUL DIA, 2.67-3.56 [.105-.140]
- 3. TONGUE MATL THK, 0.79±0.05 [.031±.002]

1000	LOOSE PIECE	322365
QTY	PACKAGE TYPE	PART NO

AMP INCORPORATED CUSTOMER SERVICE SYSTEM		MAX RECOMMENDED OPERATING TEMPERATURE: 343°C [650°F]	THIS DRAWING IS A CONTROLLED DOCUMENT FOR AMP INCORPORATED. IT IS SUBJECT TO CHANGE AND THE CONTROLLING ENGINEERING ORGANIZATION SHOULD BE CONTACTED FOR THE LATEST REVISION.		DWN L OLMEDA 10OCT94	AMP Incorporated Harrisburg, PA 17105-3608
FOR ADDITIONAL PRODUCT INFORMATION OR COPIES OF DRAWINGS AND TECHNICAL DOCUMENTS	PRODUCT INFORMATION CENTER 1-800-522-6752		DIMENSIONS: mm [in]	TOLERANCES UNLESS OTHERWISE SPECIFIED:	CHK M ELLIS 10OCT94	
FOR APPLICATION TOOLING INFORMATION	TOOLING ASSISTANCE CENTER 1-800-722-1111	VOLTAGE RATING: -	0 PLC ±- 1 PLC ±- 2 PLC ±0.20 [.008] 3 PLC ±- 4 PLC ±- ANGLES ±-	APVD -	PRODUCT SPEC -	TERMINAL, RING TONGUE, STRATOTHERM, DIAMOND GRIP, WIRE SIZE, 22-16 AWG
FOR ORDER ENTRY	1-800-526-5142	CIRCULAR MIL AREA: 0.26mm²-1.65mm² [509-3260]	MATERIAL BODY, CU PER ASTM B152 SLEEVE, NI SIL PER ASTM B122	FINISH BODY, NP, QQ-N-290	APPLICATION SPEC -	SIZE A3
		STRANDED WIRE	CUSTOMER DRAWING		WEIGHT -	CAGE CODE 00779
						DRAWING NO G-322365
						SCALE 6:1
						SHEET 1 OF 1
						REV G

单击下面可查看定价，库存，交付和生命周期等信息

[>>TE Connectivity\(泰科\)](#)