

THIS DRAWING IS UNPUBLISHED. RELEASED FOR PUBLICATION 20
 © COPYRIGHT 20 BY - ALL RIGHTS RESERVED.

LOC	DIST	REVISIONS					
		P	LTR	DESCRIPTION	DATE	DWN	APVD
ES	00	A6	ECR-15-016520		25NOV2015	SL	RR
		A7	ECR-17-001536		03FEB2017	IZ	RR
		A8	ECR-18-008584		05JUN2018	BW	LZ
		A9	ECR-18-009485		19MAY2019	BW	WW

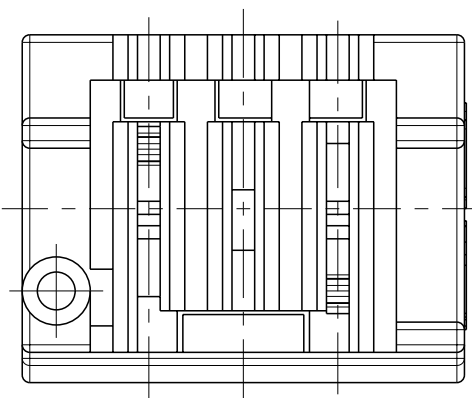
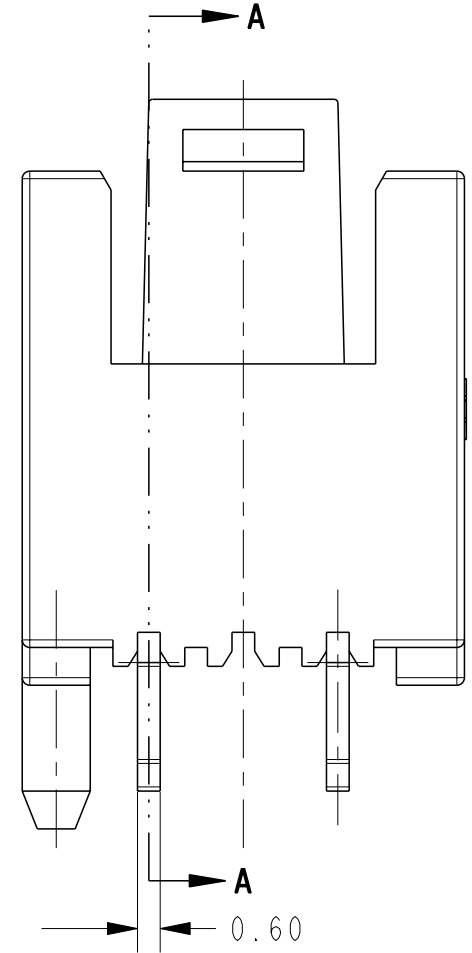
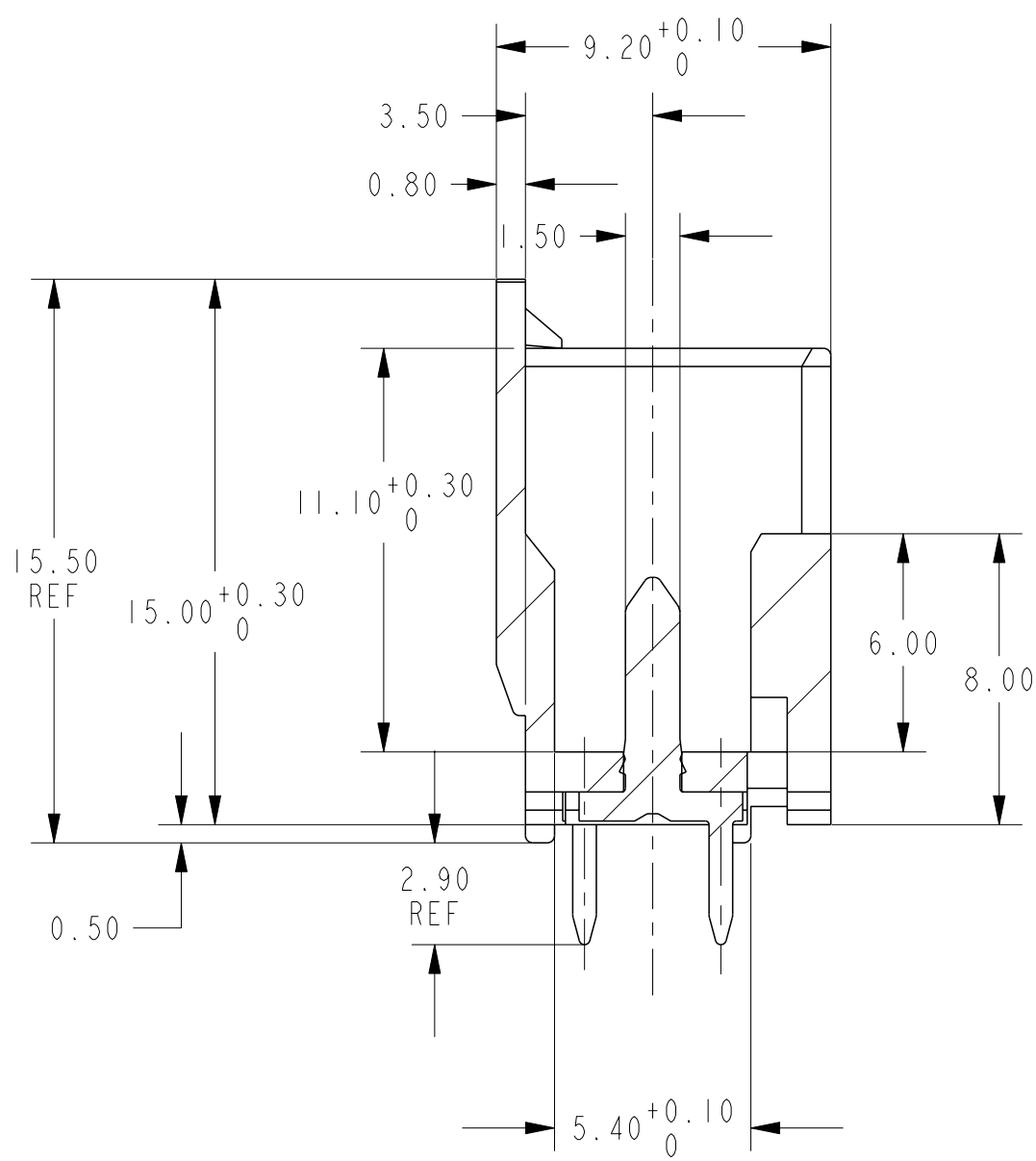
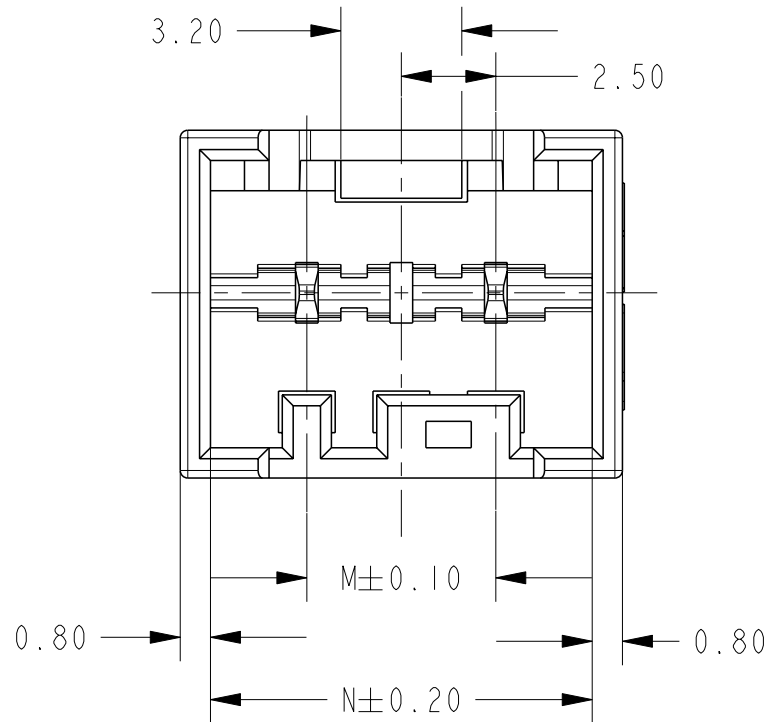

NOTE

- SEE SHEET 2 FOR AVAILABLE CONFIGURATIONS
- MATERIAL: HOUSING, NYLON, UL94 V0, 750°C GWT NO FLAME
EIGHT COLORS AVAILABLE, INCLUDING: NATURAL, RED, BLUE, YELLOW, BLACK, GREY, GREEN, PURPLE
WHITE VERSION IS PRELIMINARY

CONTACT, COPPER ALLOY, 0.60MM THICK
- FINISH: OPTION 1: TIN PLATING OVER NICKEL UNDERPLATING
OPTION 2: AG PLATING OVER NICKEL UNDERPLATING
- PCB LAYOUT AS SHOWN
- △ THE PART NUMBERS SHOWING IN SHEET 2 & 3 ARE FOR NATURAL COLOR. THE PART NUMBER FOR OTHER COLOR ARE BASED ON THE NATURAL ONE: FOR THE SAME CONFIGURATION, THE PREFIX AND POSTFIX OF THE P/N ARE THE SAME, ONLY THE BASE NUMBER IS DIFFERENT ACCORDING TO DIFFERENT COLOR, DETAIL PLEASE SEE SHEET 4
- PACKAGING: LOOSE PIECE OR TUBE. THE PART NUMBERS IN THIS DRAWING ARE WITH LOOSE PIECE PACKAGING. PLEASE CONTACT TE SALES REPRESENTATIVES FOR TUBE PACKAGING REQUIREMENT.
- △ PRELIMINARY PART NOT RELEASED FOR PRODUCTION

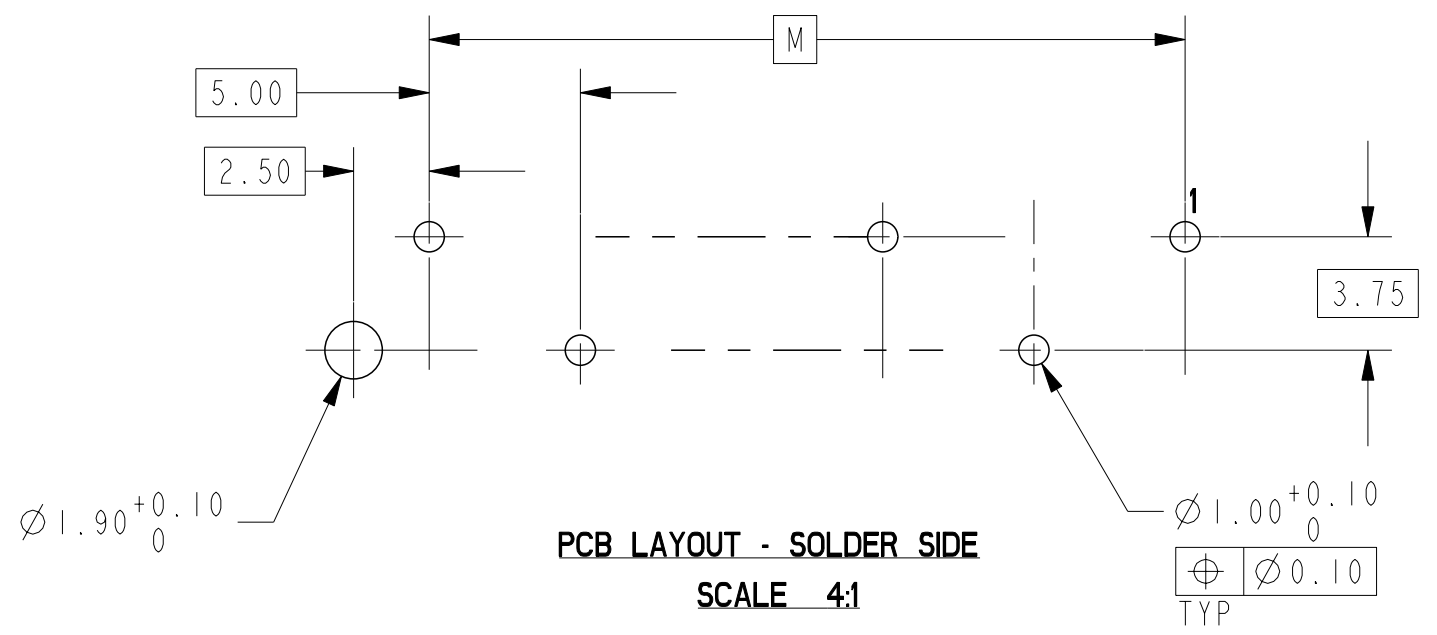

N	M	NO. OF POS.
40.10	35.00	8 LOAD, 15 POS.
35.10	30.00	7 LOAD, 13 POS.
30.10	25.00	6 LOAD, 11 POS.
25.10	20.00	5 LOAD, 9 POS.
20.10	15.00	4 LOAD, 7 POS.
15.10	10.00	3 LOAD, 5 POS.
10.10	5.00	2 LOAD, 3 POS.

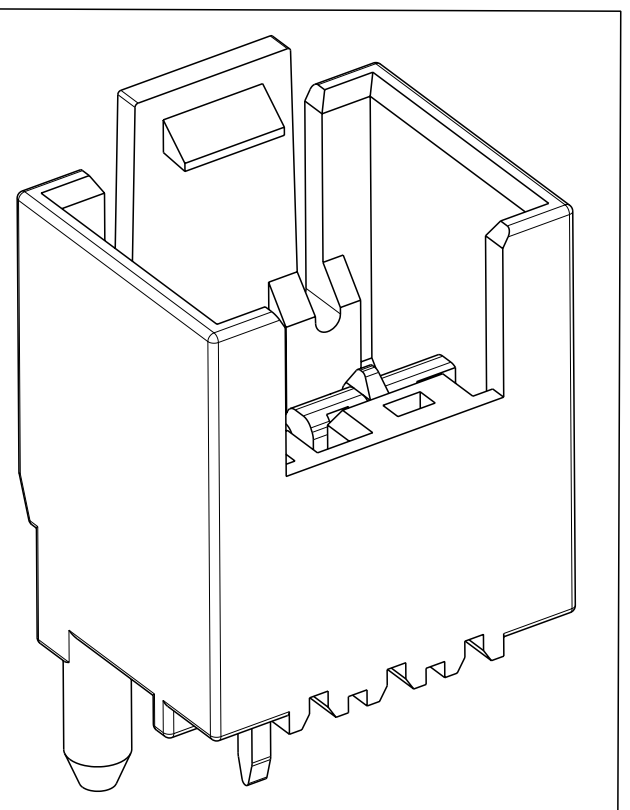

THIS DRAWING IS A CONTROLLED DOCUMENT.

DIMENSIONS: mm	TOLERANCES UNLESS OTHERWISE SPECIFIED: 0 PLC ± 1 PLC ± 2 PLC ±0.20 3 PLC ± 4 PLC ± ANGLES ±° FINISH	DWN WINTER WANG 12NOV2012 CHK HAPYE WU 12NOV2012 APVD YUHONG MAO 12NOV2012 PRODUCT SPEC 108-106079 APPLICATION SPEC - WEIGHT - CUSTOMER DRAWING	NAME RAST 2.5 TAB HEADER ASSY, SELECTIVE LOADED, TH, VERTICAL, EXTERNAL LOCKING SIZE A2 CAGE CODE 00779 DRAWING NO. C-1971921 RESTRICTED TO - SCALE NTS SHEET 1 OF 5 REV A9
----------------	--	---	--

TE Connectivity

THIS DRAWING IS UNPUBLISHED. RELEASED FOR PUBLICATION 20
 © COPYRIGHT 20 BY - ALL RIGHTS RESERVED.

LOC	DIST	REVISIONS					
ES	00	P	LTR	DESCRIPTION	DATE	DWN	APVD
		-		SEE SHEET 1	-	-	-

QTY	TAB CONTACT	QTY	HOUSING	POS.	TE PART NO.	
8	TAB CONTACT w/ SILVER PLATING	1	RAST 2.5 TAB HEADER HOUSING, EXTERNAL LOCKING, 15P (SEE THE DETAIL LAYOUT ON SHEET 3)	15	3-1971924-5 2-1971924-5 1-1971924-5	
7		1		13	1-1971924-3	
6		1		11	2-1971924-1 1-1971924-1	
5		1	RAST 2.5 TAB HEADER HOUSING, EXTERNAL LOCKING, 9P (SEE THE DETAIL LAYOUT ON SHEET 3)	9	6-1971923-9 5-1971923-9 4-1971923-9 3-1971923-9 2-1971923-9 1-1971923-9	
4		1		RAST 2.5 TAB HEADER HOUSING, EXTERNAL LOCKING, 7P (SEE THE DETAIL LAYOUT ON SHEET 3)	7	8-1971923-7 7-1971923-7 6-1971923-7 5-1971923-7 4-1971923-7 3-1971923-7 2-1971923-7 1-1971923-7
3		1			5	6-1971923-5 5-1971923-5 4-1971923-5 3-1971923-5 2-1971923-5 1-1971923-5
2		1			RAST 2.5 TAB HEADER HOUSING, EXTERNAL LOCKING, 3P (SEE THE DETAIL LAYOUT ON SHEET 3)	3

QTY	TAB CONTACT	QTY	HOUSING	POS.	TE PART NO.	
8	TAB CONTACT w/ TIN PLATING	1	RAST 2.5 TAB HEADER HOUSING, EXTERNAL LOCKING, 15P (SEE THE DETAIL LAYOUT ON SHEET 3)	15	3-1971922-5 2-1971922-5 1-1971922-5	
7		1		13	1-1971922-3	
6		1		11	2-1971922-1 1-1971922-1	
5		1	RAST 2.5 TAB HEADER HOUSING, EXTERNAL LOCKING, 9P (SEE THE DETAIL LAYOUT ON SHEET 3)	9	6-1971921-9 5-1971921-9 4-1971921-9 3-1971921-9 2-1971921-9 1-1971921-9	
4		1		RAST 2.5 TAB HEADER HOUSING, EXTERNAL LOCKING, 7P (SEE THE DETAIL LAYOUT ON SHEET 3)	7	8-1971921-7 7-1971921-7 6-1971921-7 5-1971921-7 4-1971921-7 3-1971921-7 2-1971921-7 1-1971921-7
3		1			5	9-1971921-5 8-1971921-5 7-1971921-5 6-1971921-5 5-1971921-5 4-1971921-5 3-1971921-5 2-1971921-5 1-1971921-5
2		1			RAST 2.5 TAB HEADER HOUSING, EXTERNAL LOCKING, 3P (SEE THE DETAIL LAYOUT ON SHEET 3)	3

THIS DRAWING IS A CONTROLLED DOCUMENT. 29MAY2012
 DWN BOB YANG 12NOV2012
 CHK HAPYE WU 12NOV2012
 APVD YUHHONG MAO 12NOV2012

STE TE Connectivity

DIMENSIONS: mm TOLERANCES UNLESS OTHERWISE SPECIFIED:
 0 PLC ±
 1 PLC ±
 2 PLC ±0.20
 3 PLC ±
 4 PLC ±
 ANGLES ±°
 FINISH

MATERIAL -

PRODUCT SPEC -
 APPLICATION SPEC -
 WEIGHT -

NAME RAST 2.5 TAB HEADER ASSY,
 SELECTIVE LOADED, TH, VERTICAL,
 EXTERNAL LOCKING

SIZE A2 CAGE CODE 00779 DRAWING NO. C-1971921 RESTRICTED TO -
 CUSTOMER DRAWING SCALE NTS SHEET 2 OF 5 REV A9

LOC	DIST	REVISIONS					
		P	LYR	DESCRIPTION	DATE	OWN	APVD
-	-	-	-	SEE SHEET 1	-	-	-



1-1971921-3 5-1971921-3
 1-1971923-3 5-1971923-3



2-1971921-3 6-1971921-3
 2-1971923-3 6-1971923-3

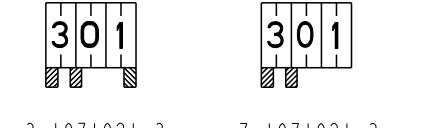

3-1971921-3 7-1971921-3
 3-1971923-3 7-1971923-3

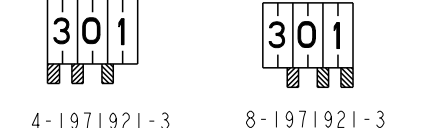

4-1971921-3 8-1971921-3
 4-1971923-3 8-1971923-3

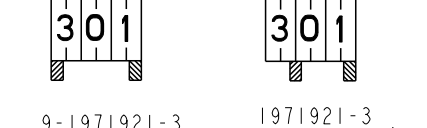

9-1971921-3 1971921-3
 9-1971921-3 1971921-3

3 POS



1-1971921-5 8-1971921-5
 1-1971923-5 8-1971923-5



2-1971921-5 9-1971921-5
 2-1971923-5 9-1971923-5

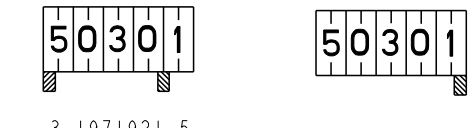

3-1971921-5 6-1971921-5
 3-1971923-5 6-1971923-5

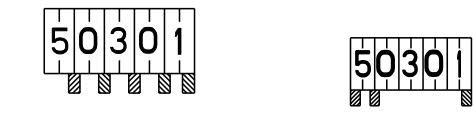

4-1971921-5 7-1971921-5
 4-1971923-5 7-1971921-5

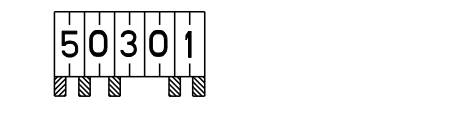

5-1971921-5 5-1971923-5

5 POS

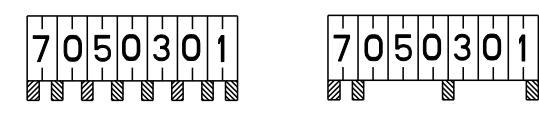

1-1971921-7 5-1971921-7
 1-1971923-7 5-1971923-7

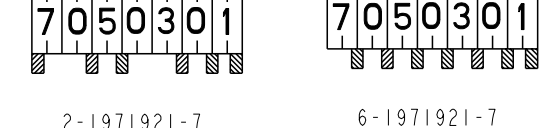

2-1971921-7 6-1971921-7
 2-1971923-7 6-1971923-7

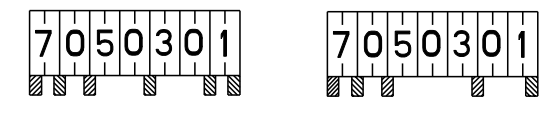

3-1971921-7 7-1971921-7
 3-1971923-7 7-1971923-7

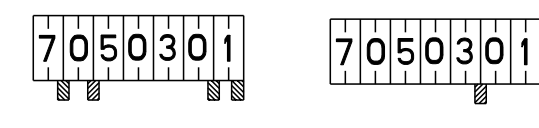

4-1971921-7 8-1971921-7
 4-1971923-7 8-1971923-7

7 POS

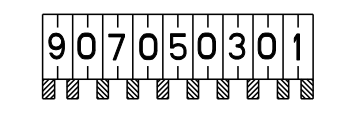

1-1971921-9 1-1971923-9

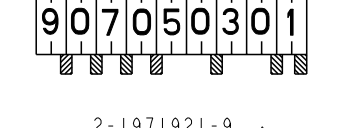

2-1971921-9 5-1971921-9
 2-1971923-9 5-1971923-9

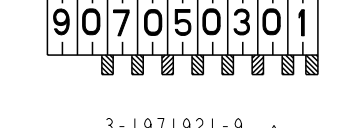

3-1971921-9 6-1971921-9
 3-1971923-9 6-1971923-9

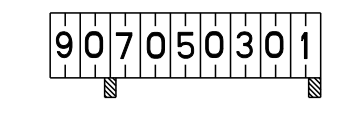

4-1971921-9 4-1971923-9

9 POS

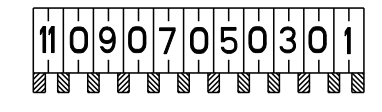

1-1971922-1 1-1971924-1

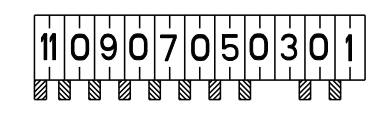

2-1971922-1 2-1971924-1

11 POS

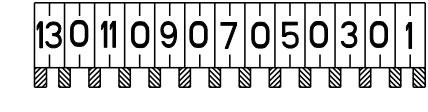

1-1971922-3 1-1971924-3

13 POS

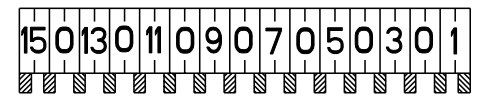

1-1971922-5 1-1971924-5

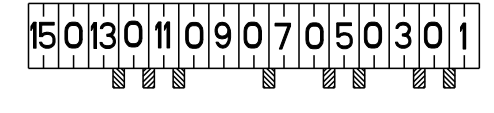

2-1971922-5 2-1971924-5

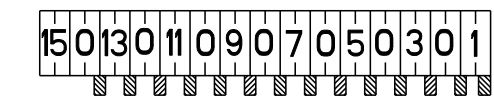

3-1971922-5 3-1971924-5

15 POS

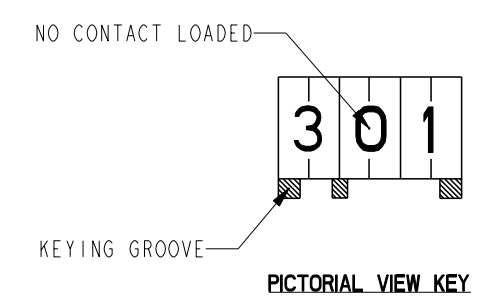

THIS DRAWING IS A CONTROLLED DOCUMENT.		OWN: BOB YANG 12NOV2012	TE Connectivity
DIMENSIONS: mm		CHK: HAPYE WU 12NOV2012	
TOLERANCES UNLESS OTHERWISE SPECIFIED:		APVD: YUHONG MAO 12NOV2012	NAME: RAST 2.5 TAB HEADER ASSY
0 PLC ±		PRODUCT SPEC	SELECTIVE LOADED, TH, VERTICAL, EXTERNAL LOCKING
1 PLC ±		APPLICATION SPEC	
2 PLC ±0.20		SIZE: A1	CAGE CODE: 00779
3 PLC ±		DRAWING NO: C=1971921	RESTRICTED TO: -
4 PLC ±		WEIGHT: -	SCALE: NTS
ANGLES ±°		CUSTOMER DRAWING	SHEET 3 OF 5
FINISH: -			REV A9

LOC	DIST	REVISIONS					
		P	LYR	DESCRIPTION	DATE	OWN	APVD
-	-	-	-	SEE SHEET 1	-	-	-

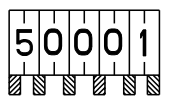

1-2825332-5

5 POS

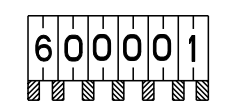

1-2825332-6

6 POS

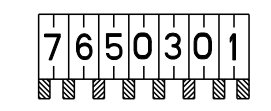

1-2825332-7

7 POS

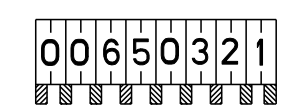

1-2825332-8

8 POS

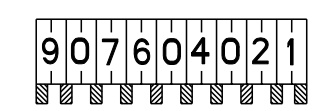

1-2825332-9

9 POS

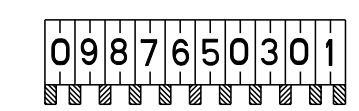

1-2825332-0

10 POS

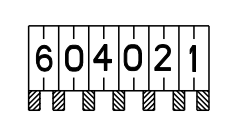

2-2825332-6

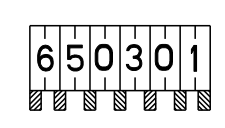

3-2825332-6

6 POS

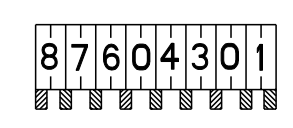

2-2825332-8

8 POS

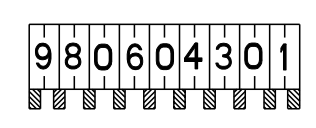

2-2825332-9

9 POS

PRELIMINARY PART - NOT RELEASED FOR PRODUCTION
 PART NUMBERS X-2825332-X ARE EQUIVALENT TO #-1971921-# IN GEOMETRY AND MATERIAL,
 WITH ADDITIONAL POSITIONS, CONTACT LOADING AND POLARIZATIONS, AS SHOWN.

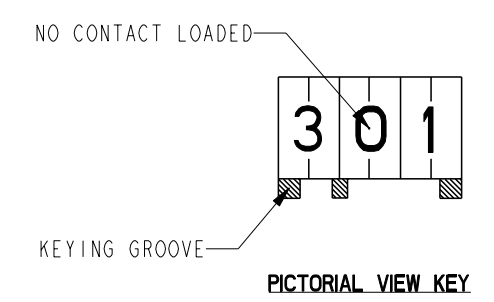

THIS DRAWING IS A CONTROLLED DOCUMENT.		OWN BOB YANG 12NOV2012	TE Connectivity RAST 2.5 TAB HEADER ASSY SELECTIVE LOADED, TH, VERTICAL, EXTERNAL LOCKING	
DIMENSIONS: mm		CHK HAPYE WU 12NOV2012		
TOLERANCES UNLESS OTHERWISE SPECIFIED: 0 PLC ± 1 PLC ± 2 PLC ±0.20 3 PLC ± 4 PLC ± ANGLES ±° FINISH		NAME YUHONG MAO 12NOV2012	PRODUCT SPEC	RESTRICTED TO
MATERIAL		APPLICATION SPEC	SIZE A1	CAGE CODE 00779
CUSTOMER DRAWING		WEIGHT	DRAWING NO C=1971921	SCALE NTS
		SCALE NTS	SHEET 4	OF 5
			REV A9	

THIS DRAWING IS UNPUBLISHED. RELEASED FOR PUBLICATION 20
 © COPYRIGHT 20 BY - ALL RIGHTS RESERVED.

LOC		DIST		REVISIONS			
P	LTR	DESCRIPTION	DATE	DWN	APVD		
-	-	SEE SHEET 1	-	-	-		

FOR ANY KEYING CONFIGURATION, THERE ARE EIGHT COLORS AVAILABLE, BESIDES THE NATURAL COLOR, THERE ARE OTHER SEVEN COLORS, INCLUDE: YELLOW, BLUE, GREY, PURPLE, RED, GREEN, BLACK. THE WHITE VERSION IS PRELIMINARY. THE P/N OF THE COLOR CONNECTOR ARE BASED ON THE NATURAL CONNECTOR, THE PREFIX AND POSTFIX ARE THE SAME FOR THE SAME KEYING CONFIGURATION, BUT THE BASE NUMBERS ARE DIFFERENT ACCORDING TO DIFFERENT COLOR. THE FOLLOWING SHOWS WHAT'S THE P/N FOR COLOR CONNECTOR

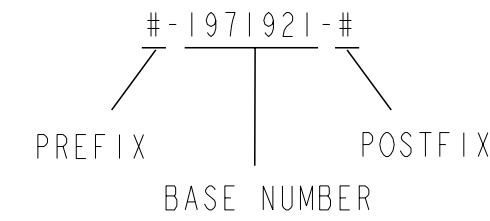

COLOR	PART NUMBER OF THE CONNECTOR ⁵				COMMENTS
	WITH TIN PLATING CONTACT		WITH AG PLATING CONTACT		
NATURAL	#-1971921-#	#-1971922-#	#-1971923-#	#-1971924-#	THE DETAIL P/N FOR DIFFERENT KEYING SEE SHEET 2 & 3
RED	#-2232189-#	#-2232190-#	#-2232191-#	#-2232192-#	THE PREFIX AND POSTFIX ARE THE SAME WITH THE P/N OF THE NATURAL CONNECTOR FOR THE SAME KEYING CONFIGURATION, JUST THE BASE NUMBERS ARE DIFFERENT BASED ON DIFFERENT COLOR. # CAN BE THE NUMBER FROM 0 TO 9.
BLUE	#-1971984-#	#-1971985-#	#-2232193-#	#-2232194-#	
YELLOW	#-2232195-#	#-2232196-#	#-2232197-#	#-2232198-#	
BALCK	#-2232199-#	#-2232200-#	#-2232201-#	#-2232202-#	
GREY	#-2232203-#	#-2232204-#	#-2232205-#	#-2232206-#	
GREEN	#-2232207-#	#-2232208-#	#-2232209-#	#-2232210-#	
PURPLE	#-2232211-#	#-2232212-#	#-2232213-#	#-2232214-#	
WHITE	#-2232285-#	#-2232286-#	#-2232287-#	#-2232288-#	

FOR EXAMPLE, IF A CONNECTOR WITH THE CONFIGURATION AS BELOW, AND WITH TIN PLATING CONTACT, IN THE SHEET 4, WE CAN FIND THE RELATED CONNECTOR P/N WITH NATURAL COLOR IS 3-1971921-3, THEN WE CAN LOOK IN THE ABOVE TABLE TO FIND THE CONNECTOR P/N WITH RED COLOR IS 3-2232189-3

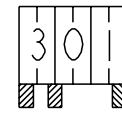

THIS DRAWING IS A CONTROLLED DOCUMENT.		DWN: 12NOV2012 WINTER WANG	STE TE Connectivity		
DIMENSIONS: mm		CHK: 12NOV2012 HAPYE WU			
TOLERANCES UNLESS OTHERWISE SPECIFIED:		APVD: 12NOV2012 YUHONG MAO	NAME: RAST 2.5 TAB HEADER ASSY SELECTIVE LOADED, TH, VERTICAL, EXTERNAL LOCKING		
0 PLC ± 1 PLC ± 2 PLC ±0.2 3 PLC ± 4 PLC ±		PRODUCT SPEC: -	SIZE: A2	CAGE CODE: 00779	DRAWING NO: C-1971921
ANGLES ±° FINISH		APPLICATION SPEC: -	RESTRICTED TO: -	SCALE: 5:1	
MATERIAL: -		WEIGHT: -	SHEET: 5 OF 5		REV: A9
		Customer Drawing			

单击下面可查看定价，库存，交付和生命周期等信息

[>>TE Connectivity\(泰科\)](#)