

REV. LIST		REVISIONS				
NO.	DATE	DESCRIPTION	ECN	DATE	DWN	APPD
0		RELEASED	FJ00-2221-01	01APR02	YK	NS
A		REVISED	FJ00-1011-02	13MAY02	YK	NS

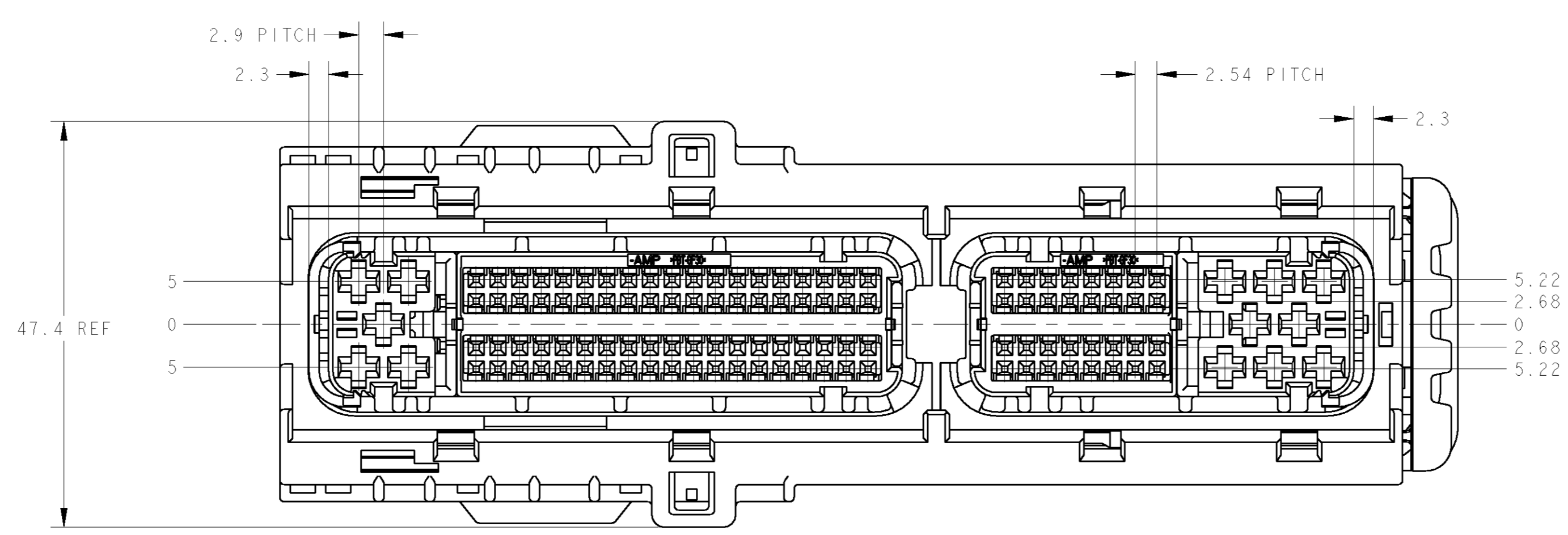
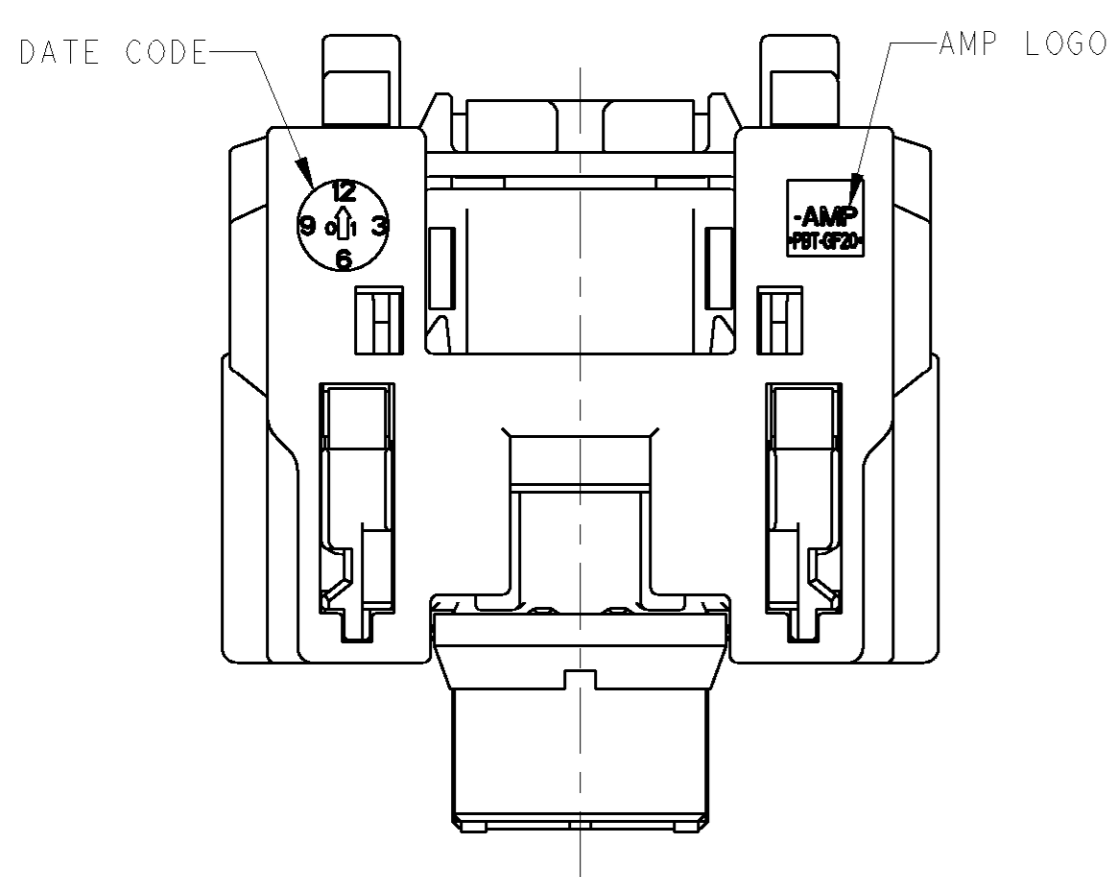
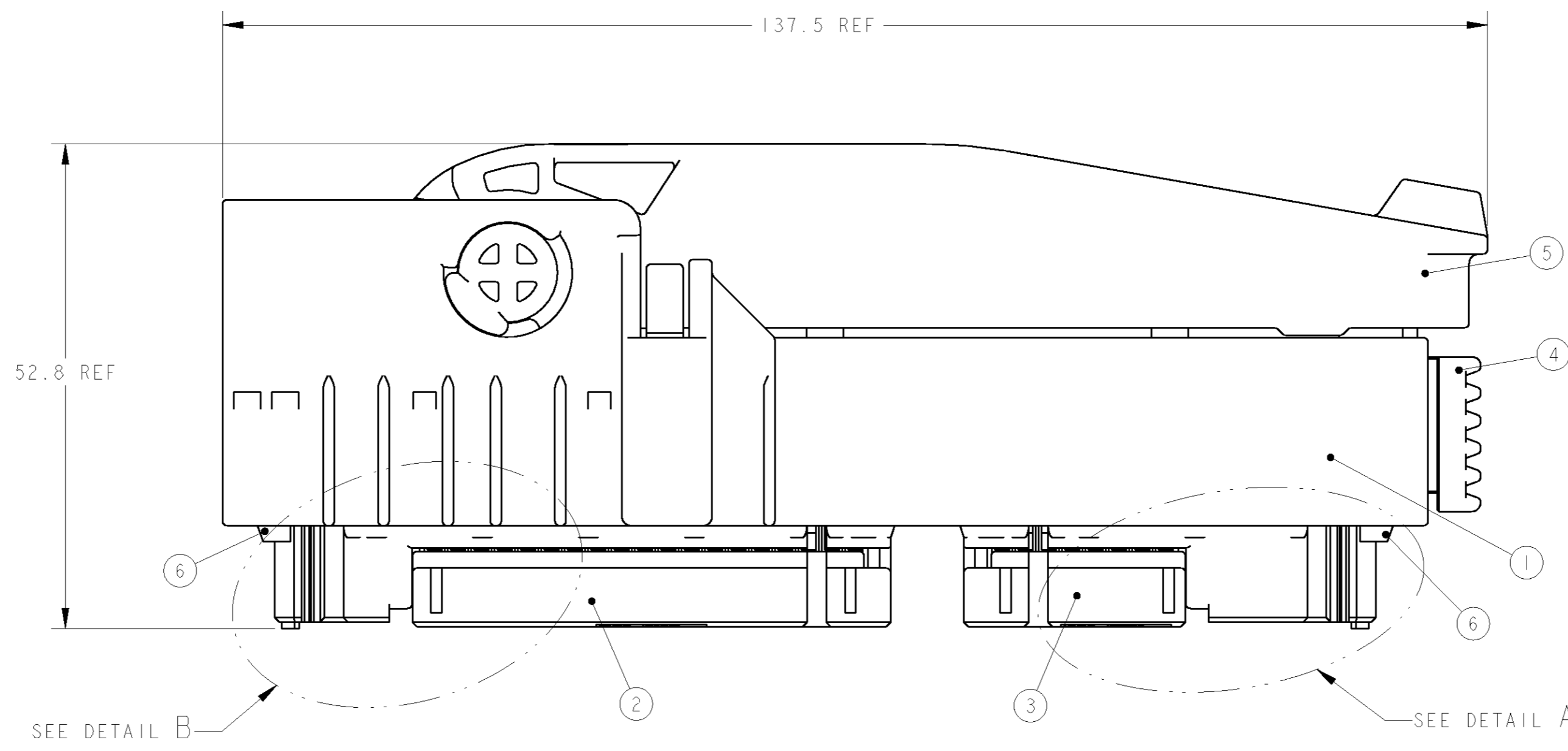
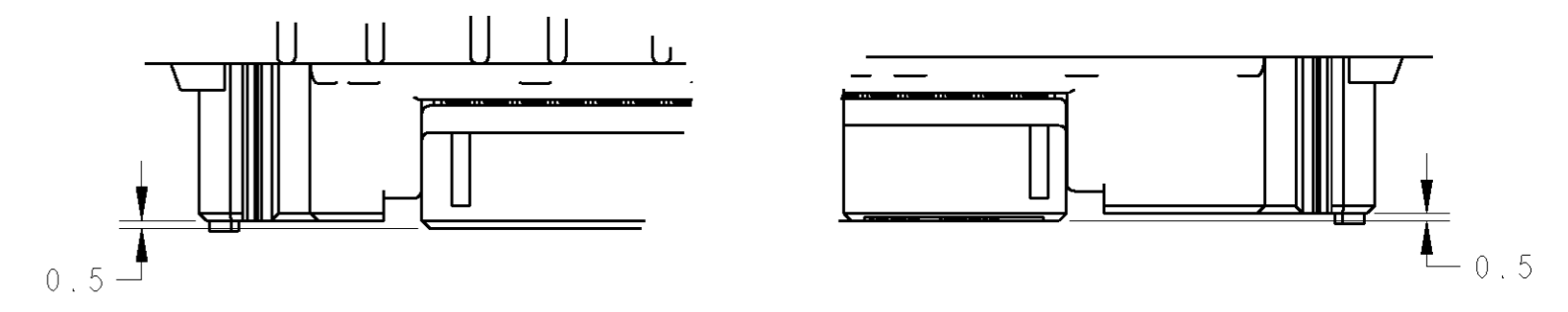
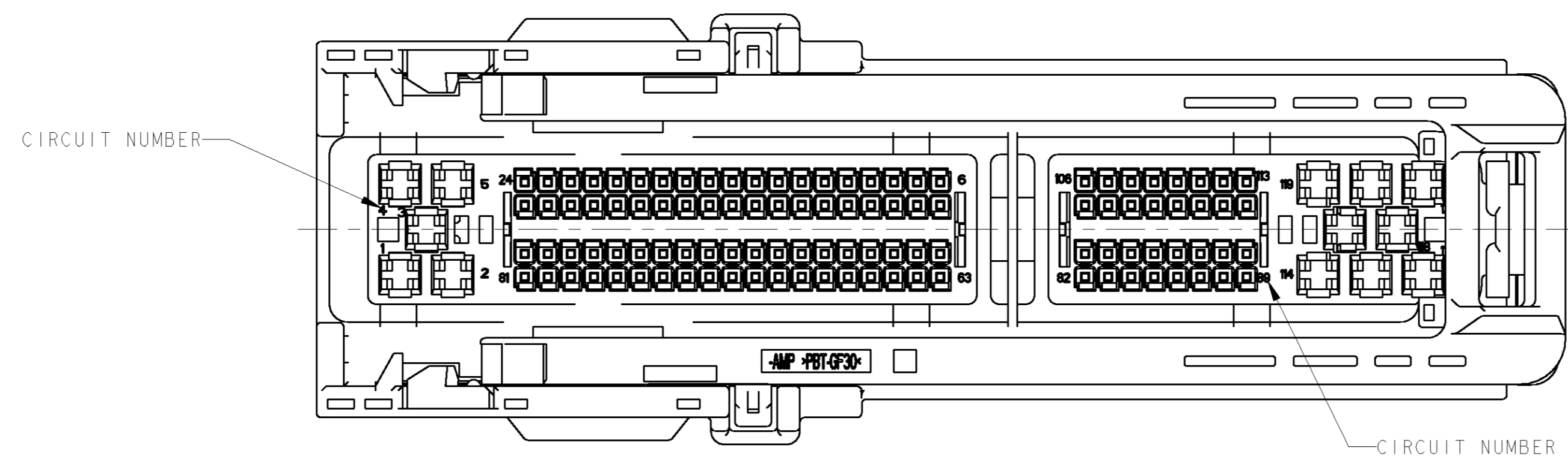

- PART NUMBER OF HARNESS COVER TO BE APPLIED ; P/N 1565422-1
 - APPLIED TERMINAL ; SEE TABLE-1
 - PART NUMBER OF CAP HOUSING TO BE MATED ; P/N 1241434-1
 - INSTRUCTION SHEET NO ; 411-78022
1. 適用ハーネスカバー型番は、P/N 1565422-1
 2. 適用端子はTABLE-1参照
 3. 嵌合相手型番は、P/N 1241434-1
 4. 取扱説明書 NO ; 411-78022

	2	JPT RETAINER	YELLOW	6
	1	LEVER	BLACK	5
	1	SLIDER	BLACK	4
	1	40P MOS RETAINER	GRAY	3
	1	81P MOS RETAINER	GRAY	2
	1	PLUG HSG	BLACK	1
1565416-1		PART NAME	COLOR	No

TABLE-1

	CONTACT	MOS	JPT
PART NUMBER	968220-1	968221-1	964284-2 965999-2
WIRE SIZE (mm ²)	0.2-0.5	0.75	0.5-1.0 >1.0-2.0

DIMENSIONS: mm		TOLERANCES UNLESS OTHERWISE SPECIFIED: mm: ±0.3		DWN: T. KAWAHARA CHK: T. KOHNO APPD: N. SAI		Tyco Electronics AMP K.K. Kawasaki, Japan	
MATERIAL: PBT		FINISH: SEE TABLE		PRODUCT SPEC: 108-5799		PLUG ASSY 121POS MOS CLEAN BODY/JPT	
				APPLICATION SPEC: 114-18021, 114-18050-1		SIZE: 00779	
				WEIGHT: 117.4 g		DRAWING NO: 1565416	
				CUSTOMER DRAWING		SHEET 1 OF 2 REV A	

REV. LIST		REVISIONS			
NO.	DATE	DESCRIPTION	ECN	DATE	BY
1		SEE SHEET 1			

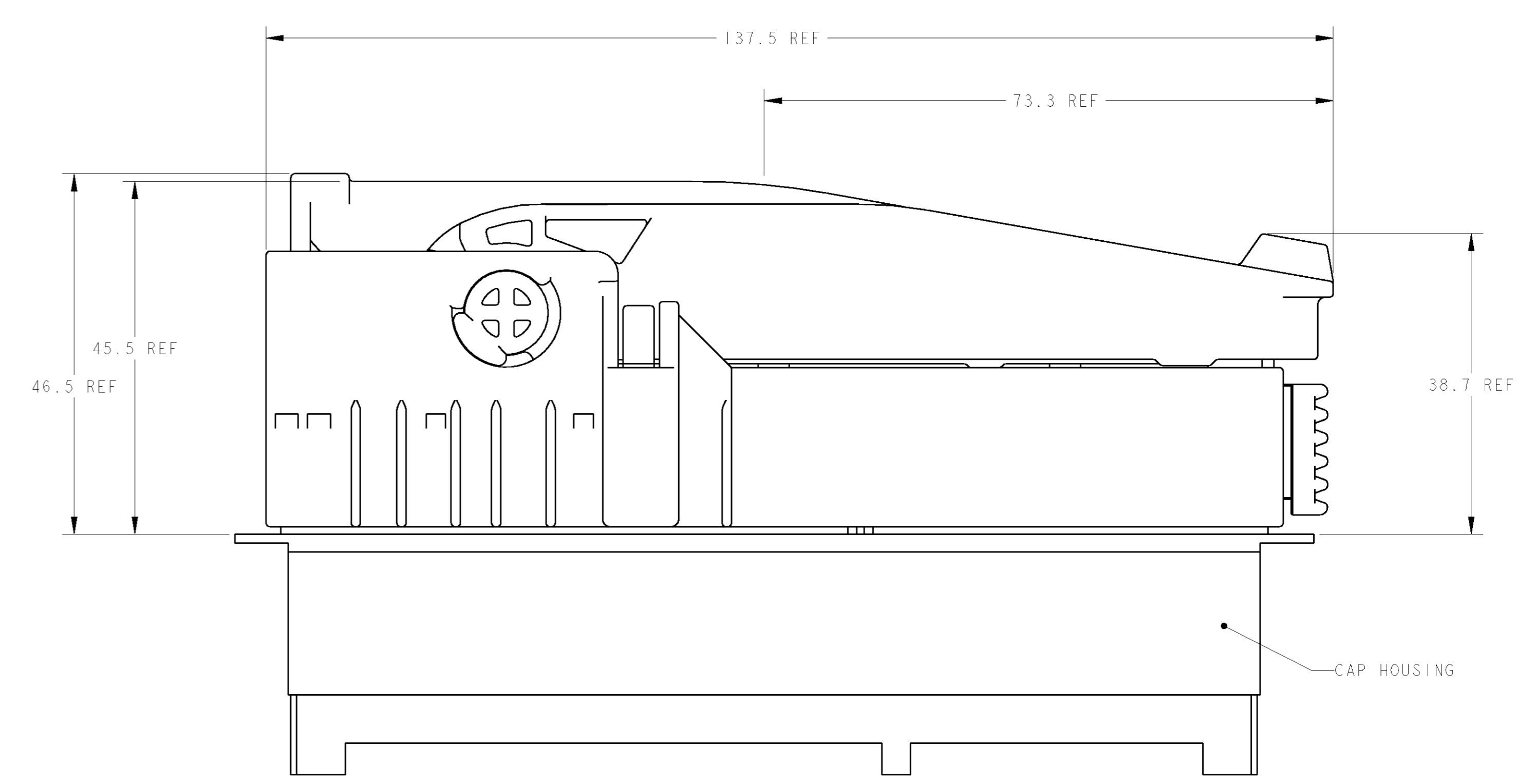
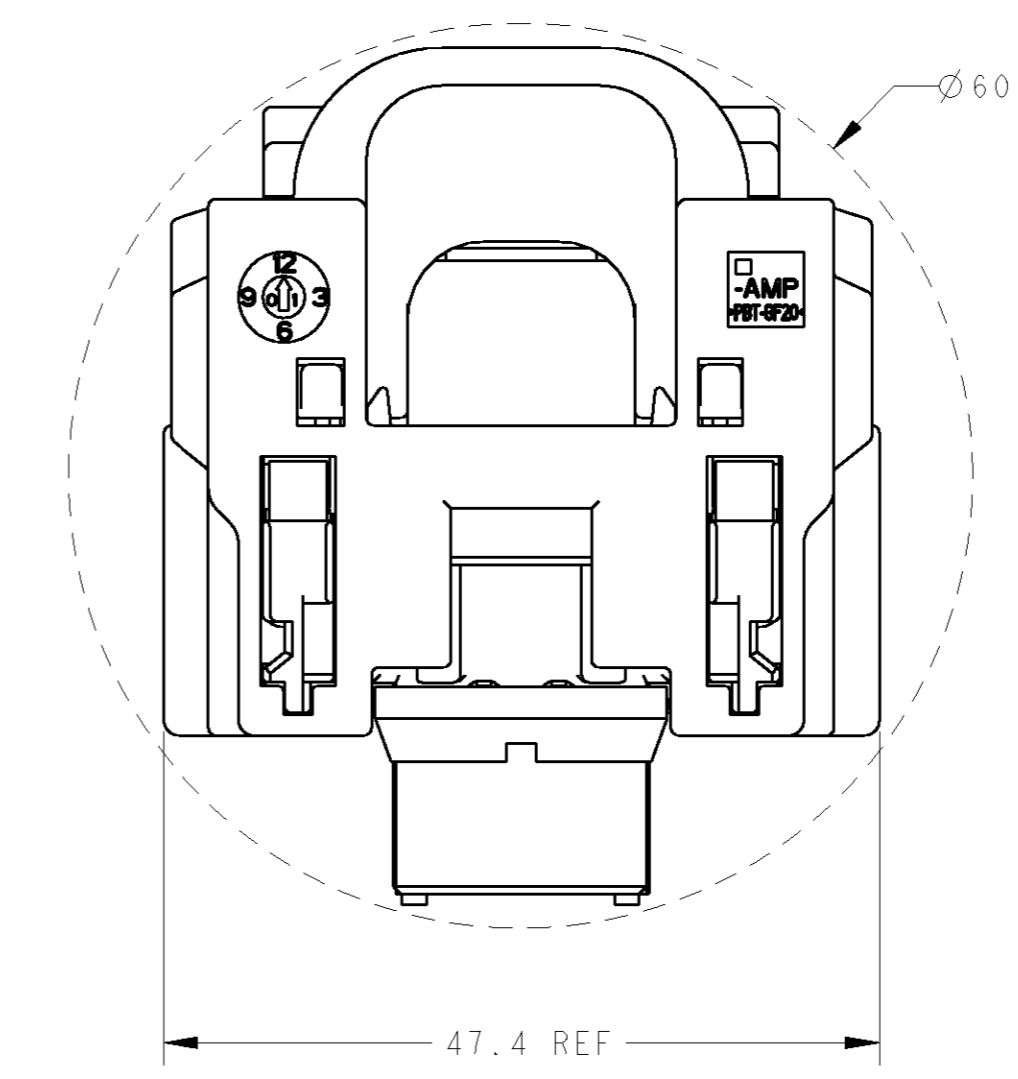
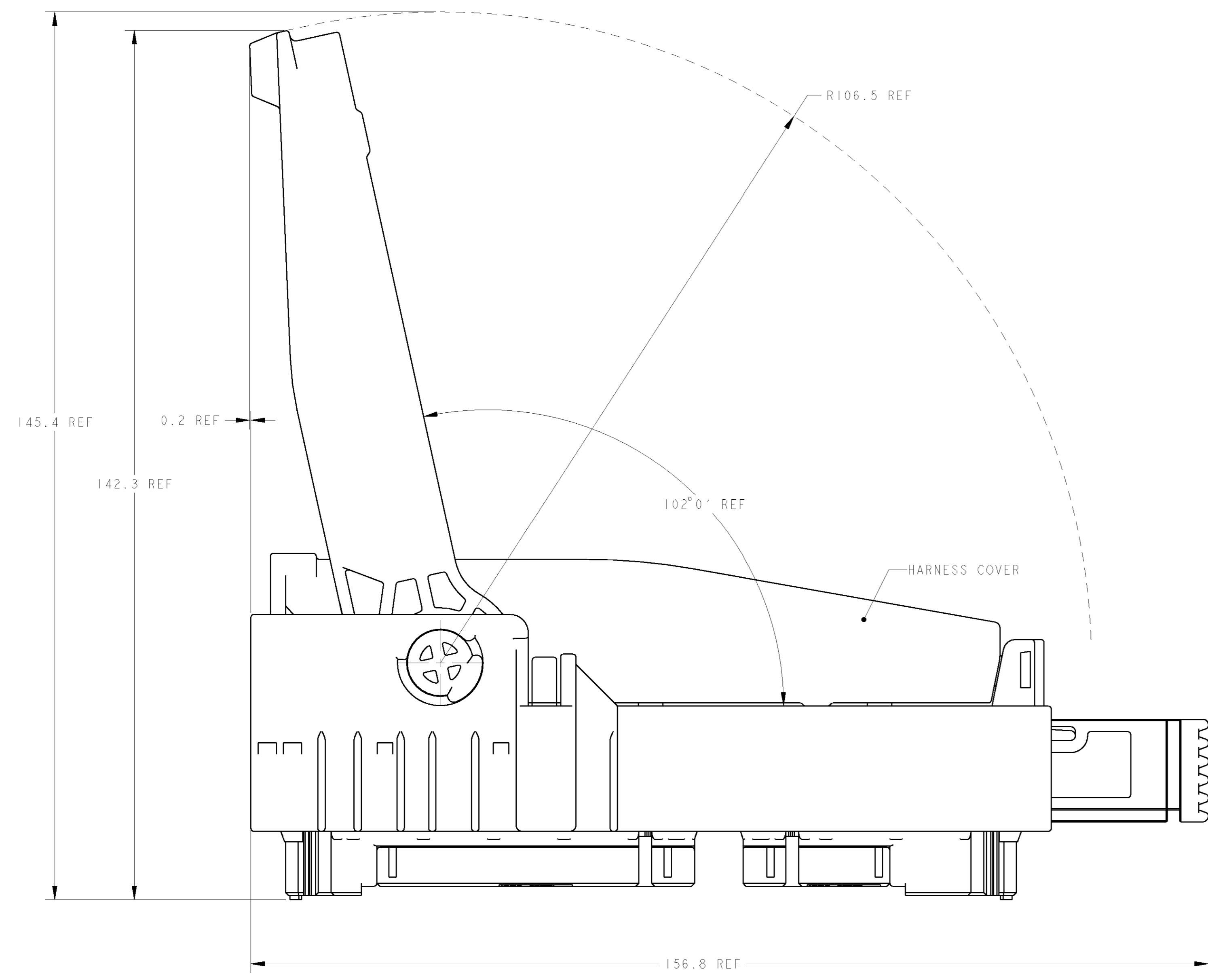

BEFORE MATING

AFTER MATING

- THIS DRAWING SHOWS ASSEMBLY CONDITION OF 1565416-1 AND 1565422-1(HARNESS COVER) AND IT IS DIFFER FROM SHIPPING CONDITION.
- 本図は、1565416-1に1565422-1(ハーネスカバー)をアッセンブルしたものであり、出荷形態とは異なる。

DIMENSIONS: mm TOLERANCES UNLESS OTHERWISE SPECIFIED: FRACTIONAL DECIMAL 1-PLC ±0.3 2-PLC ±0.5 3-PLC ±0.13 4-PLC ±0.013 ANGLES 10° 00' ±0.001		DWN T. KAWAHARA CHK T. KOHNO APVD M. SAI PRODUCT SPEC 108-5799 APPLICATION SPEC 114-18021, 114-18050-1 WEIGHT 117.4 g		DTAPR02 DTAPR02 DTAPR02 NAME FOR PLUG ASSY 121POS MQS CLEAN BODY/JPT SIZE CAGE CODE DRAWING NO. 00779 C=1565416 CUSTOMER DRAWING		Tyco Electronics AMP K.K. Kawasaki, Japan RESTRICTED TO	
--	--	---	--	---	--	---	--

单击下面可查看定价，库存，交付和生命周期等信息

[>>TE Connectivity\(泰科\)](#)