

LOC		DIST		REVISIONS			
P	LTR	DESCRIPTION	DATE	DWN	APVD	REV	APPD
AD	00	AA2	REVISED PER ECO-20-006229	21MAY2020	KR	JS	

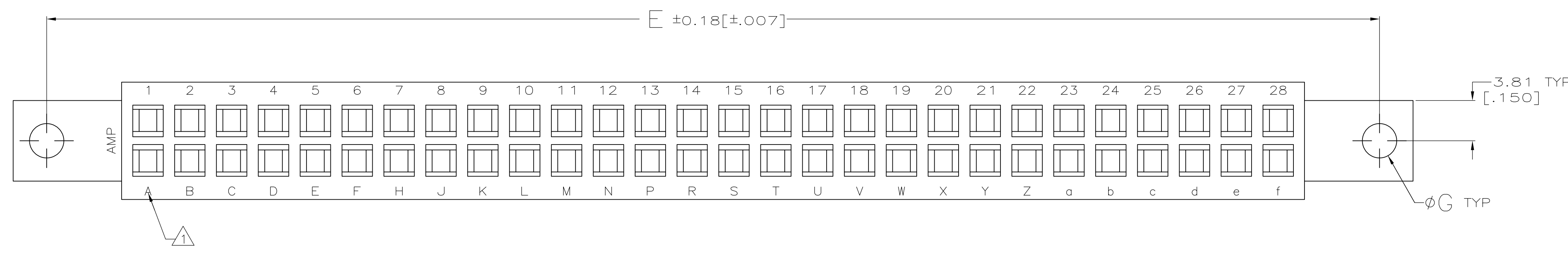

THIS DRAWING IS A CONTROLLED DOCUMENT.		DWN J. GALLUCCI BG 12-10-92	CHK H. ROSE 3/2/94	APVD H. ROSE 3/2/94	NAME
DIMENSIONS: MM(INCHES)		TOLERANCES UNLESS OTHERWISE SPECIFIED:		PRODUCT SPEC	
MATERIAL GLASS FILLED POLYESTER COLOR: BLACK		FINISH		APPLICATION SPEC	
0 PLC ± -		1 PLC ± -		2 PLC ± -	
3 PLC ± 0.13[.005]		4 PLC ± -		ANGLES ± -	
CUSTOMER DRAWING		WEIGHT		SCALE 4:1	
SIZE A1		CAGE CODE 00779		DRAWING NO. 583859	
SHEET 1 OF 2		REV AA2		RESTRICTED TO	

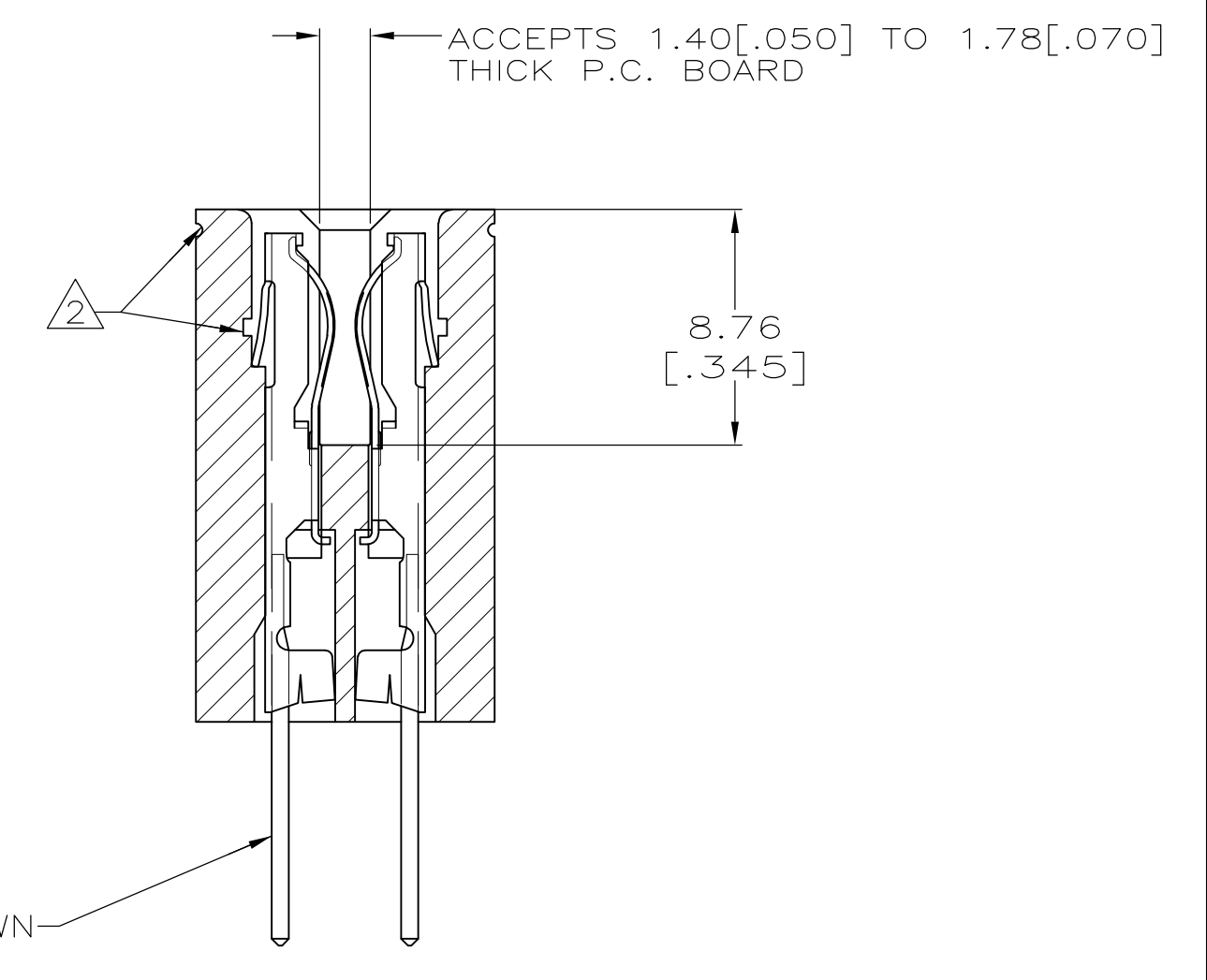
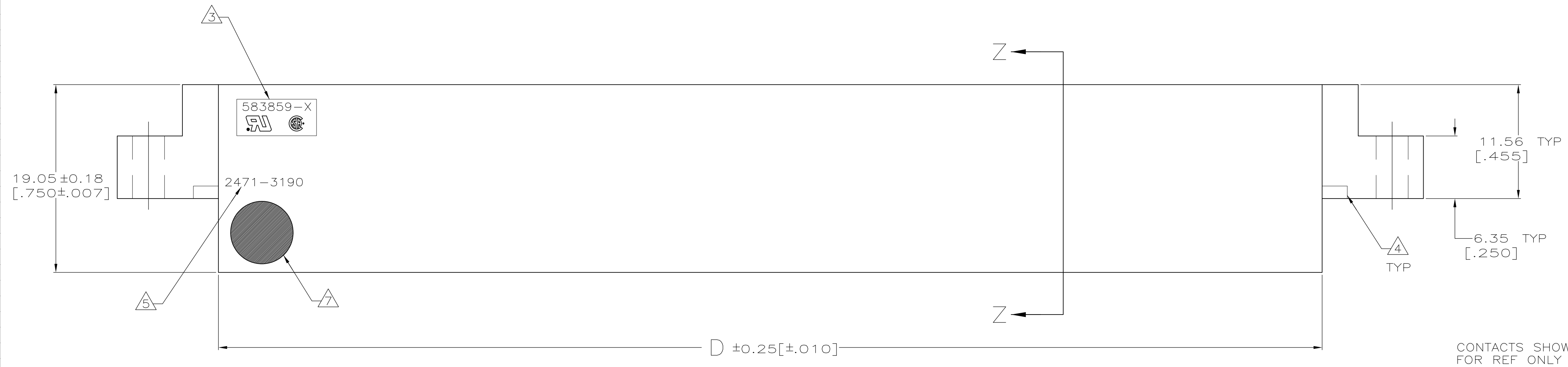
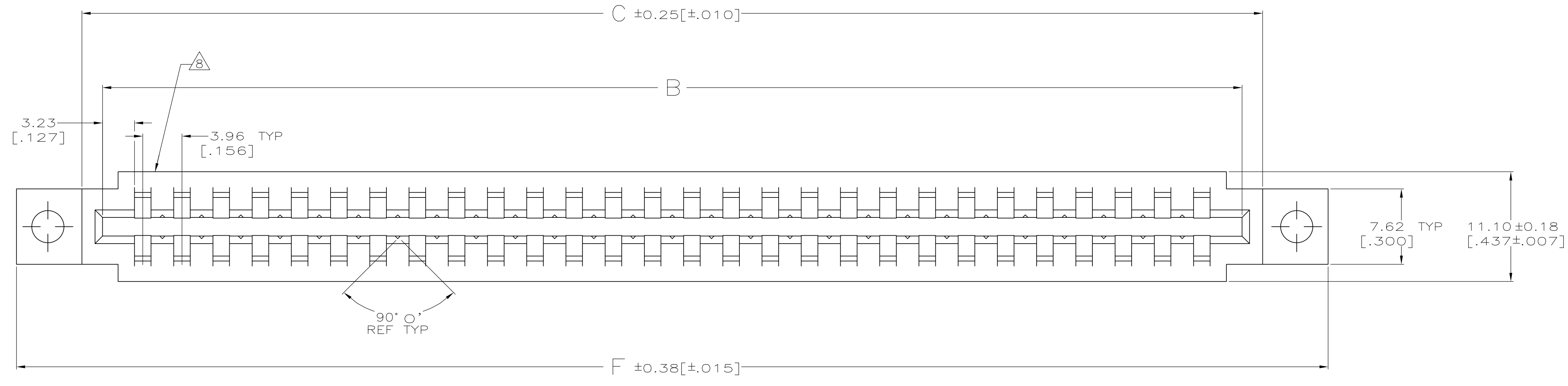
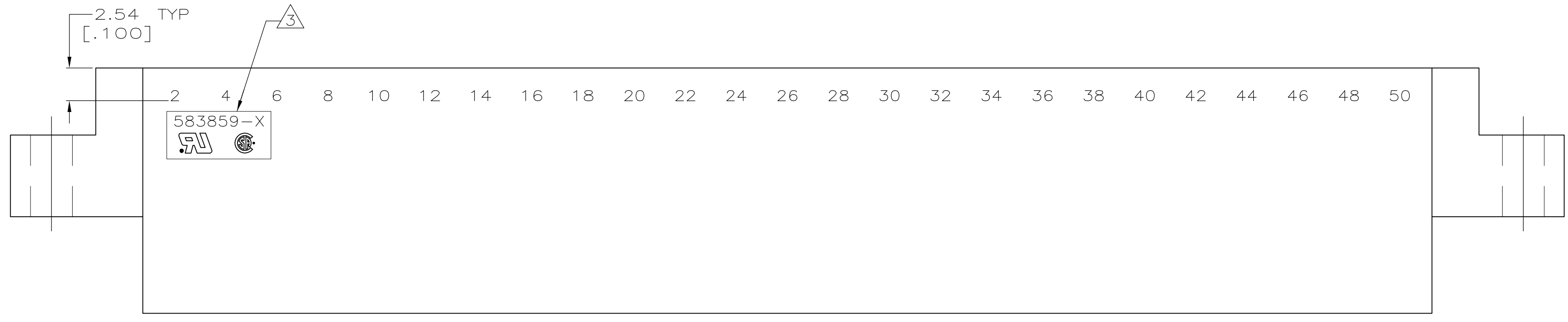

- 1 FIRST 22 POSITIONS MARKED WITH UPPER CASE LETTERS, FOLLOWED BY LOWER CASE LETTERS, FOLLOWED BY UPPERCASE AA,AB,AC ETC. CHARACTERS G,I,O AND Q ARE OMITTED. SEE TABLE FOR END CAVITY IDENTIFICATION.
- 2 PULL GROOVES OPTIONAL THESE LOCATIONS REF ONLY.
- 3 HOUSING PART NUMBER, UL & CSA LOGO'S TO BE MOLDED IN THIS AREA. UL LOGO PER 1-18838-3, CSA LOGO PER 1-18839-3.
- 4 CORING AT AMP'S OPTION REF ONLY.
- 5 HOT STAMP CUSTOMER PART NUMBER 2471-3190 IN THIS AREA FOR 1-583859-7 ONLY.
- 6 STAMPED WITH SPECIAL CAVITY IDENTIFICATION ON SIDES OF HOUSING.
- 7 $\phi 6.35 \pm 0.38 [.250 \pm 0.015]$ WHITE DOT IN LOWER LEFT HAND CORNER.
- 8 DATE CODE TO BE MOLDED IN THIS AREA

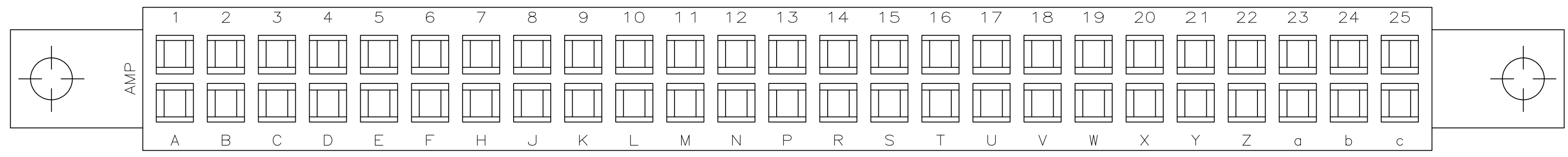

1 OBSOLETE	10 & L	.128	2.409	2.159	1.600	1.888	1.724	10	2-583859-8
OBSOLETE	14 & R	.128	3.033	2.783	2.224	2.512	2.348	14	2-583859-7
2 OBSOLETE	25 & c	.128	4.749	4.500	3.940	4.228	4.064	25	2-583859-5
	36 & r	.128	6.465	6.215	5.656	5.944	5.780	36	2-583859-3
	8 & J	.128	2.097	1.847	1.288	1.576	1.412	8	2-583859-1
OBSOLETE	24 & b	.128	4.593	4.343	3.784	4.072	3.908	24	1-583859-9
3 OBSOLETE	28 & f	.128	5.217	4.967	4.408	4.696	4.532	28	1-583859-7
	12 & N	.128	2.721	2.471	1.912	2.200	2.036	12	1-583859-5
	6 & F	.128	1.785	1.535	.976	1.264	1.100	6	1-583859-3
OBSOLETE	18 & V	.156	3.657	3.407	2.848	3.136	2.972	18	1-583859-1
	10 & L	.128	2.409	2.159	1.600	1.888	1.724	10	583859-9
	15 & S	.128	3.189	2.939	2.380	2.668	2.504	15	583859-7
	18 & V	.128	3.657	3.407	2.848	3.136	2.972	18	583859-5
	22 & Z	.128	4.281	4.031	3.472	3.760	3.596	22	583859-3
	28 & f	.128	5.217	4.967	4.408	4.696	4.532	28	583859-1
	END CAVITY IDENT								
		G	F	E	D	C	B	POSN	PART NUMBER

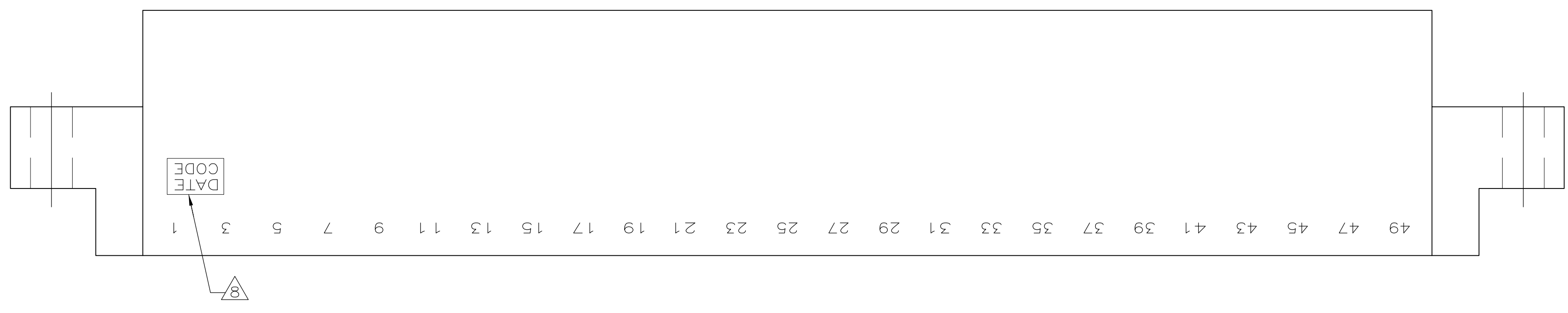

2-583859-5

THIS DRAWING IS A CONTROLLED DOCUMENT. 12-10-92

CHK: J. GALLUCCI BG
 H. ROSE 3/2/94
 APVD: H. ROSE 3/2/94

NAME: STE TE Connectivity

PRODUCT SPEC: HOUSING, CRIMP SNAP TWIN LEAF, .156" WITH MOUNTING EARS

APPLICATION SPEC: -

SIZE: A1 CAGE CODE: 00779 DRAWING NO: 583859

MATERIAL: - FINISH: - WEIGHT: -

CUSTOMER DRAWING SCALE: 4:1 SHEET: 2 OF 2 REV: AA2

单击下面可查看定价，库存，交付和生命周期等信息

[>>TE Connectivity\(泰科\)](#)