

Figure 1

1. INTRODUCTION

These instructions cover Crimp Quality Monitor (CQM) Adapter 122990-[], which is used with AMP-O-LECTRIC Model "G" Terminating Machines 354500-[] and 1213127-[], and CQM Adapter 1424265-1, which is used with the AMP 3K Terminating Machines 1725950-[] and AMP 5K Terminating Machines 1725900-[]. These adapters are used in conjunction with Crimp Quality Monitor 2031940-1.

For additional information regarding operation, setup, and adjustment of the AMP 3K/5K Terminating Machines, refer to Customer Manual 409-10047. For additional information on the Crimp Quality Monitor, refer to Customer Manual 409-10091.

Reasons for reissue are provided in Section 9, REVISION SUMMARY.

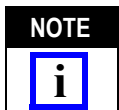

All dimensions are in millimeters [with inches in brackets]. Illustrations are for identification only and are not drawn to scale.

2. DESCRIPTION

The CQM Adapter consists of two sensor assemblies, mounting hardware, and a cable. These items allow the Crimp Quality Monitor to monitor the crimping process without the use of special applicators.

3. INSTALLATION

3.1. Mounting the Base Plate Sensor (Figure 2)

DANGER  To avoid personal injury, disconnect all power to the terminating machine and to the Crimp Quality Monitor before performing the following operations.

1. Remove the existing base plate assembly from the terminating machine.
2. Remove all components from the existing base plate assembly, and install them in the same locations on the base plate sensor assembly supplied with the CQM Adapter.
3. Clean the mounting surface, then install the new base plate sensor assembly on the terminating machine.
4. Check the alignment of the base plate with the terminating machine ram.
5. Make alignment corrections, if necessary.
6. Check the shut height.
7. If shut height corrections are necessary, use the supplied shims.

NOTE  To check the shut height or if shut height corrections are necessary, refer to the appropriate machine manual.

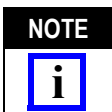
NOTE  If installing a new ram (see Paragraph 3.2), check the shut height after installing the new ram.

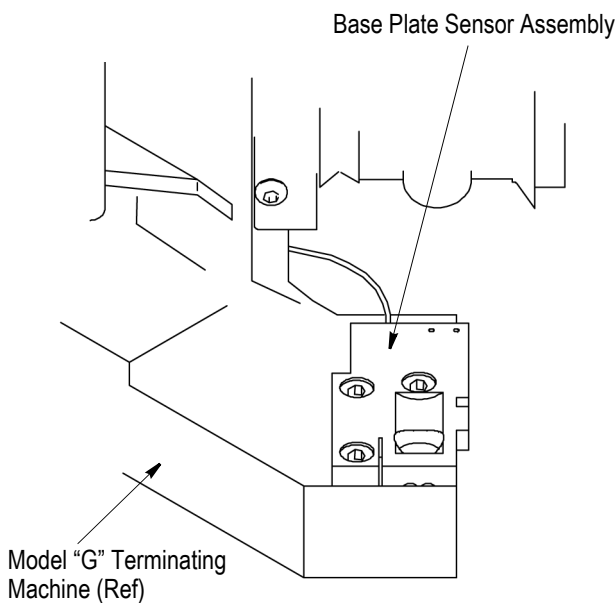

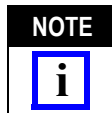

Figure 2

3.2. Replacing the Ram and Gib

Early Model "G" Terminating Machines do not have the mounting features needed for the CQM Adapter. These machines will have to have the ram and a gib replaced (included in PN 1-122990-0). For those units that have the proper mounting features, skip to Paragraph 3.3, Installing Position Sensor Kit.

DANGER  To avoid personal injury, disconnect all power to the Model "G" Terminating Machine and to the Crimp Quality Monitor before performing the following operations.

NOTE  If your Model "G" Terminating Machine is not an auto-adjust unit, skip to Step 4.

1. Remove the terminating machine top cover.
2. Disconnect the auto-adjust subassembly.
3. Remove the auto-adjust subassembly.
4. Remove the gibs.
5. Remove the ram.
6. Remove the components from the old ram assembly and install them in the same locations on the new ram.
7. Install the new ram assembly into the terminating unit.
8. Replace the left-side (when facing terminating unit) gib with the new gib and re-install the existing right-side gib.

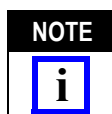
NOTE  If your Model "G" Terminating Machine is not an auto-adjust unit, skip to Step 12.

9. Install the auto-adjust subassembly (check the shaft alignment).
10. Re-connect the auto-adjust subassembly.
11. Replace the top cover.
12. Check the shut height.
13. If shut height corrections are necessary, use the supplied shims.

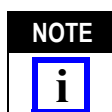
NOTE  To check the shut height or if shut height corrections are necessary, refer to the appropriate machine customer manual.

3.3. Installing Position Sensor Kit (Figure 3)

DANGER  To avoid personal injury, disconnect all power to the terminating machine and to the Crimp Quality Monitor before performing the following operations.

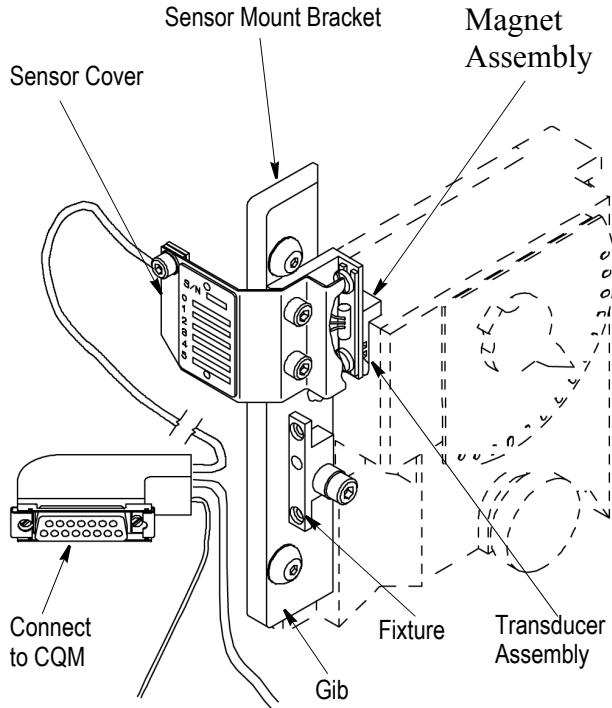

Figure 3

1. Position the terminating machine's ram at bottom-dead-center.
2. Remove the position sensor from the sensor bracket. Install the fixture onto the sensor bracket by using the two screws from the sensor. See Figure 4.

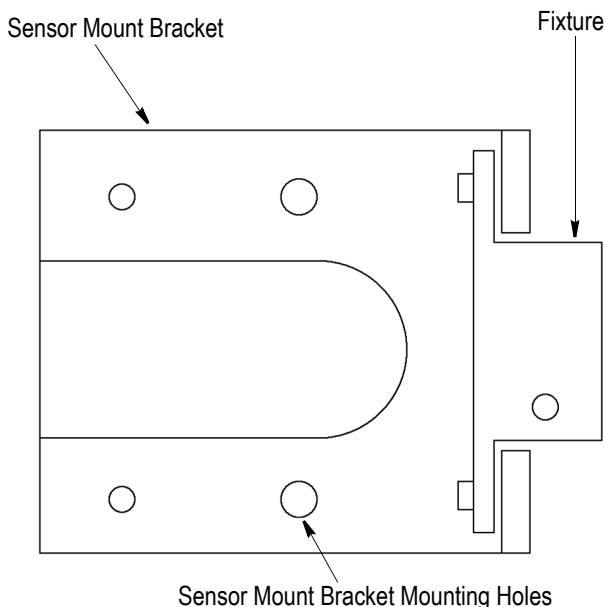



Figure 4

3. Loosely fasten the sensor bracket to the left side gib, making sure that the fixture is in the magnet cavity of the ram.
4. Using the long screw, fasten the fixture to the ram cavity. Tighten screw. This positions the sensor bracket relative to the magnet in the ram.
5. Tighten the sensor bracket mounting screws. Remove the fixture and fasten it to the gib as shown in Figure 3. Fasten the sensor magnet with the chamfered edges down in the ram cavity. (You may hand cycle the ram up to install the sensor magnet.)
6. Install the transducer assembly to the sensor bracket with the position sensor oriented on the lower half and toward the ram.
7. When the system is completely assembled, the sensor will have to be adjusted. Refer to Section 5, ADJUSTMENT.

3.4. Cable Connections

1. The supplied cable has a 15-position subminiature "D" connector which mates to the connector labeled  on back of the Crimp Quality Monitor.
2. The cable splits into two sections. The four-position connector goes to the base plate and the three-position connector goes to the position sensor.
3. The four-position connector can attach to the base plate in either of two orientations (either 0 or 180 degrees); either orientation will work correctly.
4. The three-position connector has a mark to indicate position 1 on the connector. Align this mark with the corresponding mark on the position sensor's connector and attach the connectors.
5. The sensor cover provides a strain relief for the cable that connects to the position sensor. A cable clamp mounts to the cover with a socket head screw and hex nut. Slide the cable clamp onto the cable and loosely mount the clamp to the cover. Position the cover in its proper location and adjust the cable to provide ample strain relief. Tighten the cable clamp hardware.
6. Attach the cover to the sensor bracket with the two screws provided.

4. OPERATION

Refer to Customer Manual 409-10091 for Crimp Quality Monitor operating instructions. The six position sensor numbers located on the sensor cover must be entered on the CQM SYSTEM SETTINGS/POSITION SENSOR screen.

5. ADJUSTMENT



To avoid personal injury, be very careful of moving mechanisms when making adjustments while the terminating machine is "on."



Set precision adjust to tightest setting (-9).



This adjustment should be made only by qualified personnel under the guidance of Tyco Electronics.

1. Jog the machine ram down until the ram is in the bottom-dead-center position.
2. Check the Crimp Quality Monitor SENSORS DIAGNOSTICS screen for a height reading of 900 to 1100. If the monitor screen does not indicate 900 to 1100, adjust as follows:
 - a. Remove the two screws securing the sensor cover.
 - b. Loosen the two screws securing the sensor.
 - c. Watching the monitor diagnostics sensor screen, move the sensor "up" to decrease the position sensor reading; "down" to increase the position sensor reading until the position sensor reading is between 900 and 1100.
 - d. Tighten the screws securing the sensor.
 - e. Replace the cover and secure it with the two screws removed earlier.
3. Return the machine ram to the top-dead-center position.
4. Re-adjust precision adjust to .00 mm [.000 in.].

6. INSPECTION/MAINTENANCE

6.1. Daily Inspection/Maintenance

It is recommended that each operator be made aware of and responsible for the following daily maintenance steps.

1. Check the position sensor reading (Crimp Quality Monitor SENSORS DIAGNOSTICS menu) to be sure that the position sensor reading is in the proper range. Adjust, if necessary according to Section 5, ADJUSTMENT.
2. Inspect all wiring for any damaged cables or unmated connectors.
3. Clean all crimping areas in accordance with the instructions for the Heavy Duty Miniature Applicator.

4. Ensure that the applicator that is mounted in the terminating machine is held securely by both the base plate and the applicator ram lock.

6.2. Periodic Inspection/Maintenance

Regular inspection should be performed by Quality Control personnel. A record of scheduled inspections should remain with the CQM system and/or be supplied to supervisory personnel responsible for the system. Though recommendations call for at least one inspection a month, the inspection frequency should be based on the amount of use, working conditions, operator training and skill, and established company standards. These inspections should be performed in the following sequence.

1. Make sure all screws, cables, and connectors are in place.
2. Check all parts for wear. Remove and replace worn components.
3. Inspect the crimp area for flattened, cracked, worn, or broken areas. If damage is evident, the tooling must be repaired before returning it to service. Refer to the terminating machine and applicator instructions.

7. REPAIR/REPLACEMENT



Do not remove or perform any maintenance on components not explicitly called for in this instruction sheet. Damage could be done to the entire Crimp Quality Monitor system.

7.1. Troubleshooting/Repair of Sensor Wiring

The Crimp Quality Monitor requires continuous electrical flow through the force and position sensors on the terminating machine in order to acquire the necessary data points to analyze a crimp. If the electrical path is broken by a damaged connector or wire, the monitor will not be able to analyze the data in order to calibrate or report the crimp status.

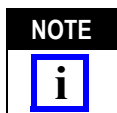

The following error messages could indicate a broken electrical path:

- "NOT ENOUGH VALID POINTS" (Calibrate Mode)
- "INVALID CRIMP" (Run Mode)

To check the sensor wiring, proceed as follows:

1. Select DIAGNOSTICS from the Crimp Quality Monitor main menu.
2. Select 2-SENSORS from the DIAGNOSTICS menu.
3. Using the terminating machine's Jog Mode, crimp a terminal without wire, and observe the FORCE and POSITION readings.



Terminals may get stuck in the tooling when crimped without wire. A stuck terminal must be cleared from the tooling to avoid tooling breakage during successive crimps.

a. The force reading should start at a value between 0 and 300, gradually increase to a value less than 4095 at bottom-dead-center and then gradually return to approximately the same starting value.

b. The position reading should start at a value between 2000 and 3000, increase to a maximum less than 4095, then decrease to minimum between 900 and 1800 at bottom-dead-center.



The position sensor value should not go below 900 during this cycle. If necessary refer to Section 5, ADJUSTMENT for position sensor adjustment.

4. If the sensor values indicate a problem, test the cable between the Crimp Quality Monitor and the sensors (Sensor Cable PN 122955-1) with an ohmmeter for continuity, or replace the sensor cable and repeat Steps 1, 2, and 3.

5. If the sensor cable fails the continuity test, replace it. If the cable passes, but the force sensor readings were incorrect, see Paragraph 7.3, Force Sensor Replacement. If the cable passes, but the position sensor readings were incorrect, see Paragraph 7.4, Position Sensor Replacement.

7.2. Force Sensor Removal



To avoid personal injury, disconnect all power to the terminating machine and to the Crimp Quality Monitor before removing the force sensor.

1. Disconnect the sensor cable at the force sensor.



The connector is a locking-style connector and must be removed by pulling on the connector housing. Pulling on the wires will not release the connector and will cause damage to the wires.

2. Remove the base plate's mounting screws and then the base plate.

7.3. Force Sensor Replacement



To avoid personal injury, make sure that power to the terminating machine and Crimp Quality Monitor is disconnected before replacing the force sensor.

1. Remove all components from base plate assembly, and install them in the same location on new base plate sensor assembly.

2. Clean mounting surface, then mount new base plate sensor assembly on terminating machine.

3. Check alignment of the base plate with the terminating machine's ram.

4. Make alignment corrections, if necessary.

5. Connect the cable to the sensor.

7.4. Position Sensor Removal



To avoid personal injury, disconnect all power to the terminating machine and to the Crimp Quality Monitor before removing the position sensor.

1. Remove the sensor cover and disconnect the position sensor assembly.

2. Disassemble the cable clamp from the sensor cable.

3. Disassemble the sensor mount bracket and fixture from the gib.

4. Remove the magnet assembly from the terminating machine's ram.

7.5. Position Sensor Replacement



To avoid personal injury, disconnect all power to the terminating machine and to the Crimp Quality Monitor before replacing the position sensor.

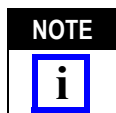

The position sensor kit contains a position sensor, magnet assembly, fixture, and a cover with configuration numbers. These kit parts must be replaced as a set. DO NOT mix the new parts with any of the removed parts.

1. With the machine power disconnected, position the terminating machine's ram at bottom-dead-center.

2. Loosely attach sensor mount bracket to gib with supplied hardware.

3. Mount the fixture to the terminating machine ram and to the sensor mount bracket. The fixture is used to establish the critical distance between the sensor and magnets.

4. Tighten the sensor mount bracket screws.

5. Remove the fixture and store it on the gib as shown in Figure 3.

6. Mount the magnet assembly to the terminating machine ram.

7. Attach the position sensor assembly to the sensor mount bracket.

8. Attach cable clamp to the cable and the cover.

9. Connect the cable to the sensor. Observe the connector orientation marks.
10. Reconnect the power to the machine and turn the machine on.
11. Adjust the sensor according to Section 5, ADJUSTMENT.
12. Attach cover to gib.
13. Enter the position sensor numbers.

8. PARTS REPLACEMENT

Refer to the assembly drawings shipped with the CQM Adapter for replacement part numbers. No spare parts are recommended for this assembly. Order parts through your Tyco Electronics representative, or call 1-800-526-5142, or send a facsimile of your purchase order to 1-717-986-7605, or write to:

CUSTOMER SERVICE (038-035)
TYCO ELECTRONICS CORPORATION
PO BOX 3608
HARRISBURG PA 17105-3608

9. REVISION SUMMARY

Since the previous revision of this instruction sheet, the TE logo has been applied.

单击下面可查看定价，库存，交付和生命周期等信息

[>>TE Connectivity\(泰科\)](#)