



# 698-960 & 1710-2700 MHz LTE WORLD BAND ANTENNA

**Part Numbers: 2372112-1, 2372112-2  
2372112-5, 2372112-6**

## FEATURES & BENEFITS

- Adhesive backing on the FPC simplifies mounting within the device
- Omnidirectional coverage
- Efficient design reduces power usage
- No matching components required
- Ground-plane independent design

## SPECIFICATIONS

<b>Frequency Range (MHz)</b>	698-960	1710-2700
<b>VSWR</b>	< 2.6:1	< 3.0:1
<b>Efficiency</b>	38%	52%
<b>Average Gain</b>	-4.8dBi	-3.7dBi
<b>Peak Gain</b>	-0.2dBi	0.2dBi
<b>Power Handling</b>	10 Watt cw	
<b>Feed Point Impedance</b>	50 ohms unbalanced	
<b>Polarization</b>	Linear	
<b>Size</b>	65 mm x 15 mm x 0.2 mm	
<b>Weight</b>	< 2.0 g	
<b>Mounting</b>	Adhesive Tape	
<b>Mating Connector</b>	MHF and MHF4L type, refer to page5	
<b>Cable (coaxial)</b>	1.13mm Dia. Refer to page5	
<b>Operating Temperature</b>	-40 to +85°C	
<b>Storage Temperature</b>	-40 to +85°C	
<b>Hazardous Materials</b>	A certificate of conformance is available from the product page on TE website.	

## RF DATA

### VSWR

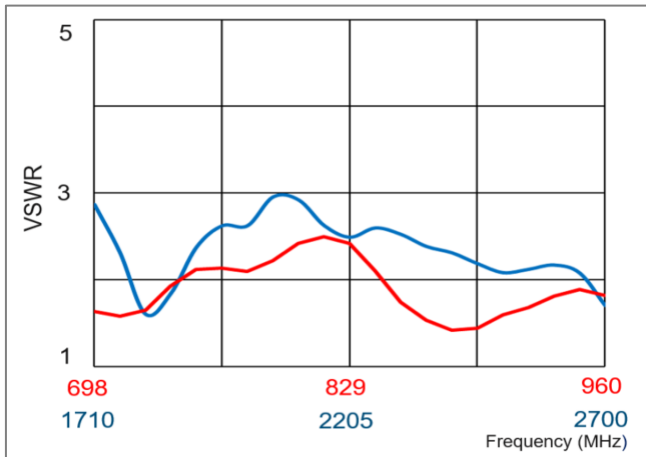

### Return Loss

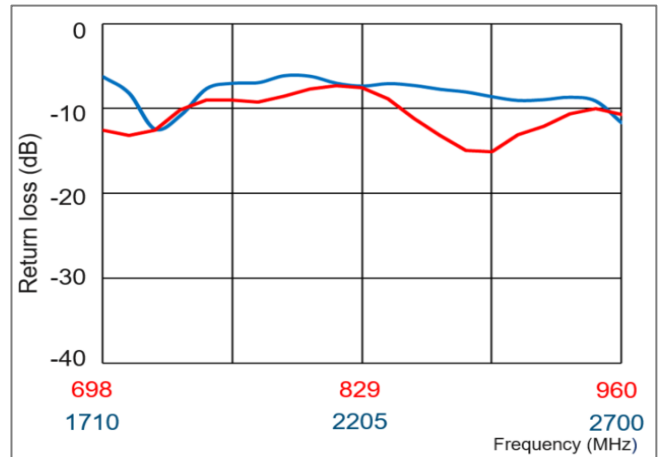

### Efficiency

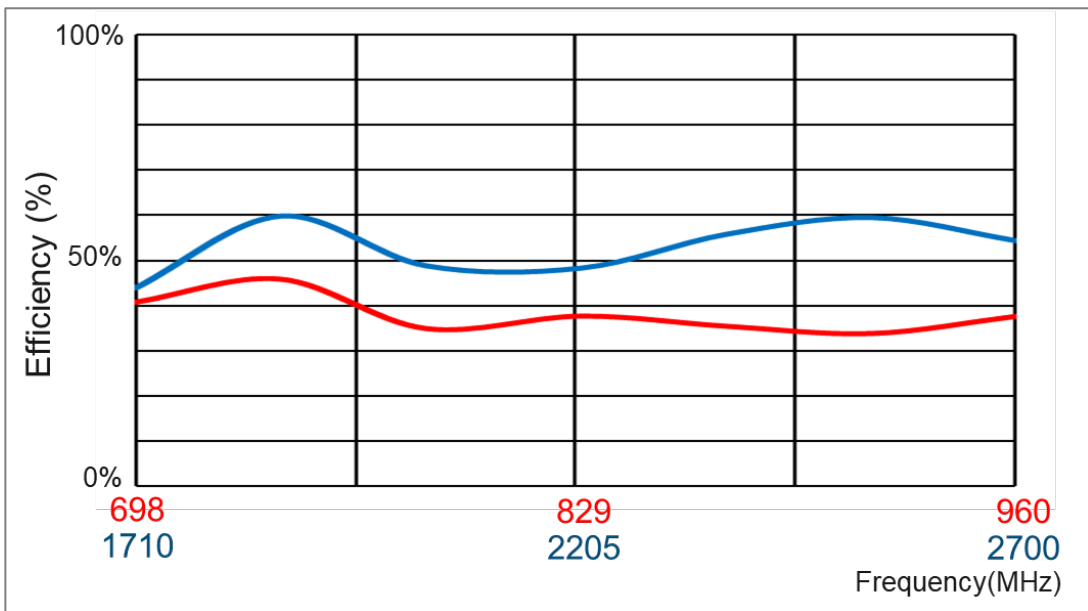

Data measured in free space and on plastic device enclosure

# RADIATION PATTERN

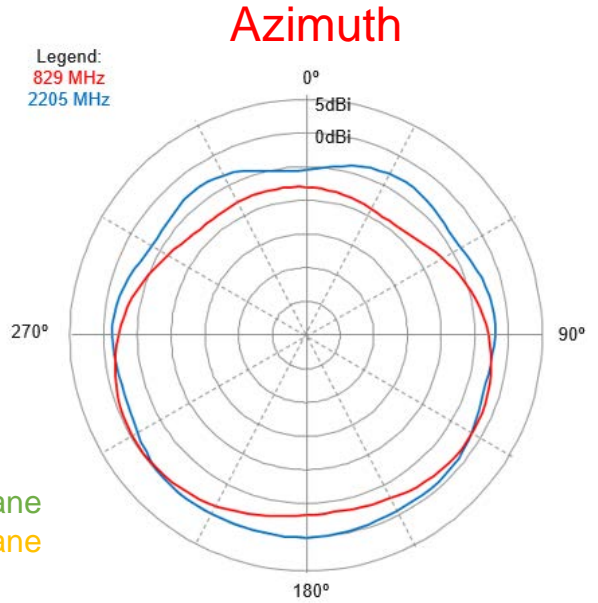
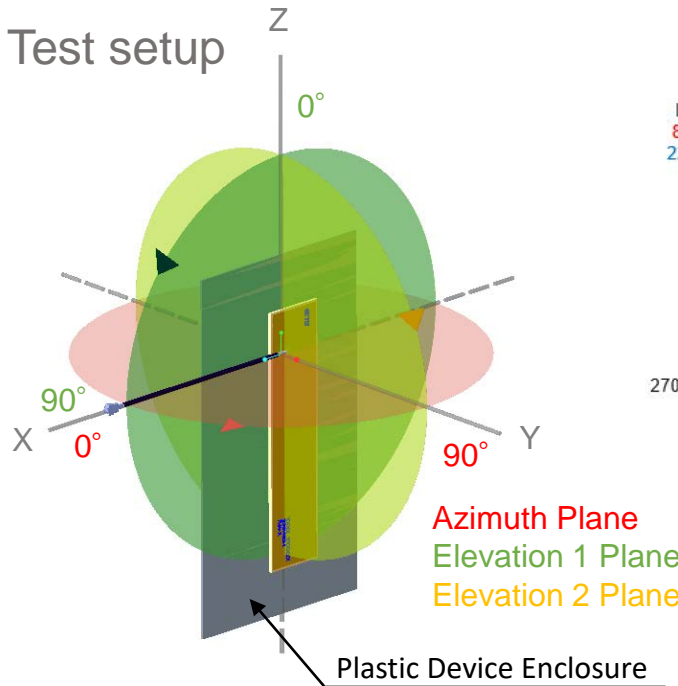

## Elevation 1

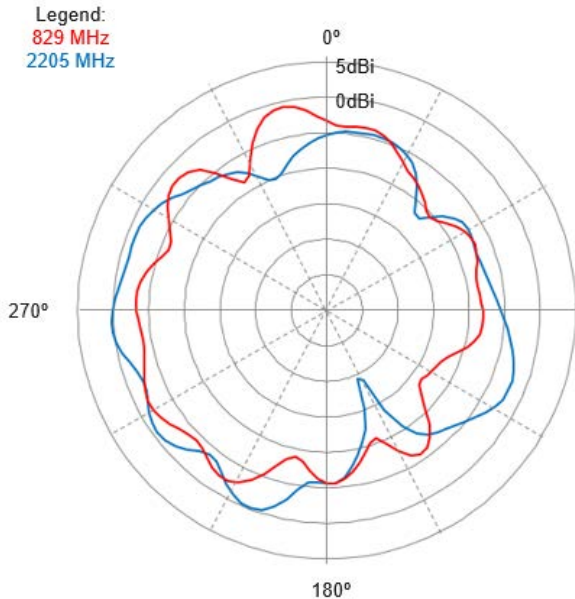

## Elevation 2

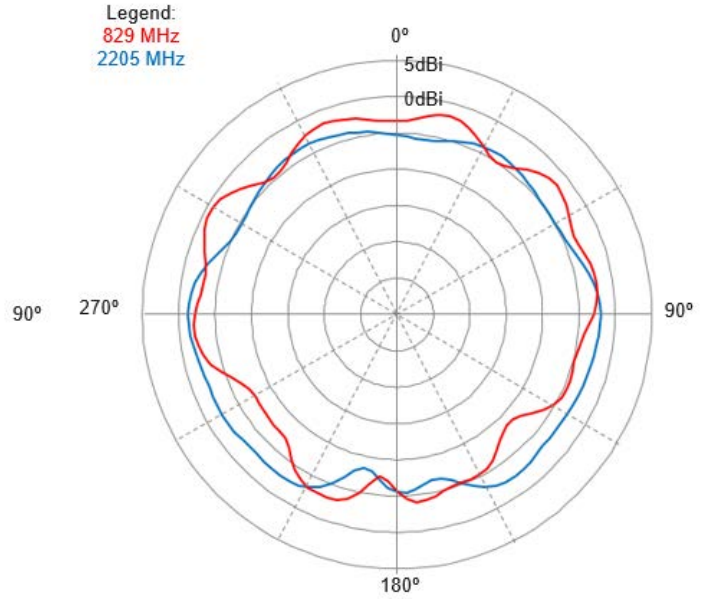

Data measured in free space and on plastic device enclosure

## KEEP OUT AREA

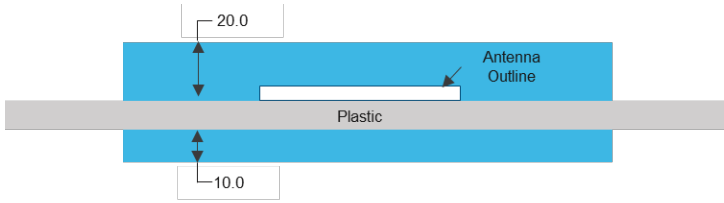

### NOTES

1. Antenna designed to be mounted on plastic cover.
2. Area in blue indicates Keep Out Area.
3. For more information please call TE.

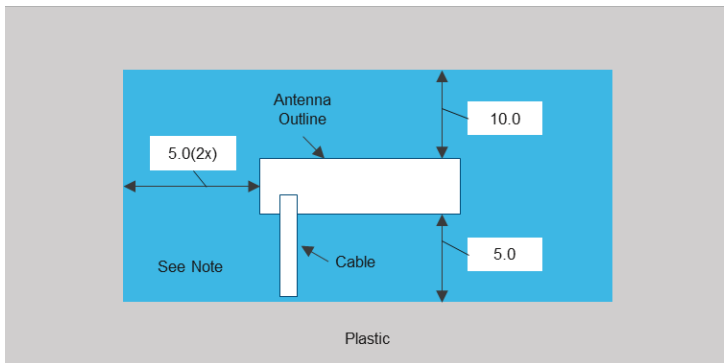

Dimension: mm

Diagram is not to scale

## DIMENSIONS

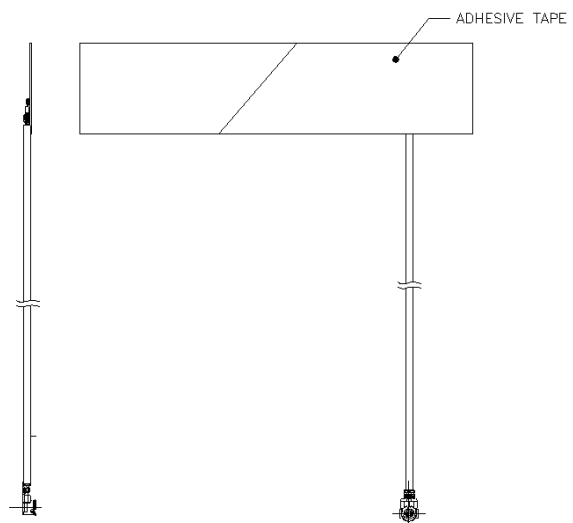
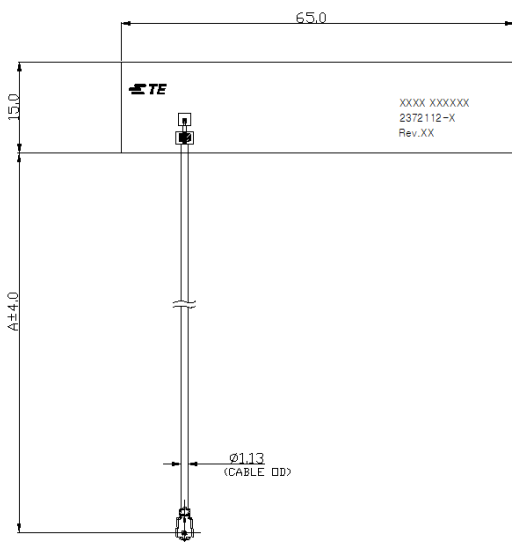

(Refer to Page 5 for dimension "A")



Dimensions: mm

Diagram is not to scale

## MATING COMPONENTS TO PART NUMBER AND DIMENSIONS

2372112-1	150	5.91	1.13	MHF-TYPE PLUG	RECEPTACLE (TE PN: 2337019-1)	
2372112-2	100	3.94	1.13	MHF-TYPE PLUG	RECEPTACLE (TE PN: 2337019-1)	
2372112-5	150	5.91	1.13	MHF4L-TYPE PLUG	RECEPTACLE (TE PN: 2334884-1)	
2372112-6	100	3.94	1.13	MHF4L-TYPE PLUG	RECEPTACLE (TE PN: 2334884-1)	
PART NUMBER	MM	INCH	CABLE (OD)	CONNECTOR TYPE (ON CABLE)	PART NUMBER	IMAGE
	CABLE LENGTH(A)		mm		MATING COMPONENTS	

## PACKAGING

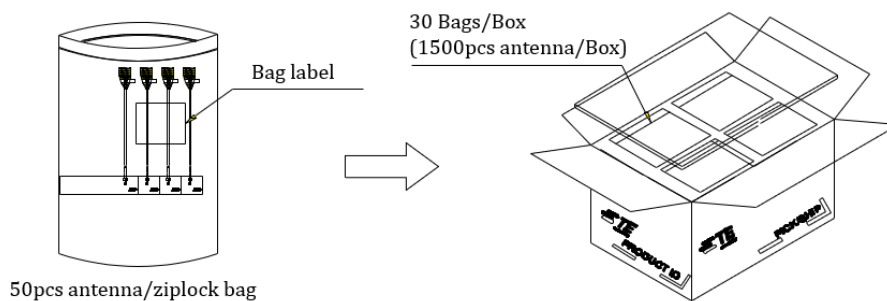

### TE TECHNICAL SUPPORT CENTER

USA: +1 (800) 522-6752  
 Canada: +1 (905) 475-6222  
 Mexico: +52 (0) 55-1106-0800  
 Latin/S. America: +54 (0) 11-4733-2200  
 Germany: +49 (0) 6251-133-1999  
 UK: +44 (0) 800-267666  
 France: +33 (0) 1-3420-8686  
 Netherlands: +31 (0) 73-6246-999  
 China: +86 (0) 400-820-6015

For phone numbers in other countries, go to [te.com/support-center](http://te.com/support-center)

### te.com

TE Connectivity, TE Connectivity (logo) are trademarks. All other logos, products and/or company names referred to herein might be trademarks of their respective owners.

The information given herein, including drawings, illustrations and schematics which are intended for illustration purposes only, is believed to be reliable. However, TE Connectivity makes no warranties as to its accuracy or completeness and disclaims any liability in connection with its use. TE Connectivity's obligations shall only be as set forth in TE Connectivity's Standard Terms and Conditions of Sale for this product and in no case will TE Connectivity be liable for any incidental, indirect or consequential damages arising out of the sale, resale, use or misuse of the product. Users of TE Connectivity products should make their own evaluation to determine the suitability of each such product for the specific application.

© 2020 TE Connectivity Ltd. family of companies All Rights Reserved.

01/2022

单击下面可查看定价，库存，交付和生命周期等信息

[>>TE Connectivity\(泰科\)](#)