

LOC		DIST		REVISIONS			
AD	00	P	LT#	DESCRIPTION	DATE	DWN	APVD
		B		REVISED PER ECO-11-025276	04JAN12	KH	DY

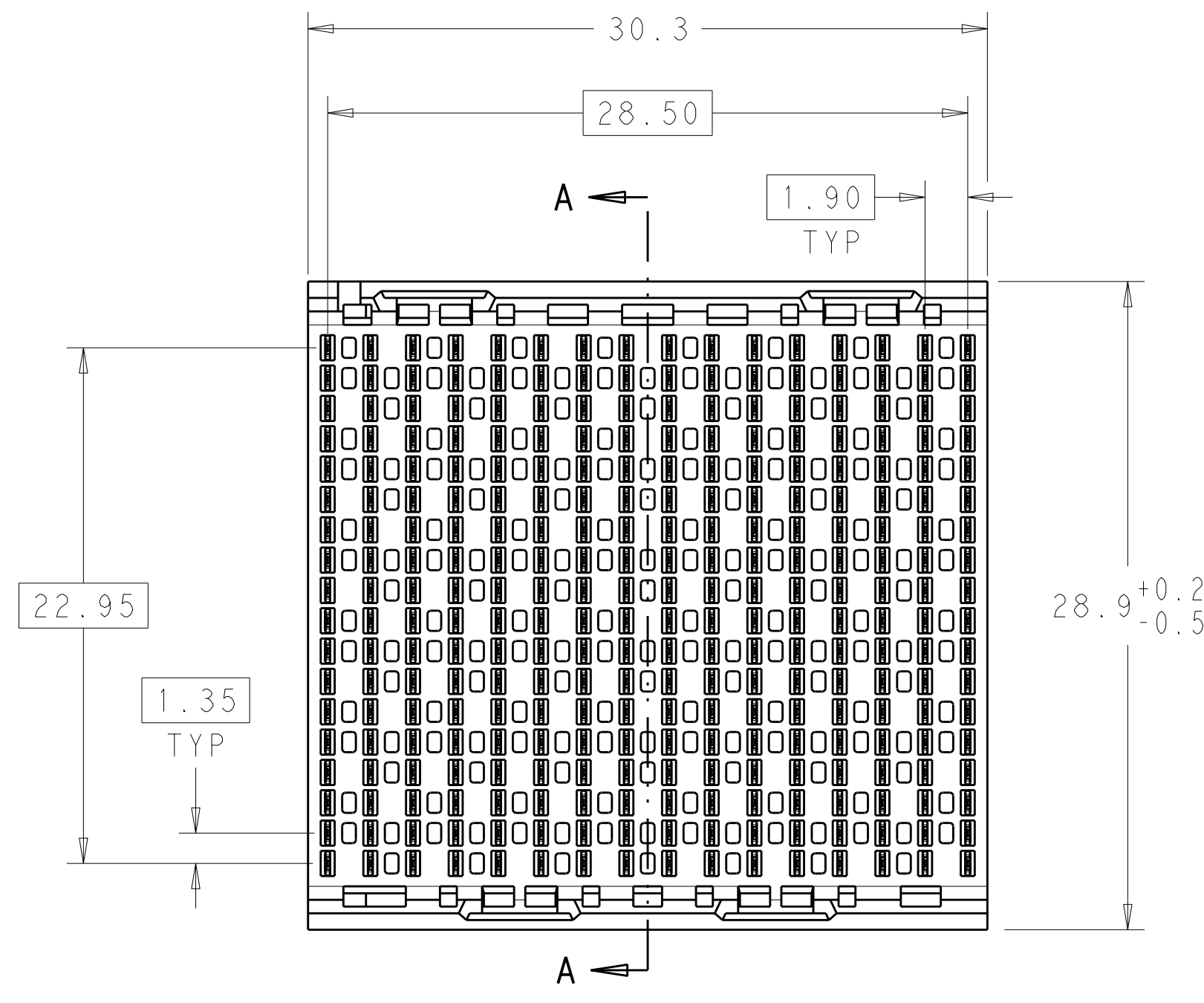

NOTCH DESIGNATES ROW A

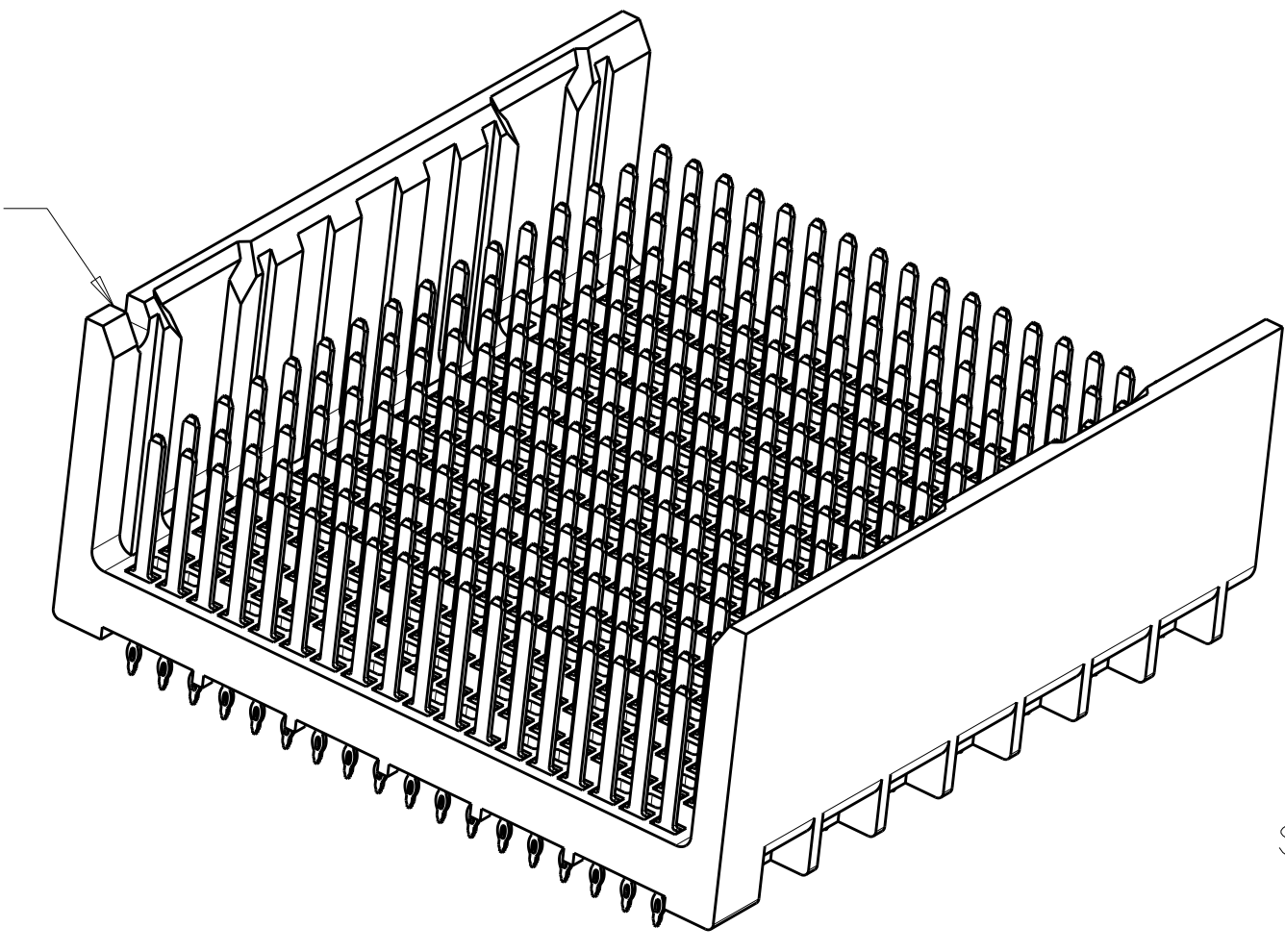

- 1 MATERIAL:
HOUSING: LCP, GLASS FILLED, UL94V-0.
TERMINALS: HIGH PERFORMANCE COPPER ALLOY.
- 2 FINISH:
30μ" MIN GOLD IN CONTACT AREA. SELECTIVE TIN ON PCB TAILS, NICKEL OVERALL.
- 3 FINISH:
30μ" MIN GOLD IN CONTACT AREA. SELECTIVE TIN-LEAD ON PCB TAILS, NICKEL OVERALL.

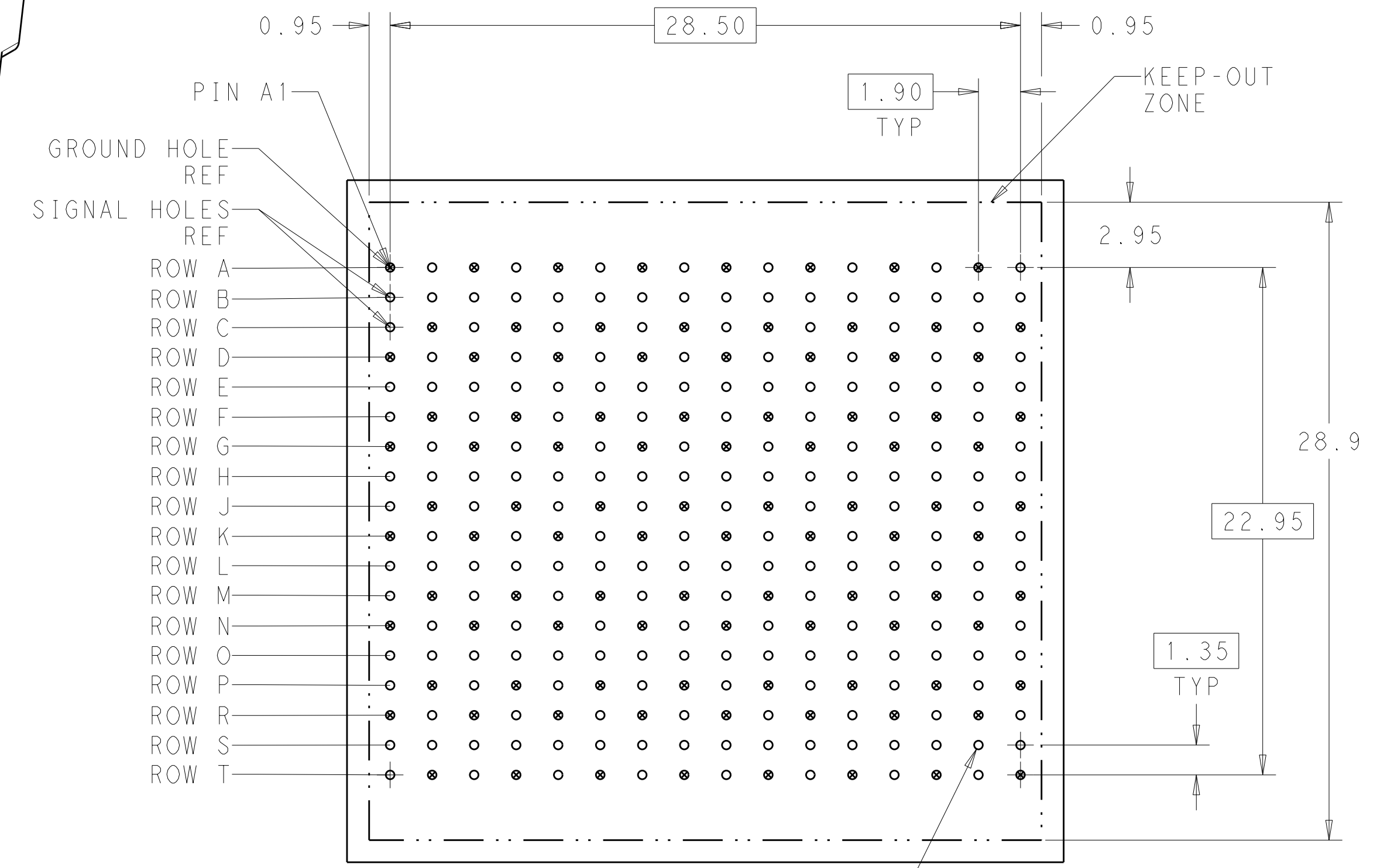

288X $\varnothing 0.39 \pm 0.05$
 $\varnothing 0.10$
 PLATED THRU HOLE

UNGUIDED BACKPLANE HOLE PATTERN (CONNECTOR SIDE)

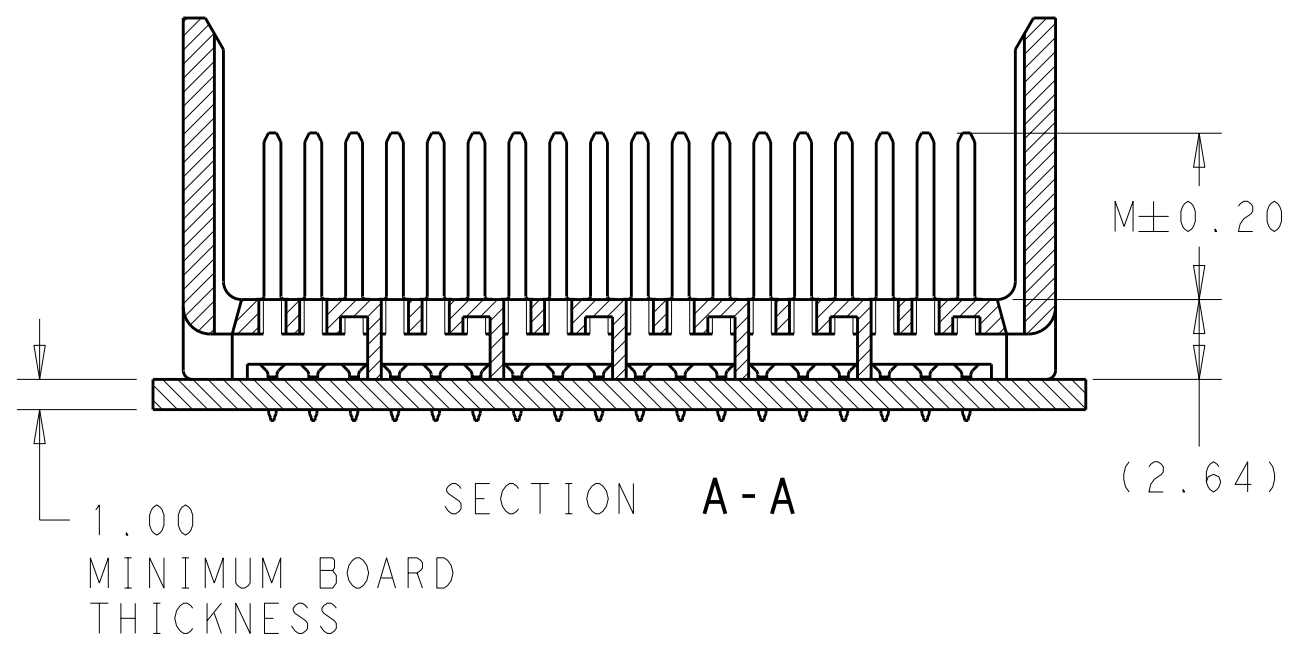
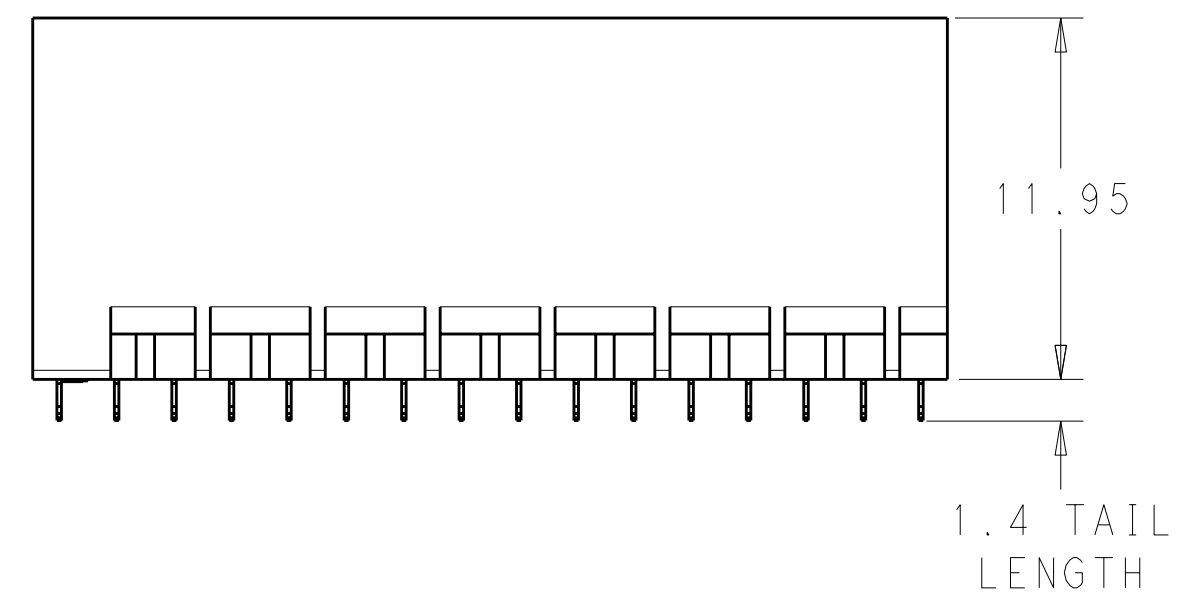

THIS DRAWING IS A CONTROLLED DOCUMENT.		DWN J. K. SHOBER 25JAN2011	TE Connectivity
DIMENSIONS: mm		CHK J. EABY 25JAN2011	
TOLERANCES UNLESS OTHERWISE SPECIFIED:		APVD J. EABY 25JAN2011	NAME
0 PLC ±	1 PLC ±0.25	PRODUCT SPEC	IMPACT, 6 PAIR, 16 COLUMN, HEADER
2 PLC ±0.13	3 PLC ±	APPLICATION SPEC	UNGUIDED, OPEN END WALL
4 PLC ±	ANGLES ±	WEIGHT	SIGNAL MODULE, 0.39 PTH
MATERIAL	FINISH SEE TABLE	SIZE CAGE CODE DRAWING NO	RESTRICTED TO
		A100779C=2007900	
CUSTOMER DRAWING		SCALE 4:1	SHEET 1 OF 2 REV B

THIS DRAWING IS UNPUBLISHED. RELEASED FOR PUBLICATION 20
 © COPYRIGHT 20 . . . ALL RIGHTS RESERVED.

LOC	DIST	REVISIONS					
AD	00	P	LTB	DESCRIPTION	DATE	DWN	APVD
		-	-	SEE SHEET 1	-	-	-

\triangle_3	5.5	2007900-6
\triangle_3	4.9	2007900-5
\triangle_3	4.5	2007900-4
\triangle_2	5.5	2007900-3
\triangle_2	4.9	2007900-2
\triangle_2	4.5	2007900-1
FINISH	DIM M	PART NUMBER

REFER TO WWW.TE.COM
FOR PRODUCT AVAILABILITY

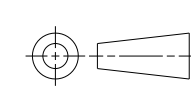
THIS DRAWING IS A CONTROLLED DOCUMENT.		DWN J. K. SHOBER 25JAN2011	 TE Connectivity	
DIMENSIONS: mm		CHK J. EABY 25JAN2011		
		TOLERANCES UNLESS OTHERWISE SPECIFIED: 9 PLC ± .25 2 PLC ±0.13 5 PLC ± . 4 PLC ± . ANGLES ± . FINISH SEE TABLE		NAME IMPACT, 6 PAIR, 16 COLUMN, HEADER UNGUIDED, OPEN END WALL SIGNAL MODULE, 0.39 PTH
MATERIAL -		APVD J. EABY 25JAN2011 PRODUCT SPEC - APPLICATION SPEC - WEIGHT - CUSTOMER DRAWING		SIZE CAGE CODE DRAWING NO A100779C=2007900 RESTRICTED TO -
			SCALE 5:1	SHEET 2 OF 2
			REV B	

单击下面可查看定价，库存，交付和生命周期等信息

[>>TE Connectivity\(泰科\)](#)