

PRINT DIST
 単位: mm DIMENSIONS IN MM. DO NOT SCALE PRINT
 METRIC
 NUMBER C-175266
 三角 (3rd ANGLE PROJECTION)

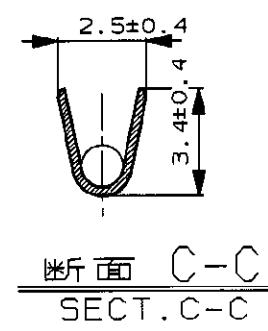
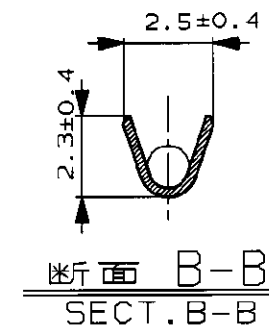
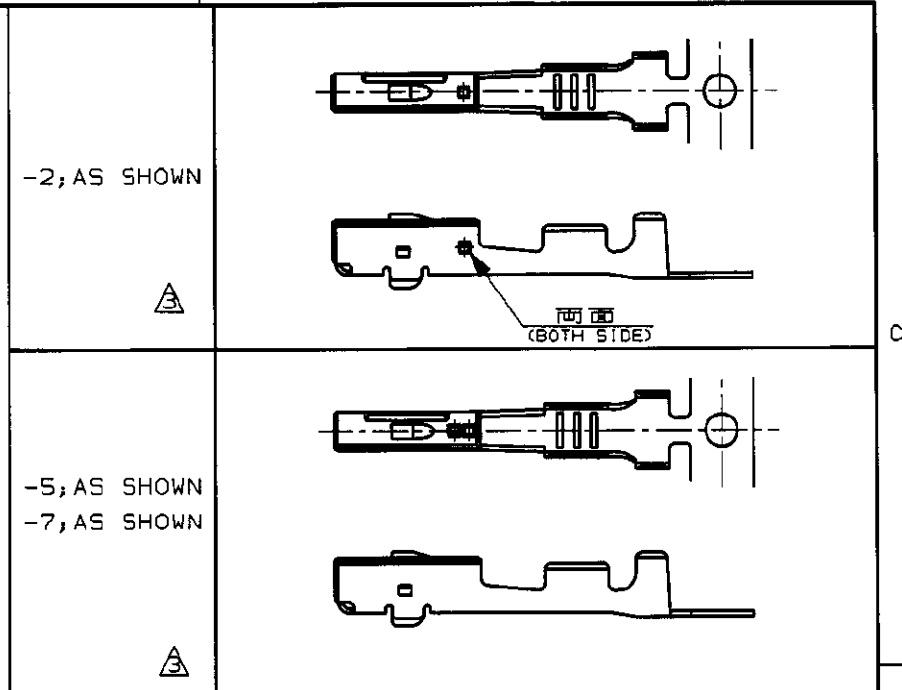
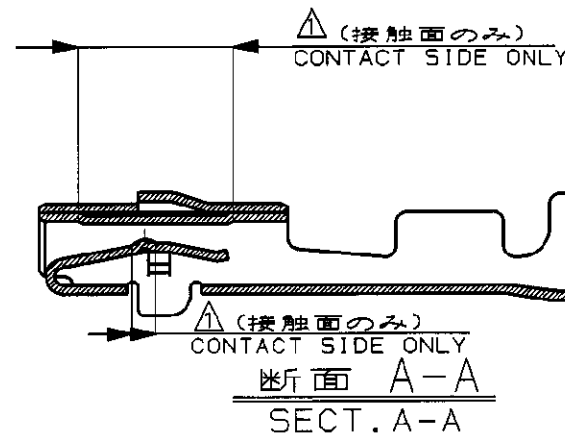
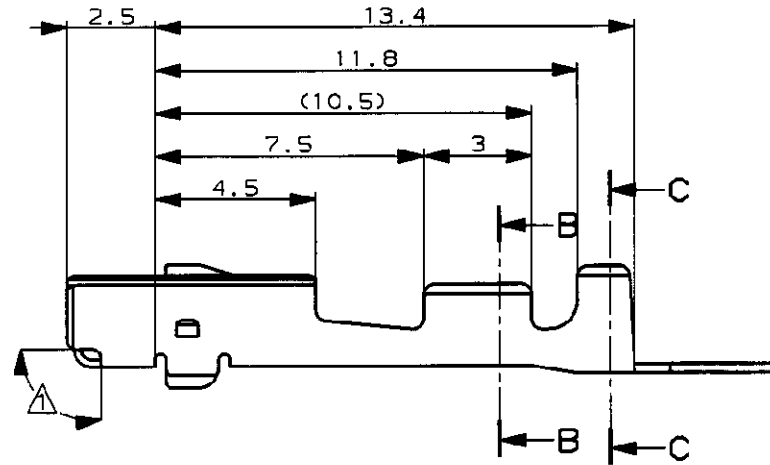
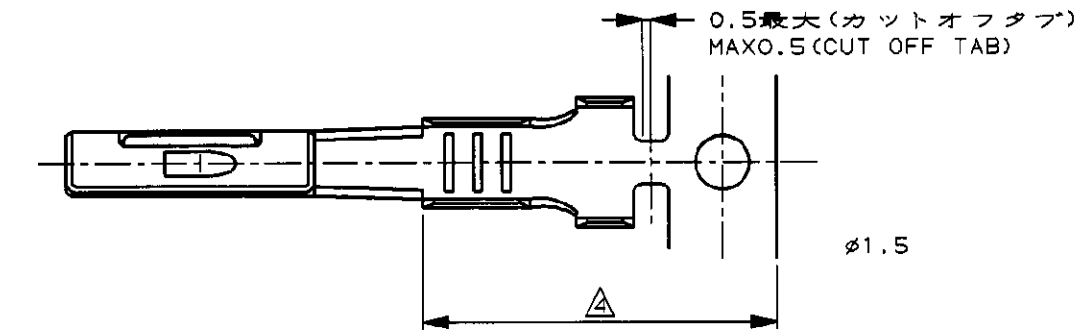
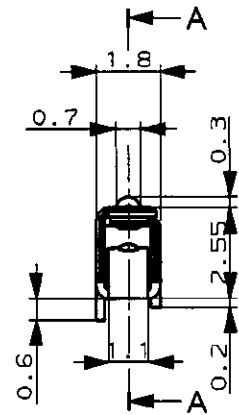

- NOTE ;
- △ SELECTIVE GOLD
 - 2. APPLICATION SPEC NO. 114-5159
 - △ THE STAMP DISCERN GOLD PLATING FROM TIN PLATING
 - △ SELECTIVE TIN

- 注 ;
- △ 部分金めつき
 - 2. 取付通用規格番号 114-5159
 - △ 金めつき識別用刻印
 - △ バレルすずめつき

| | | | | |
|-----|------------------------|----|-----|----------|
| L | REVISED (FJ00-1220-99) | KS | MT | 15JUL 99 |
| K | 改訂 (FJ00-0577-98) | TK | NS | 25MAR 98 |
| J | 改訂 (FJ00-1031-97) | HY | NS | 29AUG 97 |
| H | 改訂 (FJ00-1905-95) | TS | KA | 2/22 95 |
| G | 改訂 (FJ00-1472-94) | TS | KA | 2/22 95 |
| F | 改訂 (FJ00-0975-94) | TS | KO | 8/2 94 |
| E | 改訂 (FJ00-0097-94) | TS | KO | 6/14 94 |
| D | 改訂 (FJ00-0153-94) | TK | MT | 4/3 94 |
| C | 改訂 FJ00-0051-93 | YK | KO | 2/4 93 |
| B | 改訂 J-0212 | KO | SI | 7/8 91 |
| A | 再作成 | KO | SI | 4/25 91 |
| LTR | 変更 (REVISION RECORD) | DR | CHK | DATE |

| | | | |
|------------------------------------------------------------------------------|----------------------------------|-------------------------------------------------------|---------------------|
| 0.76μm以上 | — | 部分金めつき (SELECTIVE GOLD) バレルすずめつき (SELECTIVE TIN) | 175266-7 |
| 0.76μm以上 | — | 部分金めつき (SELECTIVE GOLD) | 175266-5 |
| 0.38μm以上 | 179418-2 | 部分金めつき (SELECTIVE GOLD) | 175266-2 |
| 金めつき厚 (GOLD PLATING THICKNESS) | バラ端子型番 (LOOSE PIECE CONTACT P/N) | 仕上げ (FINISH) | AMP型番 (PART NUMBER) |
| Copyright ©1990年 AMP (Japan) LTD. 日本エー・エム・ビー株式会社 | | Copyright ©1990 AMP (Japan) LTD. ALL RIGHTS RESERVED. | |
| Wire Range: 0.37-0.88 mm ² (AWG #22-#18) | | Insulation Dia.: 1.1-2.1 mmφ | |
| Material (MATERIAL): KLF-5 | | Finish (FINISH): SEE TABLE | |
| DR. K. Oda 4/25'91 | | DE. K. Oda 4/25'91 | |
| CHK. # | | APP. 4/25'91 | |
| 名称 (NAME) .040 II SERIES S RECEPTACLE CONTACT .040 II シリーズ S リセプタクル コンタクト | | | |
| 一般公差 (GENERAL TOLERANCE) | | LDC 番号 (No.) | |
| 10以下: ±0.2 10を超え 30以下: ±0.25 30を超え 100以下: ±0.3 角: ±3° | | B J C-175266 | |
| 尺度 (SCALE) 5-1 | | REV. L SHEET 1 OF 1 | |

单击下面可查看定价，库存，交付和生命周期等信息

[>>TE Connectivity\(泰科\)](#)