



Dynamic Series Connectors





2020 Edition

RoHS
Ready 

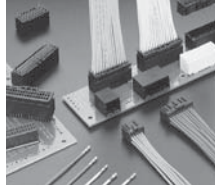
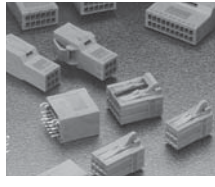

DYNAMIC SERIES CONNECTORS

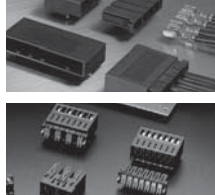
List of the Dynamic series

Series Name				Mechanical performance											
Series	Family images	Spec.Name	Description	Wire-to-Wire	Mounting Methods								Board to Board	Number of Positions	
					Wire-to-board				Panel Mount	DIN Rai	Tap	Wire			Drawer
					DIP		SMT								
Vertical type	Horizontal type	Vertical type	Horizontal type												
1000 (P.10 - 25)		1100S	Standard	-	-	0	-	-	-	-	-	-	-	-	4,8,10
		1100D	Standard	0	0	0	0	-	0	-	-	-	-	-	10,20,22,26,28,30,32,34,40
		1200S	High Voltage	0	0	-	-	-	-	-	-	-	-	-	2
		1200D	High Voltage	0	0	0	-	-	0	-	-	-	-	-	4,6,8,10,12,16,20
		1500T	Module Type	-	0	0	-	-	0	0	-	0	-	-	3,6,9,10,12,34,36
		1900D	Spring Clamp Type	-	0	0	-	-	-	-	-	-	-	-	8,12,22,30,38
2000 (P.26-34, P.60-67, P.95-97)		2100S	Standard	0	0	0	-	-	0	-	-	-	-	-	3
		2100D	Standard	0	0	0	-	-	0	-	-	-	-	-	6,8,12,16,20
		2100M	Multiposition Drawer	0	-	0	-	-	0	-	-	-	0	-	50
		2600D	Hybrid Power/Signal	-	0	-	-	-	-	-	-	-	-	-	48
		2800	Multi-Frame	0	-	-	-	-	0	-	-	-	-	-	30
		2950	Spring Clamp Type	-	-	0	-	-	-	-	-	-	-	-	5,6
		2970	On-Site Push-In Type	-	-	-	-	0	-	-	-	-	-	-	3,4
3000 (P.35-70, P.95-97)		3100S	Standard & SMT	0	0	0	0	0	0	-	-	-	-	-	3,4,5,6,8,10
		3100D	Standard	0	0	0	-	-	0	-	-	-	-	-	6,8,10,12,16,20
		3100M	Module Type	-	0	0	-	-	-	-	-	-	-	-	6
		3200S	High Voltage	0	0	0	-	-	0	-	-	-	-	-	2,3,4,5,6
		3200M	High Voltage	0	0	0	-	-	0	-	-	-	0	-	6,10,12,20
		3200FMLB	Sequential type	-	-	0	-	-	-	-	-	-	-	-	4,12
		3200T	High Voltage	-	-	0	-	-	-	-	-	-	-	-	9
		3400F	Skyscraper	-	-	0	-	-	-	-	-	-	-	-	12,20
		3500D	Modular Type	0	0	0	-	-	0	-	-	-	-	-	2,4,6,12,20
		3800	Multi-Frame	0	-	-	-	-	0	-	-	-	-	-	12
		3100/3200	Dynatap	-	-	-	-	-	-	-	0	-	-	-	18,24
3950	Spring Clamp Type	-	-	0	-	-	-	-	-	-	-	-	2,3,4,6,7,8,11		
4000 (P.71-77, P.60-64, P.95-97)		4200S	Standard	0	0	0	-	-	0	-	-	-	-	-	2,3,4
		4200M	Module Type	0	-	-	-	-	0	-	-	-	-	-	6
		4800	Multi-Frame	0	-	-	-	-	0	-	-	-	-	-	8
		4950	Spring Clamp Type	-	-	0	-	-	-	-	-	-	-	-	8
5000 (P.78-97)		5200S	Standard	0	0	0	-	-	0	-	-	-	-	-	2,3,4,6
		5200M	High Voltage	0	0	0	-	-	0	-	-	-	-	-	4,6,8
		5300S	Reversed Housing	-	-	-	-	-	0	-	-	-	-	-	3
		5300D	Reversed Housing	-	-	-	-	-	0	-	-	-	-	-	4
		5200	Dynatap	-	-	-	-	-	-	0	0	-	-	-	12,20
			Dyna-Clamp kit	0	0	0	-	-	0	-	-	-	-	-	3,4
		D5200Mα	High Current	-	-	0	-	-	-	-	-	-	-	-	4
		DZ-5200	Board-to-Board type	-	-	-	-	-	-	-	-	-	-	0	5,7
				-	-	-	-	-	-	-	-	-	0	-	3,4
5800	Multi-Frame	0	-	-	-	-	0	-	-	-	-	-	4		
7000 (P.98-103)		7100	Standard	0	-	0	-	-	0	-	-	-	-	4	
		7300	Reversed Housing	0	-	0	-	-	0	-	-	-	-	4	
			Dyna-Clamp kit	0	-	-	-	-	-	-	-	-	-	4	
Other products			Multiple Enclosure Connector						0					15,24,32	



			Electrical Performance				Safety Standards		Corresponding Pages
Number of Rows	Pitch (mm)	Wire Range (AWG)	Maximum rated current (A)	Maximum Rated voltage (V)	Withstanding Voltage (V)	Durability (Cycles)	UL CSA TÜV	IP Level	
1	2.0	30-22	3	125	700	Gold: 50 Tin: 30	UL : File No. E28476 CSA : Report No. LR7189 TÜV : License No. R50085096		14
2	2.0	30 - 22	3	125	700				15 - 17
1	2.5	30 - 18	5	250	1100				18
2									19 - 21
3,4	3.5								22 - 24
2	3.5	24 - 18	4	150	1100	UL 1059 E60677		25	
1	2.5	28 - 18	5	250	1500	500	UL : File No. E28476 CSA : Report No. LR7189 TÜV : License No. R9950679		30
2									31 - 32
2		20	2.6	250	500	500	UL : File No. E28476 CSA : Report No. LR7189 TÜV : License No. R9950679		33
3	D-2(2.5) D-3(3.81)	D-2(28 - 18) D-3(28 - 14)	D-2(3.2) D-3(7.5)						34
6	3.75	28 - 18	5						95-97
1	5.08	18 - 14	10	600	2200	Gold: 500	UL : 1059		60-62
1	5.0	24 - 14	10(UL)/20(IEC)	300(UL)/400(IEC)	2210	Gold: 100; tin: 25	UL:1059 IEC:61984/90647-7-1		65-67
1	3.81	28 - 14	15	250	1500	Gold: 500 Tin: 100	UL : File No. E28476 CSA : Report No. LR7189 TÜV : License No. R50084673 (VDE0627)		40-43
2	3.81								44-45
2	3.81								46
1	5.08			47-49					
2	5.08			50-54					
2	5.08			55					
3	5.08			56					
4	3.81			57					
2	5.08			58-59					
4	6.5			95-97					
3,6	3.81			28 - 14	15				250
1,2	7.5	22-14	14.5	600	2200	Gold: 500	UL : 1059		63
1	6.35	16 - 12	24	600	2500	25	UL : File No. E28476 CSA : Report No. LR7189 TÜV : License No. R50084673		75-76
2	6.35		24	600	2500				77
4	6.35		24	600	2500				95-97
1	7.5	16 - 10	22	600	3310	Gold: 500	UL : 1059		64
1	10.16	16 - 10	30	630	3000	0.76µ gold: 50 0.38µ gold: 25	UL : File No. E28476 CSA : Report No. LR7189 TÜV : License No. R9650368		10
2									10
1									20
2		20	86						
3			87						
1			0.76µ gold: 50 0.38µ gold: 25						88-89
2		20 - 8	45			Silver: 25	UL : File No. E28476 CSA : Report No. LR7189 TÜV : License No. R9650368	10	90-91
1	5.08	-	20	250	2200	15	UL : File No. E28476 CSA : Report No. LR7189 TÜV : License No. R50073218		92-93
	10.16		30	600	4000				
2	12.0	16 - 10	30	630	3000	0.76µ gold: 50 0.38µ gold: 25	UL : File No. E28476 CSA : Report No. LR7189	10	95-97
2	16	16 - 6	60 (board-to-wire) 65 (wire-to-wire) 55 (wire-to-wire cable clamp type)	630	3000	0.76µ gold: 20	UL : File No. E28476 TÜV : License No. R9650368	20	101
2	16	16 - 6							102
2	16	-							103
4,8	See details in series page		See details in series page				See details in series page		104-106



Contact Features (Example of the D-3000 Series)

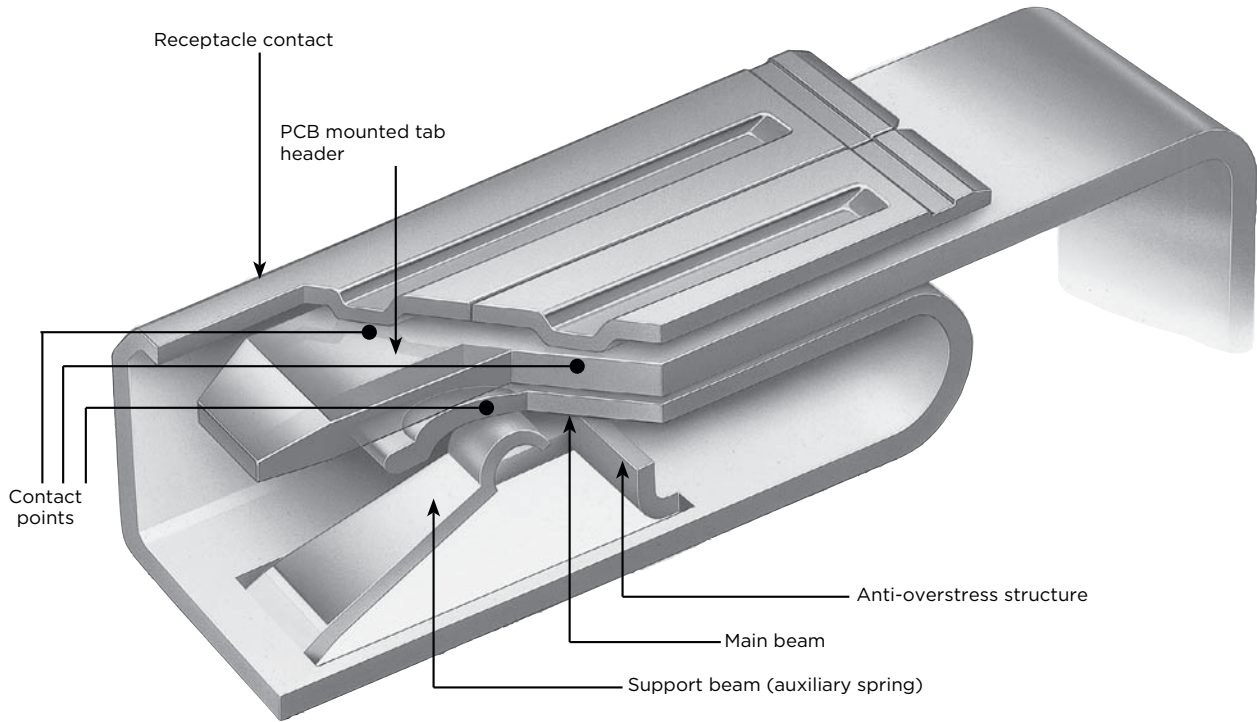

(Illustration of the D-3 Connector)

Contact Pressure Adjustment Method

- Gold and Tin contacts are available. Adjustable gaps for the auxiliary spring (at positions of A-C) to get the optimum contact pressure. For gold-plated product, both high pressure contact and standard pressure contact are available in accordance with the intended use
- Anti-overstress structure prevents damage to the main beam which might be caused by insertion of external objects or twisting (Receptacle contact type of D-2 S, M/D-3 S, M, L, 2L, 3L/D-5 S, M)

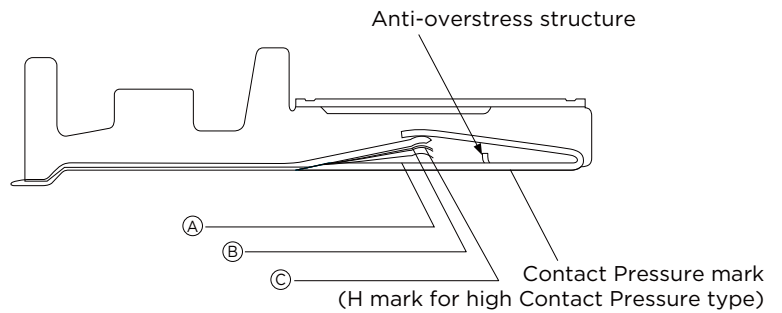

(Applicable to the D-3 terminal)

Plating	Type	Contact Pressure	Position	Contact Pressure Mark	Applicable Positions	Specifications	Application	Durability (cycles)
Gold	Standard Contact Pressure	Around 1.47N	(A)	—	1-100	Standard	Used for signal/power multi-position and High durability cycles circuits	500
	High Contact Pressure	Around 2.45N	(B)	H	1-20	Vibration / High current	Used for signal/Power supply/ Motor application with high-vibration feature	500
Tin	High Contact Pressure	Around 3.92N	(C)	H	1-10	High Current	Used for Signal/Power supply circuit with few durability cycles	100

Contact Features (Example of the D-3000 Series)

Tab/Receptacle Contact

Male side is tab, while female side is receptacle contact so as to avoid twisting. (Refer to Figure below) Highly reliable 3-point contacts are used.

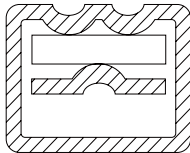

Fixing of the contact and housing

The housing lance is used to secure the contact in place. The lance ensures the contact stays secure in the housing and helps prevent damage during contact mating. In addition to these protective features, the housing lance produces an audible “click” ensuring the contact is securely locked in the housing. The contact can still be easily removed with extraction tool.

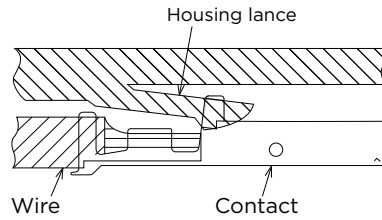

Confirmation Marks

- Contact Pressure marks.....“H” mark on the bottom of the contact for high pressure contact product (standard pressure contact for those without the marks)
(Only for D-3 connector)

- Plating marks.....To show clearly types and thickness of the plating. Following numbers will be marked on the side surface of the contact. This number is consistent with the additional number of contact’s part model number.

- 2.....Gold plating of 0.38µm in thickness
- 3.....Gold plating of 0.76µm in thickness
- 5.....Tin plating

- Marking both contact series (D-1/D-2/D-3/D-4/D-5) and wire range (SS,S,M,L) on side surface of contact aim to avoid misuse of hand tools and extraction tools.

Wire range marks

D-1	SAWG#30-28
	MAWG#28-22
	LAWG#28-22
	2LAWG#22-18
D-2	SAWG#28-24
	MAWG#22-18
D-3	SAWG#28-24
	MAWG#24-20
	LAWG#20-16
	2LAWG#16-14
	3LAWG#16-14
D-4	MAWG#16-14
	LAWG#14-12
D-5/D5α	SSAWG#20-16
	SAWG#16-14
	MAWG#12-10
	LAWG#8

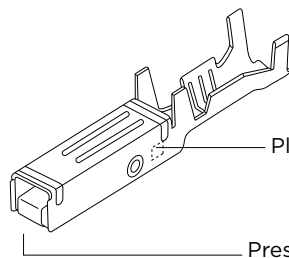

Receptacle Contact

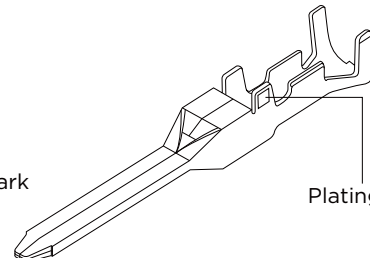

Tab contact

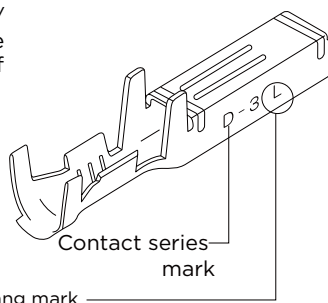

Receptacle Contact

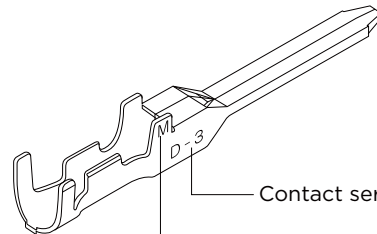

Tab contact

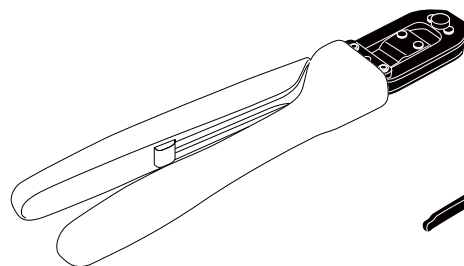

Hand tool

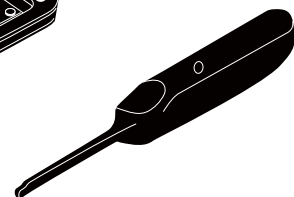

Extraction

Housing Features (Example of the D-3000 Series)

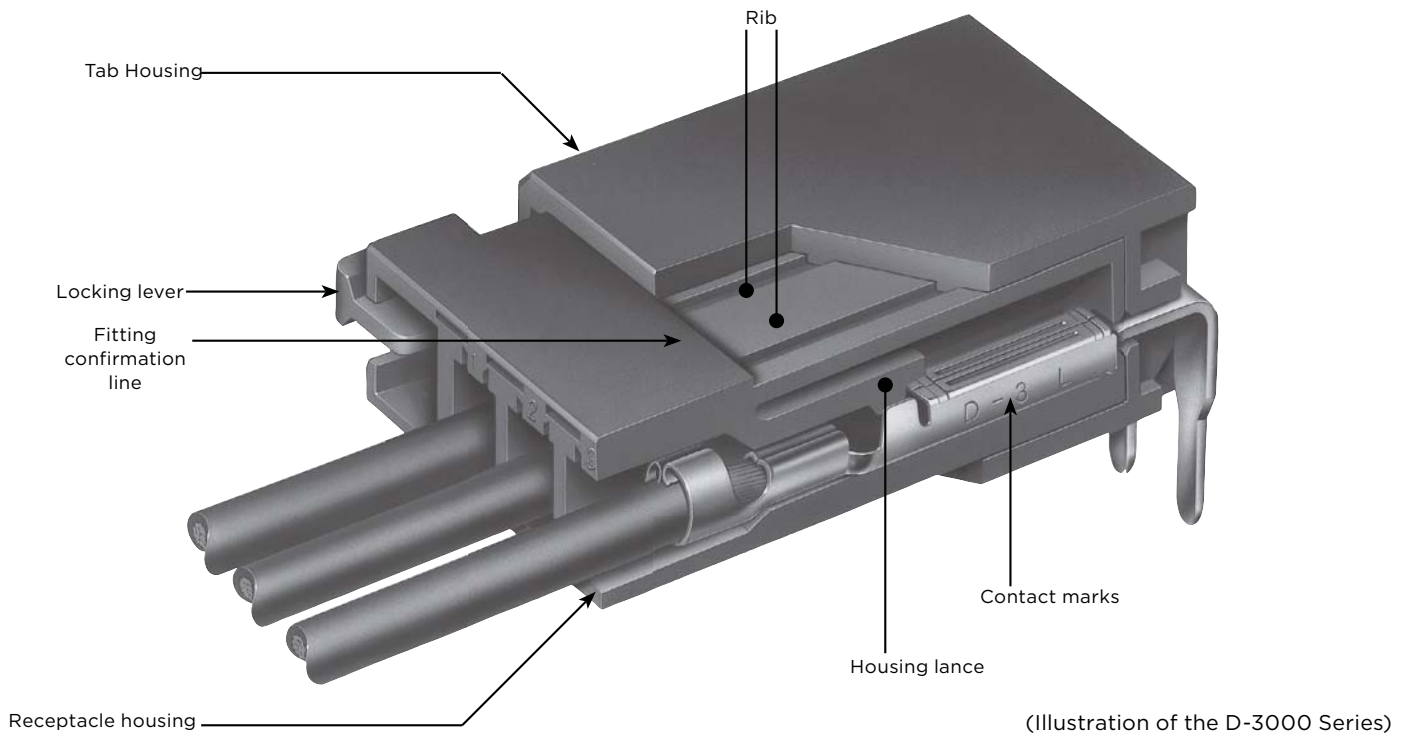

Easy to insert and extract the connector

- When you insert or extract the connector, a clear “click” sound will be heard. A fitting confirmation line is provided to confirm the operation
- Pinch 2 locking levers on both sides of the housing to easily extract the receptacle side (D -3100/D-3200/ D-4000/D-5200 Series)

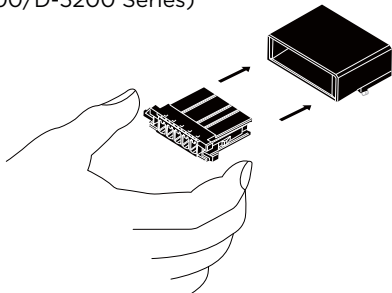

- For safety consideration, well rounded corners will be used to prevent hand injuries when inserting or extracting the connector

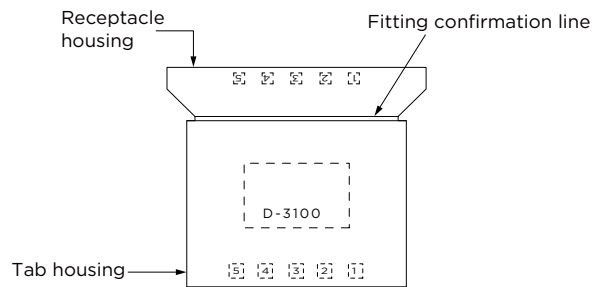

Vertical - type header

- To avoid mis-installation or mis-alignment of the Header on board, pay attention to direction indicator (Concave) of Vertical-type header (only available for D-3000 Series)

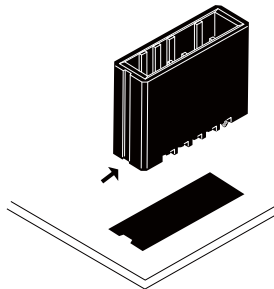

Housing to protect Tin-plated contacts

- For protecting the soldering Tin-plated contacts, Housing of horizontal type of Header will be fully applied to cover contacts.

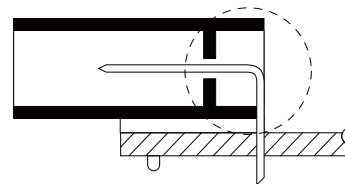

Housing Features (Example of the D-3000 Series)

Retention legs for board mounting

- For robotic automatic implementation, the retention legs will be provided for both the vertical-type and the horizontal-type headers.

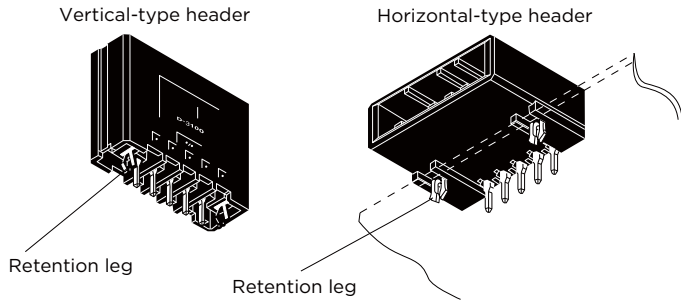

Note: The fixing pins are of the same thickness as the 1.6mm thickness circuit board. When they are used for a 2.4mm thickness circuit board, the strength will decrease somewhat.

- Especially for the horizontal-type header, it is possible to mount to the bottom of the housing and it will not take up as wide a space as the conventional system. Retention legs are close to the insertion part of the receptacle housing so as to resist tilting caused by the cable (Patent number 2,508,076).

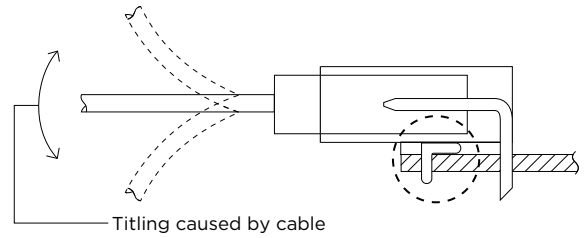

Twisting Prevention Structure

- The ribs are used in both receptacle housing and tab housing. This safety design can be used to avoid any backlashes between housings after the receptacle housing has been completely inserted into tab housing.

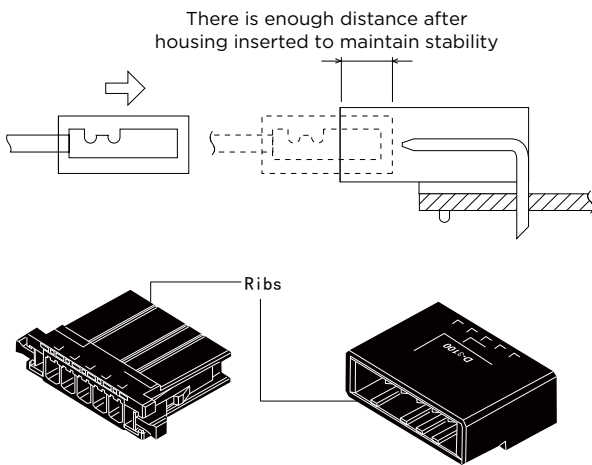

Anti-mis-plugging structure

- Part of the products (D-1200D/ D-2100/ D-2100D/ D-3100/ D-3100M/ D-3200/ D-3200M/D-3200T/ D-4000/ D-5200/ D-5200M) is provided with keying to prevent incorrect insertion. By using this plug, it also makes it easier to prevent incorrect insertion of other items. (refer to page 107, which shows the information of keying plugs)

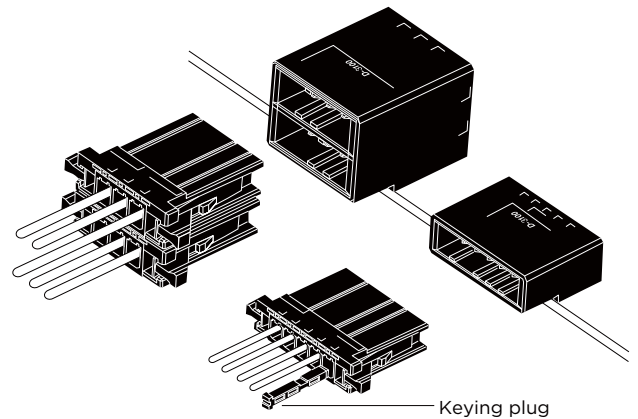

Label Mark

- A flat side portion is provided in the housing for custom labels.

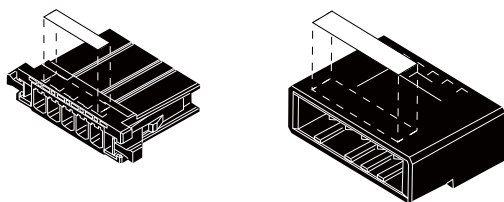

Easy-to-read circuit number

- To facilitate cable assembly, tab and receptacle housings will be marked with circuit numbers.

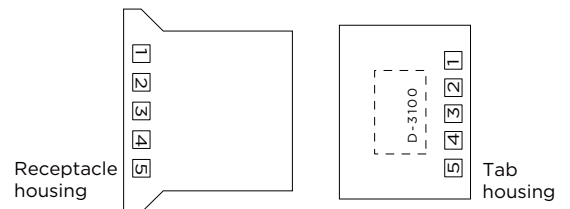

Guideline for plating selection(These guidelines apply to the D-3000 series only. Please note that they may not be suitable for other products.)

Whether to use gold or tin plating depends on the voltage, current, environment (vibration, temperature, gas, etc.), number of contact positions, and other variables.

Gold plating is recommended for general industrial machinery, but in reality cost considerations are also a factor. To help in this selection, these guidelines have been put together for Dynamic Series as a reference in the selection process.

(1) Selection based on voltage and current

	Gold Plated	Undetermined zone	Tin	No Plating (Reference)
Voltage	Below 3 V	3 to 30 V	30 - 100 V	Over 100 V
Current	Below 1 A	1 to 10 A	Over 10 A	Over 0.1 A

(Table 1)

Table 1 shows us that gold should always be used for applications under 3 volts and 1 ampere. When the voltage is over 30 and amperage is over 10, tin plating can be used. The most difficult area to make a selection is in the undetermined zone. In this zone either gold or tin plating can be used, and environmental parameters are the key variation to consider

due to extensive impact on the application.

In a clean environment tin plating is acceptable. However, use gold plating if the environment is harsh, such as high heat or humidity, the presence of gas is possible, vibration is extreme, mating and demating are frequent, or other factors.

(2) Selection based on number of contact positions (selection based on contact pressure)

Selecting based on the number of contact positions is often forgotten. The higher the contact pressure the more possible it is to use tin plating or no plating, regardless of the voltage or current mentioned in section 1. However, if pressure is too high, mating and demating become impossible so the connector function is lost. To get around this, we can drive the voltage and current down into a workable zone, but then we run into the problem of oxidation. To prevent oxidation, we use tin (approximately 2.94 N optimum contact pressure) or gold (approximately 1.18 N) plating. Even though, the contact pressure increases proportionally as we increase the number of contact positions, which causing difficult mating and demating. Generally speaking, given a 39.2 N limit for mating/demating by hand, it becomes difficult without using leverage,

such as a lever or jack screw when exceed the limit.

The Dynamic D-3000 series has a maximum of 20 contact positions. The contact pressure per pin with tin plating is 3.92 N, and with gold plating is 2.45 N and 1.47 N (high pressure types and standard types are available for some applications).

For instance, given 3.92 N for tin plating, the insertion and extraction force of 20-position connector will be 58.8N and 49.0N, which is difficult because it exceeds the range for barehanded work. Therefore, gold plating are selected when position increased regardless of the voltage and current conditions mentioned in section 1.

Table 2 shows the applicable maximum number of contact positions as a reference.

Contact Pressure	Applicable Maximum Number of Contact Positions
(1)Gold Standard contact pressure parts: 1.47N	20
(2)Gold High contact pressure parts: 2.45N	20
(3)Tin High contact pressure parts: 3.92N	12

(Table - 2) Note: Insertion force and extraction force are not the same as contact pressure.

(3) Environment (vibration, humidity, gas, etc.)

Although the environment was discussed in section 1 about voltage and current, it is summarized again here. Use gold plating in a harsh environment, particularly for high vibration or heat, the presence of gas or other harsh conditions. Gold is a noble metal and does not react easily with other materials which means good resistance to oxidation. This is a very important property for contacts.

Also, if vibration is an issue, there is the risk of fretting corrosion (micro-abrasion). Gold plating is always the recommended choice.



Guideline for plating selection (These guidelines apply to the D-3000 series only. Please note that they may not be suitable for other products.)

(4) Others considerations

- Contact between dissimilar metals

Strongly recommend to match contacts with same plating materials. For example, gold-plated receptacle contact mate with gold-plated tab contact or header. That's because different plating materials may create a lot of ionization and electrolytes which lead to corrosion, therefore the performance of product will be worse than a pair of connectors with same plating.

- Being consistent within an application

We recommend that, as much as possible, the same type of plating be used within one application. This is to prevent connections being made between dissimilar metals, gold and tin as mentioned on the left, during assembly and maintenance. And for the same reason, we recommend using the same plating in factories or workplaces where assembly or harness production is done.

The above information has been summarized in "Plating selection at a glance" for your convenience.

- ★★★★ Best
- ★★ Good
- ★ Usable
- Unacceptable

Platings selection at a glance

Voltage/Current	Application	Tin plated	Gold Plated			
			0.38μ		0.76μ	
			Standard pressure	High pressure	Standard pressure	High pressure
Below 3V Below 1A	Standard specifications	-	★★	★★	★★★★	★★★★
	Vibration	-	★	★★	★	★★★★
	Harsh environment	-	★	★	★★	★★★★
	Extensive mating/ unmating	-	★★	★	★★★★	★★
	Many contact positions	-	★★★★	★★	★★★★	★★
3 to 30V 1 to 10A	Standard specifications	-	★★	★★	★★★★	★★★★
	Vibration	-	★	★★	★	★★★★
	Harsh environment	-	★★	★★	★★★★	★★★★
	Extensive mating/ unmating	-	★★	★	★★★★	★★
	Many contact positions	-	★★★★	★★	★★★★	★★
Over 3V Over 1A	Standard specifications	★★	★★★★	★★★★	★★★★	★★★★
	Vibration	-	★★	★★★★	★★	★★★★
	Harsh environment	-	★★	★★	★★★★	★★★★
	Extensive mating/ unmating	-	★★★★	★★	★★★★	★★
	Many contact positions	-	★★★★	★★	★★★★	★★

The above table is based on industrial equipment with sufficient margin reserved. There are various combinations depending on the application, so it is not necessarily as shown in the above table, which is for reference only.

D-1000 Series

Series introduction

D-1000 Series are the smallest connectors for signal lines among all the Dynamic connector series.

The Dynamic 1000 Series consists of 3 different pitch sizes: 2.0mm standard type, 2.5mm high-voltage type and 3.5mm type.

D-1000 Series has gold plated contacts to maintain its high reliability and also tin plated contacts for economical market needs. Customers can choose their own contacts according to specifications, applications and cost.

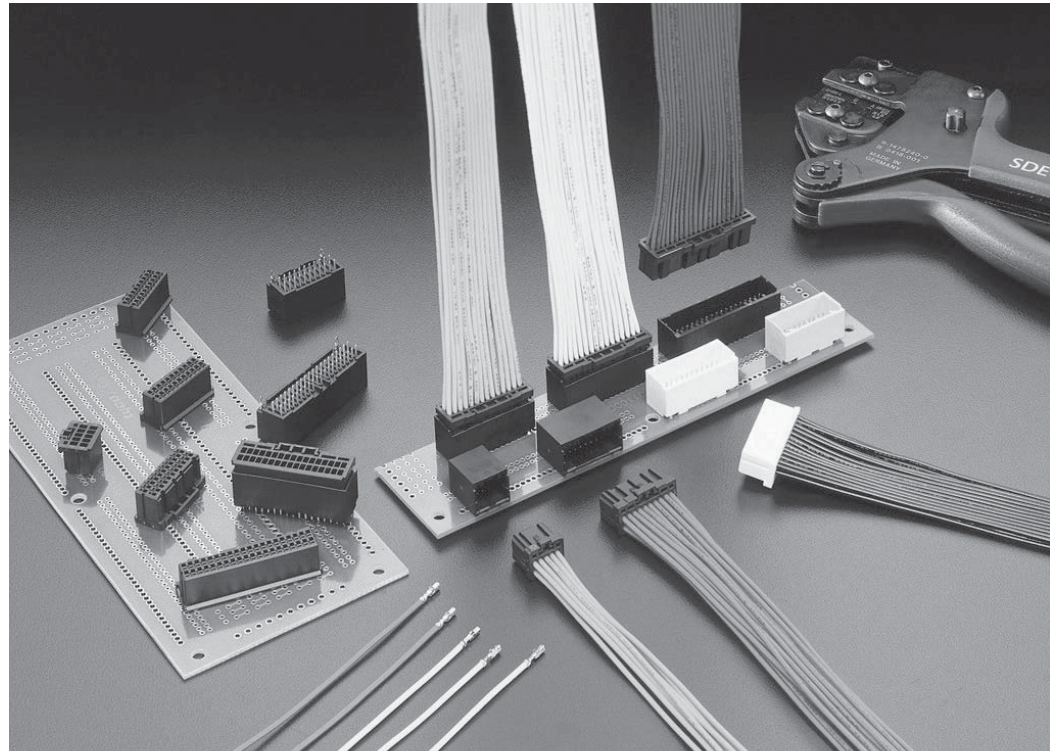

Product Features

1. Wide Applicable Wire

From D-1000 series has wide applicable wire range of 30 AWG to 18 AWG with maximum 2.2 mm of outside diameter (D-1200/ D-1500). Therefore there are no special safety considerations using it in electrical cabinets.

2. Hand Tools are available for all wire sizes.

It can save on delivery lead time and minimize installation tooling costs.

3. Housing and Contact Features

A) Housing products

The D-1000 series consists of D-1100 series with 2.0mm pitch center line, D-1200 series with 2.5mm pitch center line. In addition, the D-1500 series and D-1900 series have a pitch of 3.5mm

B) Contact Products

D-1000 series provide gold plating contact as standard products and also tin plating contact for economical market needs. Choose contact according to specifications, application, quality level and cost.

4. Other Features (Basic Dynamic series features)

- Header connector and tab connector have enough length from the tip of contact to top of its housing. To prevent contact from bending during mating
- D-1000 series are provided with housing lance structure
- Clear identification of circuit number helps with correct wiring
- Metal retention leg on header prevents unwanted movement from cable tension
- Housing lock design avoid wire scratching

Note: All models are RoHS compliant.

D-1000 Series Performance and Specifications

Performance

Item \ series	D-1100	D-1200	D-1500	D-1900
Pitch	2.0mm	2.5mm	3.5mm	3.5mm
Rated voltage	125V AC/DC	250V AC/DC	250V AC/DC	150V AC/DC
Rated current (Max)	1 pos: 3A With AWG22	1 pos: 5A (With AWG18)	1 pos: 5A (With AWG18)	1 pos: 4A With AWG18
Contact resistance	20m Ω Max			40mΩ Max
Withstanding Voltage	1,000V AC	1,500V AC	1,500V AC	1,100V AC
Operation Temperature	-55°C ~+105°C			-30°C ~+105°C

Positions/ wire size / rated current

D-1100-1500 series

Position	Wire Size (AWG)						
	18	20	22	24	26	28	30
1	5	4	3	2.5	2	1.5	1
2-20	3.5	2.7	2.5	2	1.5	1	0.8
21-40	-	-	2	1.5	1	0.8	0.5

D-1900 series

Position	Wire Size (AWG)			
	18	20	22	24
8-12	3	2	1.5	1
13-38	2	1.5	1	0.5

Product Specifications

Product Specifications		108-78268 (gold-plated)
		108-78298 (Tin-plated)
		108-78336 (D-1900)
Applications Specifications		114-5377 (D-1100, D-1200, D-1500)
		411-78291(D-1900)
Crimping tool instruction sheet	Part number: 1762952-1	408-10414-JPN
	Part number: 1762846-1	
	Part number: 1762950-1	
	Part number: 1762625-1	
Extraction tool part number: 1891526-1 D-1900 Extraction tool part number: 1891348-1		411-78241 411-78263

Materials and Plating

Description	Material	Finish
Receptacle Contacts Tab Contact	Copper alloy	Tin-plating or 0.38µm gold-plating over 1.27µm Nickel under-plated
Board Mount Header	Copper alloy	0.38 µm gold-plating over 1.27 µm Nickel under-plated 2.0 µm Tin-plating on tail side
Housing	UL94V-0, Thermoplastic PBT containing glass fiber	

Safety Standards

*Remember to obtain Instruction Sheets when you choose to use these tools. You can get electronic catalogue pages or instruction sheets on the Internet.

The safety specifications listed below are approved on specific part numbers. Please contact our Technical Support Centre to check whether the part numbers you use are approved or not. Keep in mind that there are instances where values differ from those given by Tyco Electronics Specifications.

series \ Specifications	D-1100			D-1200, D-1500			D-1900																																								
	Rated Voltage	Rated Current	Temperature Range	Rated Voltage	Rated Current	Temperature Range	Rated Voltage	Rated Current	Temperature Range																																						
Product Specifications 108-78268	125V AC/DC	3A (1 pos)	-55°C ~+105°C	250V AC/DC	5A (1 pos)	-55°C ~+105°C	150V AC/DC	4A (1 pos)	-30°C ~+105°C																																						
UL File No.E28476	Based on requirements of Application	Based on requirements of Application	-	Based on requirements of Application	Based on requirements of Application	-	Based on requirements of Application	Based on requirements of Application	-																																						
CSA Report No.LR7189	125V AC/DC	3A	—	250V AC/DC	5A	—	150V AC/DC	4A (1 pos)	—																																						
TÜV	125V AC/DC	<table border="1"> <thead> <tr> <th>AWG</th> <th>A (1pos)</th> </tr> </thead> <tbody> <tr><td>22</td><td>3</td></tr> <tr><td>24</td><td>2.5</td></tr> <tr><td>26</td><td>2</td></tr> <tr><td>28</td><td>1.5</td></tr> <tr><td>30</td><td>1</td></tr> </tbody> </table>	AWG	A (1pos)	22	3	24	2.5	26	2	28	1.5	30	1	-55°C ~+105°C	250V AC/DC	<table border="1"> <thead> <tr> <th>AWG</th> <th>A (1pos)</th> </tr> </thead> <tbody> <tr><td>18</td><td>5</td></tr> <tr><td>20</td><td>4</td></tr> <tr><td>22</td><td>3</td></tr> <tr><td>24</td><td>2.5</td></tr> <tr><td>26</td><td>2</td></tr> <tr><td>28</td><td>1.5</td></tr> <tr><td>30</td><td>1</td></tr> </tbody> </table>	AWG	A (1pos)	18	5	20	4	22	3	24	2.5	26	2	28	1.5	30	1	-55°C ~+105°C	150V AC/DC	<table border="1"> <thead> <tr> <th>AWG</th> <th>A (1pos)</th> </tr> </thead> <tbody> <tr><td>18</td><td>4</td></tr> <tr><td>20</td><td>3</td></tr> <tr><td>22</td><td>2.5</td></tr> <tr><td>24</td><td>2</td></tr> </tbody> </table>	AWG	A (1pos)	18	4	20	3	22	2.5	24	2	-30°C ~+105°C
AWG	A (1pos)																																														
22	3																																														
24	2.5																																														
26	2																																														
28	1.5																																														
30	1																																														
AWG	A (1pos)																																														
18	5																																														
20	4																																														
22	3																																														
24	2.5																																														
26	2																																														
28	1.5																																														
30	1																																														
AWG	A (1pos)																																														
18	4																																														
20	3																																														
22	2.5																																														
24	2																																														

Some part numbers are not available yet. Please contact our Sales Department for more information.

D-1000 Series Configurations

D-1100S Single-row Type

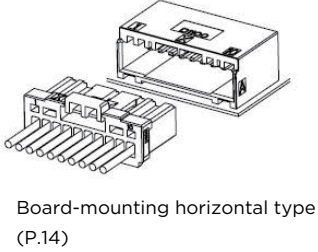

D-1100D Double-row Type

D-1100D Board-mounting horizontal type (P.15)

D-1100D Receptacle housing (P.15)

D-1100D Free Hanging type (P.15)

D-1100D Board-mounting vertical type (P.15)

D-1100D Panel type (P.15)

D-1100D Receptacle housing (P.15)

D-1200D Double-row Type

D-1200D Board-mounting horizontal type (P.19)

D-1200D Receptacle housing (P.19)

D-1200D Free Hanging type (P.19)

D-1200D Panel type (P.19)

D-1200D Board-mounting horizontal type (P.19)

D-1200D Receptacle housing (P.19)

D-1200S Single-Row Type

D-1200S Receptacle housing (P.18)

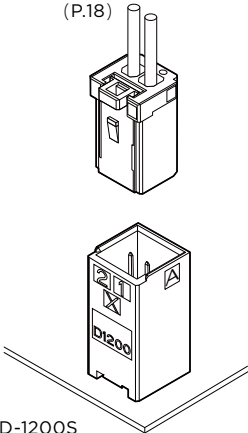

D-1200S Free Hanging type (P.18)

D-1200S Receptacle housing (P.18)

D-1500T Board-mounting horizontal type (P.22)

D-1500T Receptacle housing (P.22)

D-1500T Triple-row Type

D-1500T Receptacle housing (P.22)

D-1500T Board-mounting vertical type (P.22)

D-1500T Junction

D-1500T Receptacle housing (P.22)

D-1900D Board-mounting horizontal type (P.25)

D-1900D Receptacle housing (P.25)

D-1500T Panel housing vertical type (P.24)

D-1500T Receptacle housing (P.24)

D-1900D Double-Row Type

D-1000 Series Contact

■ Crimp Contacts

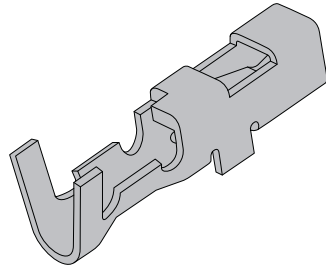

Receptacle Contact
(for Receptacle housing)

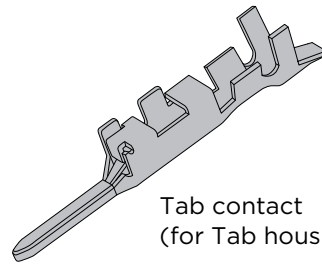

Tab contact
(for Tab housing)

Wire Range		Outside Diameter of Insulation mm	Wire Range Mark	Contacts					Applicable tools	
AWG	mm ²			Receptacle Contact			Tab Contact		CCII hand tool PEW12 hand tool* (PEW12 dies Only)	Tool numbers Mini Applicator
				Plating	Strip form	Loose Piece	Strip form	Loose Piece		
30	0.05	0.6-1.2	S	Gold Plating	1827569-2	1827586-2	1903111-2	1903115-2	2119144-1 1762952-1* (1762453-1)	2114042-2
28	0.10			Tin plating	—	—	—	—		
28	0.08	1.08-1.6	M	Gold Plating	1827570-2	1827587-2	1903112-2	1903116-2	2119141-1 1762846-1* (1762847-1)	2151082-1
26	0.12			Tin plating	1871303-1	1871743-1	1903120-1	1903124-1		
24	0.20									
22	0.37									
28	0.08	1.08-1.9	L	Gold Plating	1827571-2	1827588-2	1903113-2	1903117-2	2119143-1 1762950-1* (1762951-1)	2114043-2
26	0.12			Tin plating	1871304-1	1871744-1	1903121-1	1903125-1		
24	0.20									
22	0.37									
22	0.34-0.37	1.4-2.2	2L	Gold Plating	1827572-2	1827589-2	1903114-2	1903118-2	2119142-1 1762625-1* (1762626-1)	2151083-1
20	0.51-0.53			Tin plating	1871731-1	1871745-1	1903122-1	1903126-1		
18	0.85-0.87									

Remarks: **The contacts L and 2L do not fit into the D-1100 receptacle housing and tab housing.**
 When ordering, specify your requirements by multiplying the quantity.
 Contact our Sales Department for more information.
 Gold Plating: 0.38µm Tin plating: 2.0µm
 For mini-applicators information, contact our Sales Department.

Keying plug: 1939588-1

Strip Form contacts are used with Mini-applicators (bench machine) and Loose-Piece contacts are with hand tools.

Keying Plug with flip locator use CCII hand tools (CERT@CRIMP11)

PEW12 dies are interchangeable hand tools.
 * Only hand tools are available with dies, part number 9-147824D-0

Receptacle contacts are only available for receptacle housings, while the Tab housings are only available for tab housings. Refer to pages P.107-112 for details of applicable tools.

Note: All Part Numbers are RoHS compliant.

D1100S Single-row Standard Types

Type Chart

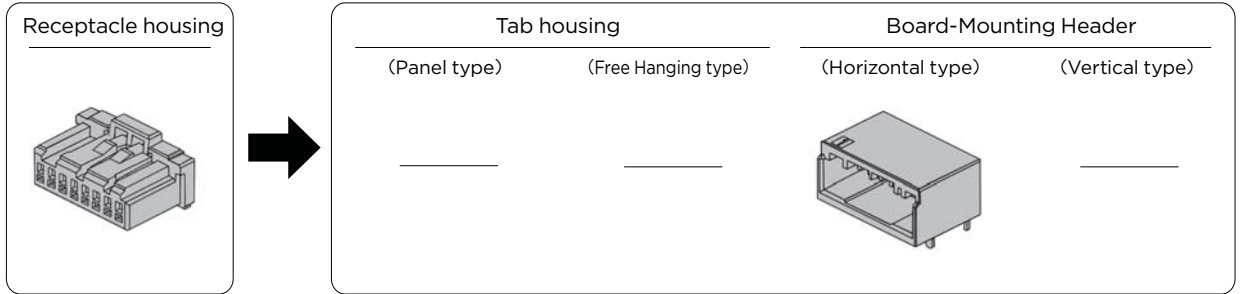

Pos	Color	Key	Receptacle housing	Tab housing		Plating	Board-Mounting Header	
				Panel type	Free Hanging type		Horizontal type	Vertical type
4	Black	X	1-1939758-4	—	—	Gold	1-1939760-4	—
		Y	2-1939758-4	—	—	Tin	1-1939761-4	—
8	Black	X	1-1939758-8	—	—	Gold	1-1939760-8	—
		Y	2-1939758-8	—	—	Gold	2-1939760-8	—
10	Black	X	1-1939758-0	—	—	Gold	1-1939760-0	—
		Y	2-1939758-0	—	—	Tin	1-1939761-0	—
				—	—	Gold	2-1939760-0	—

Relative Product Information

Applicable contact ...P.13
Performance & Specifications ...P.11

Mated Dimensions

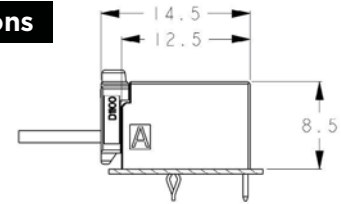

External Dimensions

Receptacle Housing

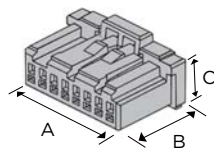

Board-Mounting Header

Horizontal type

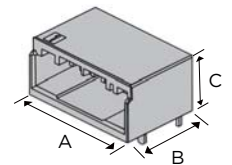

Pos	Key	Color	Part Number	Dimensions		
				A	B	C
4	X	Black	1-1939758-4	8.9	11.3	9.15
	Y		2-1939758-4			
8	X	Black	1-1939758-8	16.9	11.3	9.15
	Y		2-1939758-8			
10	X	Black	1-1939758-0	20.9	11.3	9.15
	Y		2-1939758-0			

Pos	Key	Plating	Color	Part Number	Dimensions		
					A	B	C
4	X	Gold	Black	1-1939760-4	10.6	12.5	8.5
		Tin		1-1939761-4			
	Y	Gold		2-1939760-4			
8	X	Gold	Black	1-1939760-8	18.6	12.5	8.5
		Tin		1-1939761-8			
	Y	Gold		2-1939760-8			
10	X	Gold	Black	1-1939760-0	22.6	12.5	8.5
		Tin		1-1939761-0			
	Y	Gold		2-1939760-0			

D-1100D Double-row Standard Types

Type Chart

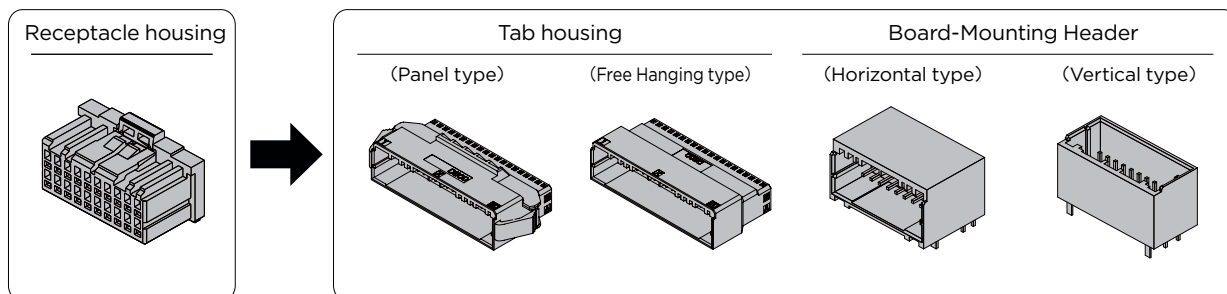

Pos	Color	Key	Receptacle housing	Tab housing		Plating	Board-Mounting Header	
				Panel type	Free Hanging type		Horizontal type	Vertical type
10	Black	X	1-1827862-5	1-2069681-5	1-2069682-5	Gold	1-1827873-5	1-2040516-5
			1-2333149-5**			Tin	1-2271887-5	1-2341421-5
18	Black	X	1-1827862-9	—	—	Gold	—	1-2040516-9
20	Black	X	1-1827862-0	—	—	Gold	1-1827873-0	—
			1-2333149-0**			Tin	1-2271887-0	1-2341421-0
22*	Black	X	1-1827863-1	1-1903128-1	1-1903127-1	Gold	—	1-1827872-1
			—			Tin	—	1-2329463-1
24	Black	X	1-1827863-2	—	—	Tin	—	1-1871315-2
			—			—	—	—
26*	Black	X	1-1827863-3	1-1903128-3	1-1903127-3	Gold	1-1939638-3	1-1827872-3
			1-2333134-3**			Tin	1-2271888-3	1-2329463-3
		Y	2-1827863-3	—	—	Gold	—	See P17 SMT
28	Black	X	1-1827863-4	1-1903128-4	1-1903127-4	Gold	1-1939638-4	1-1827872-4
			1-2333134-4**			Tin	1-2271888-4	1-2329463-4
30*	Black	X	1-1827863-5	—	—	Gold	1-1939638-5	1-1827872-5
			—			Tin	1-2271888-5	1-2329463-5
32*	Black	X	1-1827863-6	1-1903128-6	1-1903127-6	Gold	—	1-1827872-6
			—			Tin	—	1-2329463-6
34*	Black	X	1-1827863-7	1-1903128-7	1-1903127-7	Gold	1-1939638-7	1-1827872-7
			1-2333134-7**			Tin	1-2271888-7	1-2329463-7
		Y	2-1827863-7	—	—	Gold	—	2-1827872-7
40*	Black	X	1-1827863-0	1-1903128-0	1-1903127-0	Gold	1-1939638-0	1-1827872-0
			1-2333134-0**	1-2350416-0**		Tin	1-2271888-0	1-2329463-0

* There are products in other colors available. Please consult TE's sales representative.

** The product marked with "**" has a high-retention force version of Receptacle housing.

Related product information

Applicable contact ...P.13

Performance & Specifications ...P.11

Note: All Part Numbers are RoHS compliant.

D-1100D Double-row Standard Types

Mated Dimension

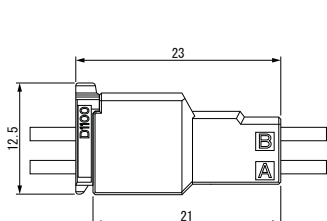

Panel/Free Hanging type

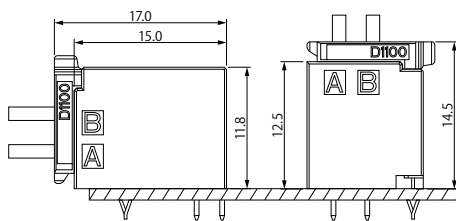

Horizontal/Vertical type

External Dimensions

■ Receptacle Housing

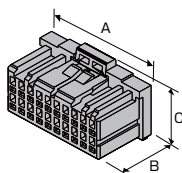

Pos	Key	Color	Part Number	Dimensions		
				A	B	C
10	X	Black	1-1827862-5	12.6	11.3	12.5
			1-2333149-5			
18	X	Black	1-1827862-9	20.6	11.3	12.5
20	X	Black	1-1827862-0	22.6	11.3	12.5
			1-2333149-0			
22	X	Black	1-1827863-1	24.6	11.3	12.5
			—			
24	X	Black	1-1827863-2	26.6	11.3	12.5
26	X	Black	1-1827863-3	28.6	11.3	12.5
			1-2333134-3			
	Y	Black	2-1827863-3			
28	X	Black	1-1827863-4	30.6	11.3	12.5
			1-2333134-4			
30	X	Black	1-1827863-5	32.6	11.3	12.5
			—			
32	X	Black	1-1827863-6	34.6	11.3	12.5
34	X	Black	1-1827863-7	36.6	11.3	12.5
			1-2333134-7			
	Y	Black	2-1827863-7			
40	X	Black	1-1827863-0	42.6	11.3	12.5
			1-2333134-0			

■ Tab Housing

Panel type

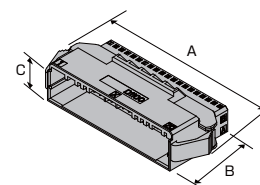

Pos	Key	Color	Part Number	Dimensions		
				A	B	C
10	X	Black	1-2069681-5	22.1	21.0	13.9
22	X	Black	1-1903128-1	34.1	21.0	13.9
26	X	Black	1-1903128-3	38.1	21.0	13.9
28	X	Black	1-1903128-4	40.1	21.0	13.9
32	X	Black	1-1903128-6	44.1	21.0	13.9
34	X	Black	1-1903128-7	46.1	21.0	13.9
			1-1903128-0			
			1-2350416-0			
40	X	Black	1-1903128-0	52.1	21.0	13.9

Free Hanging type

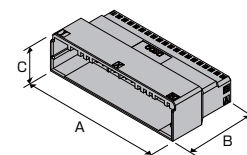

Pos	Key	Color	Part Number	Dimensions		
				A	B	C
10	X	Black	1-2069682-5	12.6	21.0	11.3
22	X	Black	1-1903127-1	24.6	21.0	11.3
26	X	Black	1-1903127-3	28.6	21.0	11.3
28	X	Black	1-1903127-4	30.6	21.0	11.3
32	X	Black	1-1903127-6	34.6	21.0	11.3
34	X	Black	1-1903127-7	36.6	21.0	11.3
40	X	Black	1-1903127-0	42.6	21.0	11.3

Note: All Part Numbers are RoHS compliant.

D-1100D Double-row Standard Types

Board-Mounting Header

Horizontal type

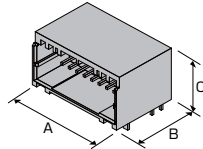

Pos	Key	Plating	Color	Part Number	Dimensions		
					A	B	C
10	X	Gold	Black	1-1827873-5	12.6	15.0	11.8
		Tin		1-2271887-5			
20	X	Gold	Black	1-1827873-0	22.6	15.0	11.8
		Tin		1-2271887-0			
26	X	Gold	Black	1-1939638-3	28.6	15.0	11.8
		Tin		1-2271888-3			
28	X	Gold	Black	1-1939638-4	30.6	15.0	11.8
		Tin		1-2271888-4			
30	X	Gold	Black	1-1939638-5	32.6	15.0	11.8
		Tin		1-2271888-5			
34	X	Gold	Black	1-1939638-7	36.6	15.0	11.8
		Tin		1-2271888-7			
40	X	Gold	Black	1-1939638-0	42.6	15.0	11.8
		Tin		1-2271888-0			

Vertical type

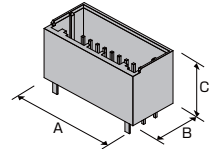

Pos	Key	Plating	Color	Part Number	Dimensions		
					A	B	C
10	X	Gold	Black	1-2040516-5	12.6	11.3	12.5
		Tin		1-2341421-5			
18	X	Gold	Black	1-2040516-9	20.6	11.3	12.5
20	X	Tin	Black	1-2341421-0	22.6	11.3	12.5
22	X	Gold	Black	1-1827872-1	24.6	11.3	12.5
		Tin		1-2329463-1			
24	X	Tin	Black	1-1871315-2	26.6	11.3	12.5
26	X	Gold	Black	1-1827872-3	28.6	11.3	12.5
		Tin		1-2329463-3			
28	X	Gold	Black	1-1827872-4	30.6	11.3	12.5
		Tin		1-2329463-4			
30	X	Gold	Black	1-1827872-5	32.6	11.3	12.5
		Tin		1-2329463-5			
32	X	Gold	Black	1-1827872-6	34.6	11.3	12.5
		Tin		1-2329463-6			
34	X	Gold	Black	1-1827872-7	36.6	11.3	12.5
		Tin		1-2329463-7			
40	X	Gold	Black	1-1827872-0	42.6	11.3	12.5
		Tin		1-2329463-0			

SMT

Board-Mounting Header

Vertical type

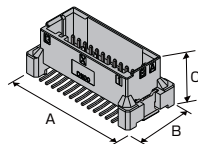

Pos	Key	Plating	Color	Part Number	Dimensions		
					A	B	C
26	X	Gold	Black	1-1939995-3	34.6	16.3	13.5
				1-2339471-3*			
40	Y	Gold	Black	2-1939995-3	48.6	16.3	13.5
				1-1939995-0			
40	Y	Gold	Black	1-1939995-0	48.6	16.3	13.5
				2-1939995-0			

* Packaging form: emboss.

Note: All Part Numbers are RoHS compliant.

D-1200S Single Row/High Voltage Types

Type Chart

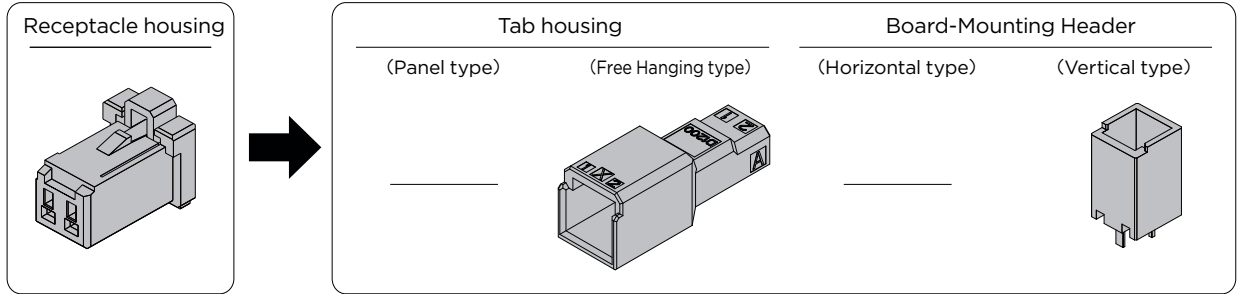

Pos	Color	Key	Receptacle housing	Tab housing		Plating	Board-Mounting Header	
				Panel type	Free Hanging type		Horizontal type	Vertical type
2	Black	X	1-1871465-2	—	1-1903129-2	Gold	—	1-1871468-2
	—	Y	—	—	—	Tin	—	1-2348456-2

Relative Product Information

Applicable contact ...P.13
Performance & Specifications ...P.11

Mated Dimension

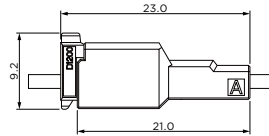

Free Hanging type

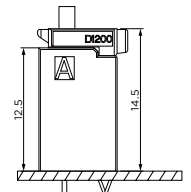

Vertical type

External Dimensions

Receptacle Housing

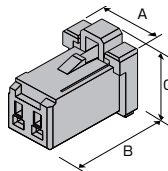

Pos	Key	Color	Part Number	Dimensions		
				A	B	C
2	X	Black	1-1871465-2	7.6	11.3	9.2

Tab Housing

Free Hanging type

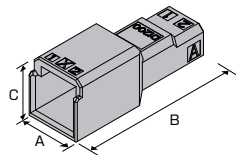

Pos	Key	Color	Part Number	Dimensions		
				A	B	C
2	X	Black	1-1903129-2	7.6	21.0	8.0

Board-Mounting Header

Vertical type

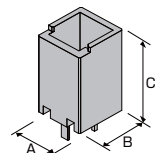

Pos	Key	Plating	Color	Part Number	Dimensions		
					A	B	C
2	X	Gold	Black	1-1871468-2	7.6	8.0	12.5

Note: All Part Numbers are RoHS compliant.

D-1200D Double Row High Voltage Types

Type Chart

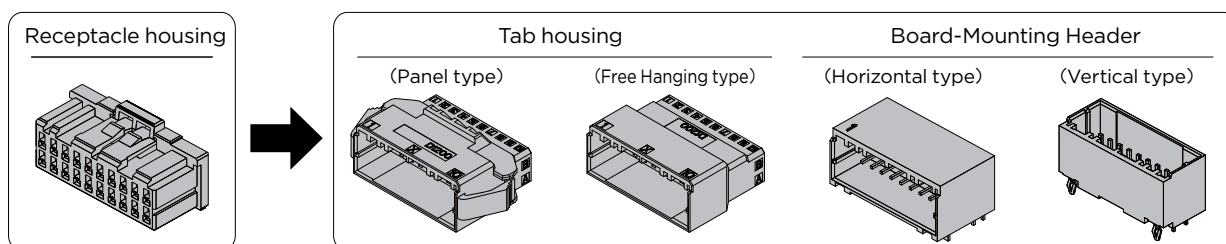

Pos	Color	Key	Receptacle housing	Tab housing		Plating	Board-Mounting Header	
				Panel type	Free Hanging type		Horizontal type	Vertical type
4	Black	X	1-1827864-2 9-1827864-2*	1-1903131-2	1-1903130-2	Gold	1-1827876-2	1-1827875-2
		Y	2-1827864-2	—	—	Tin	1-2348455-2	1-2348454-2
	Black	Y	2-1827864-2	—	—	Gold	2-1827876-2	2-1827875-2
		X	1-1827864-3 9-1827864-3*	1-1903131-3	1-1903130-3	Gold	1-1827876-3	1-1827875-3
6	Black	X	1-1827864-3 9-1827864-3*	1-1903131-3	1-1903130-3	Tin	1-2348455-3	1-2348454-3
		Y	2-1827864-3	2-1903131-3	2-1903130-3	Gold	2-1827876-3	2-1827875-3
8	Black	X	1-1827864-4 1-2349949-4**	1-1903131-4	1-1903130-4	Gold	1-1827876-4	1-1827875-4
		Y	2-1827864-4	2-1903131-4	2-1903130-4	Tin	1-2348455-4	1-2348454-4
	Black	Y	2-1827864-4	2-1903131-4	2-1903130-4	Gold	2-1827876-4	2-1827875-4
		X	1-1827864-5	—	—	Gold	—	1-1827875-5
10	Black	X	1-1827864-5	—	—	Tin	—	1-2348454-5
		Y	2-1827864-5	—	—	Gold	—	2-1827875-5
12	Black	X	1-1827864-6 9-1827864-6* 1-2349949-6**	1-1903131-6	1-1903130-6	Gold	1-1827876-6	1-1827875-6
		Y	2-1827864-6	—	—	Tin	1-2348455-6	1-2348454-6
	Black	Y	2-1827864-6	—	—	Gold	—	2-1827875-6
		X	1-1827864-8	—	—	Gold	—	1-1827875-8
16	Black	X	1-1827864-8	—	—	Tin	—	1-2348454-8
		Y	2-1827864-8	—	—	Gold	—	2-1827875-8
20	Black	X	1-1827864-0	1-1903131-0	1-1903130-0	Gold	1-1827876-0	1-1827875-0
		Y	2-1827864-0	2-1903131-0	2-1903130-0	Tin	1-2348455-0	1-2348454-0
	Black	Y	2-1827864-0	2-1903131-0	2-1903130-0	Gold	2-1827876-0	2-1827875-0

* The Receptacle housing 9-1827864-□ is a latch-protected product with different locking heights. Please refer to P. 20

** The product marked with “**” is high-retention force version of Receptacle housing.

Relative Product Information

Applicable contact ...P.13

Performance & Specifications ...P.11

Note: All Part Numbers are RoHS compliant.

D-1200D Double-row High-voltage Types

Mated Dimension

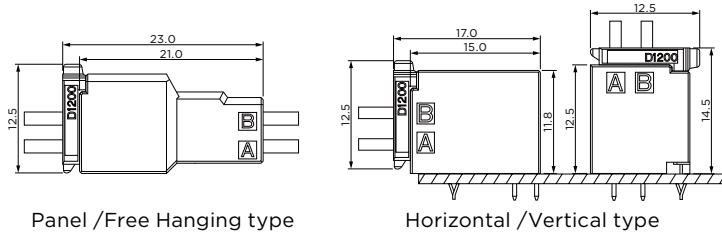

External Dimensions

■ Receptacle Housing

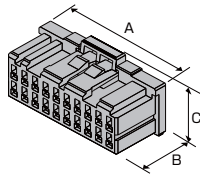

Pos	Key	Color	Part Number	Dimensions		
				A	B	C
4	X	Black	1-1827864-2	7.6	11.3	12.5
		Black	9-1827864-2*			12.65
	Black	2-1827864-2	12.5			
6	X	Black	1-1827864-3	10.1	11.3	12.5
		Black	9-1827864-3*			12.65
	Black	2-1827864-3	12.5			
8	X	Black	1-1827864-4	12.6	11.3	12.5
		Black	1-2349949-4**			
	Black	2-1827864-4				
10	X	Black	1-1827864-5	15.1	11.3	12.5
	Y	Black	2-1827864-5			
12	X	Black	1-1827864-6	17.6	11.3	12.5
		Black	9-1827864-6*			12.65
		Black	1-2349949-6**			
	Black	2-1827864-6	12.5			
16	X	Black	1-1827864-8	22.6	11.3	12.5
	Y	Black	2-1827864-8			
20	X	Black	1-1827864-0	27.6	11.3	12.5
	Y	Black	2-1827864-0			

* The product with protective latches has different locking heights.
 ** The product marked with "*" has high-retention force version of Receptacle housing.

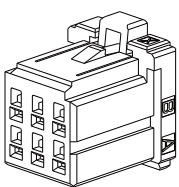

Standard products:
6P; key X:
1-1827864-3

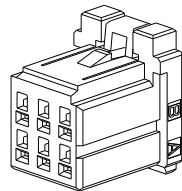

Products with protective
latches: 6P; key X:
9-1827864-3

■ Tab Housing

Panel type

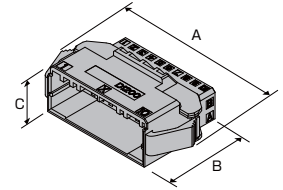

Pos	Key	Color	Part Number	Dimensions		
				A	B	C
4	X	Black	1-1903131-2	17.1	21.0	13.9
6	X	Black	1-1903131-3	19.6	21.0	13.9
	Y		2-1903131-3			
8	X	Black	1-1903131-4	22.1	21.0	13.9
	Y		2-1903131-4			
12	X	Black	1-1903131-6	27.1	21.0	13.9
20	X	Black	1-1903131-0	37.1	21.0	13.9
	Y		2-1903131-0			

Free Hanging type

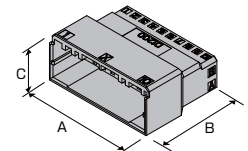

Pos	Key	Color	Part Number	Dimensions		
				A	B	C
4	X	Black	1-1903130-2	7.6	21.0	11.3
6	X	Black	1-1903130-3	10.1	21.0	11.3
	Y		2-1903130-3			
8	X	Black	1-1903130-4	12.6	21.0	11.3
	Y		2-1903130-4			
12	X	Black	1-1903130-6	17.6	21.0	11.3
20	X	Black	1-1903130-0	27.6	21.0	11.3
	Y		2-1903130-0			

Note: All Part Numbers are RoHS compliant.

D-1200D Double-row High-voltage Types

Board-Mounting Header

Horizontal type

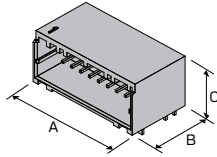

Pos	Key	Plating	Color	Part Number	Dimensions		
					A	B	C
4	X	Gold	Black	1-1827876-2	7.6	15.0	11.8
		Tin	Black	1-2348455-2			
	Y	Gold	Black	2-1827876-2			
6	X	Gold	Black	1-1827876-3	10.1	15.0	11.8
		Tin	Black	1-2348455-3			
	Y	Gold	Black	2-1827876-3			
8	X	Gold	Black	1-1827876-4	12.6	15.0	11.8
		Tin	Black	1-2348455-4			
	Y	Gold	Black	2-1827876-4			
12	X	Gold	Black	1-1827876-6	17.6	15.0	11.8
		Tin	Black	1-2348455-6			
	Y	Gold	Black	2-1827876-6			
20	X	Gold	Black	1-1827876-0	27.6	15.0	11.8
		Tin	Black	1-2348455-0			
	Y	Gold	Black	2-1827876-0			

Vertical type

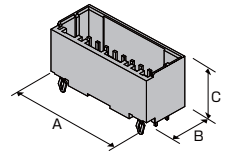

Pos	Key	Plating	Color	Part Number	Dimensions		
					A	B	C
4	X	Gold	Black	1-1827875-2	7.6	11.3	12.5
		Tin	Black	1-2348454-2			
	Y	Gold	Black	2-1827875-2			
6	X	Gold	Black	1-1827875-3	10.1	11.3	12.5
		Tin	Black	1-2348454-3			
	Y	Gold	Black	2-1827875-3			
8	X	Gold	Black	1-1827875-4	12.6	11.3	12.5
		Tin	Black	1-2348454-4			
	Y	Gold	Black	2-1827875-4			
10	X	Gold	Black	1-1827875-5	15.1	11.3	12.5
		Tin	Black	1-2348454-5			
	Y	Gold	Black	2-1827875-5			
12	X	Gold	Black	1-1827875-6	17.6	11.3	12.5
		Tin	Black	1-2348454-6			
	Y	Gold	Black	2-1827875-6			
16	X	Gold	Black	1-1827875-8	22.6	11.3	12.5
		Tin	Black	1-2348454-8			
	Y	Gold	Black	2-1827875-8			
20	X	Gold	Black	1-1827875-0	27.6	11.3	12.5
		Tin	Black	1-2348454-0			
	Y	Gold	Black	2-1827875-0			

Fan Motor Water-Proof 3P

Wire-To-Wire

Panel mount type

Pos	Part Number	
3	Male	2013891-1
	Female	2013892-1

Note: All Part Numbers are RoHS compliant.

D-1500T Triple-row High-voltage Modular Type

Type Chart

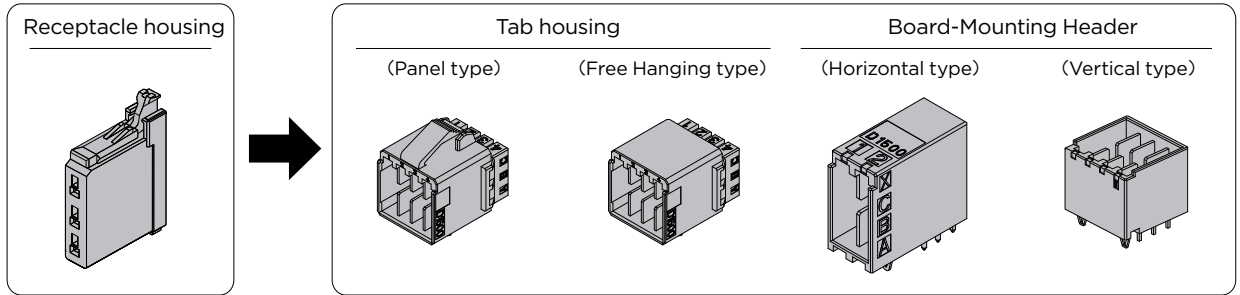

Pos	Color	Key	Receptacle housing	Tab housing		Plating	Board-Mounting Header	
				Panel type	Free Hanging type		Horizontal type	Vertical type
3	Black	X	1-1827579-1	—	1-2040444-1	—	—	1-1827581-1
6	Black	X	1-2069029-2	1-2040404-2	1-2040444-2	Gold	1-1827583-2	1-1827581-2
9	Black	X	1-2069029-3	—	1-2040444-3	Gold	—	1-1827581-3
12	Black	X	1-2069029-4	—	1-2040444-4	Gold	—	1-1827581-4
36	Black	X	—	3-2040404-2	—	Gold	—	—

Relative Product Information

Applicable contact ...P.13

Performance & Specifications ...P.11

Mated Dimension

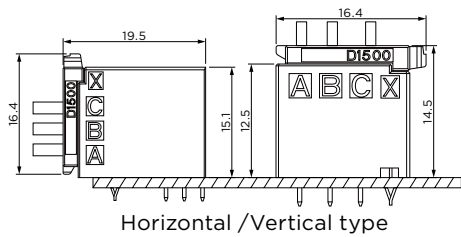

Horizontal /Vertical type

Receptacle Housing

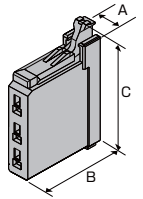

Pos	Key	Color	Part Number	Dimensions		
				A	B	C
3	X	Black	1-1827579-1	3.3	11.3	16.4
6	X	Black	1-2069029-2	6.8	11.3	16.4
9	X	Black	1-2069029-3	10.3	11.3	16.4
12	X	Black	1-2069029-4	13.8	11.3	16.4

Note: All Part Numbers are RoHS compliant.

D-1500T Triple-row High-voltage Modular Type

External Dimensions

■ Tab Housing

Panel type

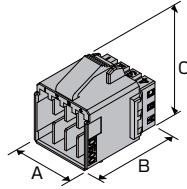

Pos	Key	Color	Part Number	Dimensions		
				A	B	C
6	X	Black	1-2040404-2	8.5	21.0	24.5
36	X	Black	3-2040404-2	43.5	21.0	24.5

Free Hanging type

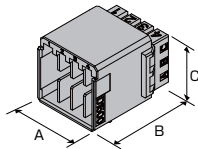

Pos	Key	Color	Part Number	Dimensions		
				A	B	C
3	X	Black	1-2040444-1	3.0	21.0	15.0
6	X	Black	1-2040444-2	6.5	21.0	15.0
9	X	Black	1-2040444-3	10.0	21.0	15.0
12	X	Black	1-2040444-4	13.5	21.0	15.0

Note: All Part Numbers are RoHS compliant.

■ Board-Mounting Header

Horizontal type

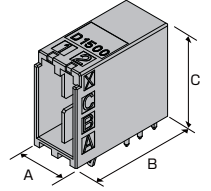

Pos	Key	Plating	Color	Part Number	Dimensions		
					A	B	C
6	X	Gold	Black	1-1827583-2	8.1	17.5	15.1

Vertical type

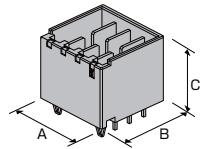

Pos	Key	Plating	Color	Part Number	Dimensions		
					A	B	C
3	X	Gold	Black	1-1827581-1	4.6	14.6	12.5
6	X	Gold	Black	1-1827581-2	8.1	14.6	12.5
9	X	Gold	Black	1-1827581-3	11.6	14.6	12.5
12	X	Gold	Black	1-1827581-4	15.1	14.6	12.5

D-1500T Junction Box

Type Chart

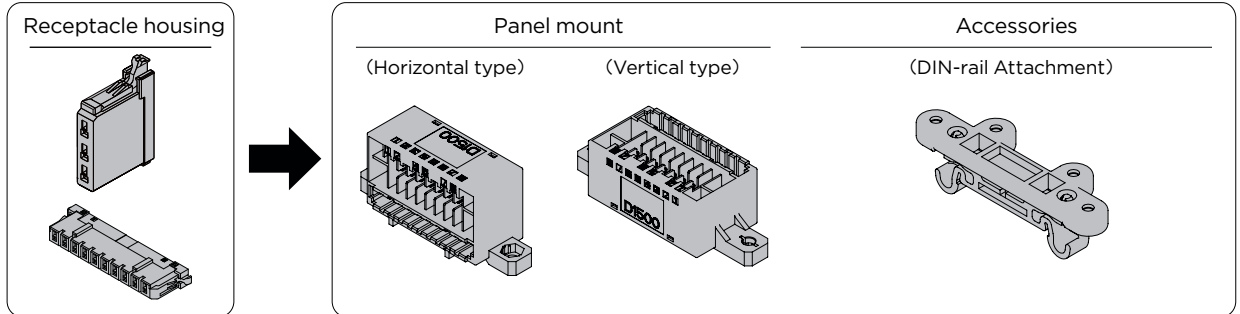

Pos	Color	Key	Receptacle housing	Plating	Panel mount		Accessories
					Horizontal type	Vertical type	DIN-rail attachmentt
3	Black	X	1-1827579-1	—	—	—	—
10	Black	—	1971150-1	—	—	—	—
34	Black	—	—	Gold	1971151-1	1971151-2	1971182-1*

* 4 screws are needed for fixation

Relative Product Information

Applicable contact ...P.13

Performance & Specifications...P.11

External Dimensions

Receptacle Housing

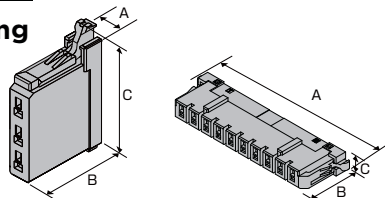

Pos	Key	Color	Part Number	Dimensions		
				A	B	C
3	X	Black	1-1827579-1	3.3	11.3	16.4
10	—	Black	1971150-1	42.2	11.3	4.6

Panel Mount

Horizontal type

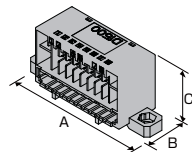

Pos	Key	Plating	Color	Part Number	Dimensions		
					A	B	C
34	—	Gold	Black	1971151-1	57.7	18.7	24.6

Note: All Part Numbers are RoHS compliant.

Vertical type

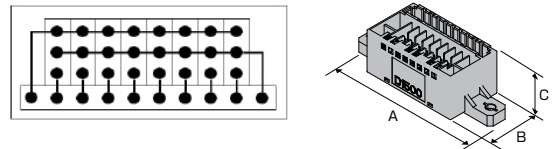

Pos	Key	Plating	Color	Part Number	Dimensions		
					A	B	C
34	—	Gold	Black	1971151-2	64.8	22.8	18.2

Accessories

Pins to be mounted with a foot attachment

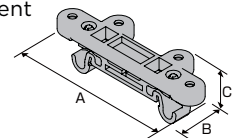

Pos	Key	Color	Part Number	Dimensions		
				A	B	C
—	—	Black	1971182-1	67.5	19.0	18.1

D-1900D Double-row Spring Clamp Type

Type Chart



Pos	Color	Key	Receptacle housing	Receptacle Assembly	Tab housing		Board-Mounting Header	
			Spring Crimp	Spring Clamp type	Panel type	Free Hanging type	Horizontal type	Vertical type
8	Black	X	1-1871946-4	1-1871940-4	—	—	1-1871935-4	1-2013325-4
12	Black	X	1-1871946-6	1-1871940-6	—	—	1-1871935-6	1-2013325-6
16	Black	X	1-1871946-8	1-1871940-8	—	—	1-1871935-8	—
22	Black	X	2-1871946-1	2-1871940-1	—	—	2-1871935-1	2-2013325-1
30	Black	X	—	2-1871940-5	—	—	—	—
38	Black	X	—	2-1871940-9	—	—	2-1871935-9	—

Relative Product Information

Applicable contact ...P.13
 Performance & Specifications ...P.11
 Special tool 1891348-1

Mated Dimension

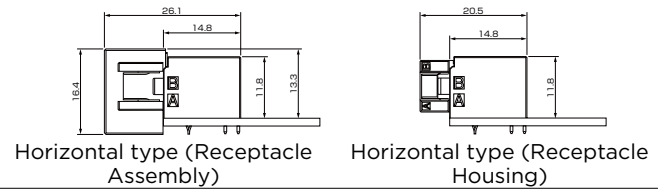

External Dimensions

■ Receptacle Housing (Crimp type)

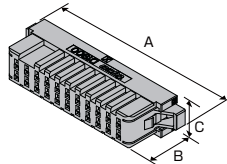

Pos	Key	Color	Part Number	Dimensions		
				A	B	C
8	X	Black	1-1871946-4	24.2	15.0	9.9
12	X	Black	1-1871946-6	34.2	15.0	9.9
16	X	Black	1-1871946-8	41.2	15.0	9.9
22	X	Black	2-1871946-1	51.7	15.0	9.9

■ Receptacle Assembly (Spring clamp)

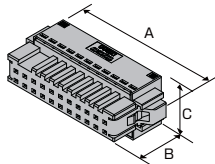

Pos	Key	Plating	Color	Part Number	Dimensions		
					A	B	C
8	X	Gold	Black	1-1871940-4	25.2	20.6	16.4
12	X	Gold	Black	1-1871940-6	32.2	20.6	16.4
16	X	Gold	Black	1-1871940-8	39.2	20.6	16.4
22	X	Gold	Black	2-1871940-1	49.7	20.6	16.4
30	X	Gold	Black	2-1871940-5	63.7	20.6	16.4
38	X	Gold	Black	2-1871940-9	77.7	20.6	16.4

Note: All Part Numbers are RoHS compliant.

■ Board-Mounting Header

Horizontal type

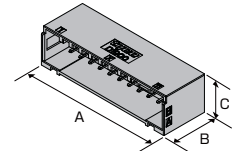

Pos	Key	Plating	Color	Part Number	Dimensions		
					A	B	C
8	X	Gold	Black	1-1871935-4	19.8	14.8	11.8
12	X	Gold	Black	1-1871935-6	26.8	14.8	11.8
16	X	Gold	Black	1-1871935-8	33.8	14.8	11.8
22	X	Gold	Black	2-1871935-1	44.3	14.8	11.8
30	X	Gold	Black	2-1871955-5	58.3	14.8	11.8
38	X	Gold	Black	2-1871935-9	72.3	14.8	11.8

Vertical type

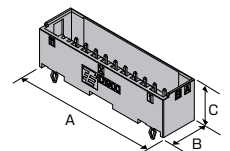

Pos	Key	Plating	Color	Part Number	Dimensions		
					A	B	C
8	X	Gold	Black	1-2013325-4	20.2	11.5	12.5
12	X	Gold	Black	1-2013325-6	26.8	11.5	12.5
22	X	Gold	Black	2-2013325-1	44.3	11.5	12.5



D-2000 Series

Series introduction

The D-2000 series is a compact connector in the Dynamic series and has the specifications for industrial machinery. Its proprietary concept-long contact wiping length-provides the high-reliability which is needed for industrial machinery. The series also includes the multi-position drawer type not found in any other series and the hybrid type that integrates signal and power contacts in a single connector.

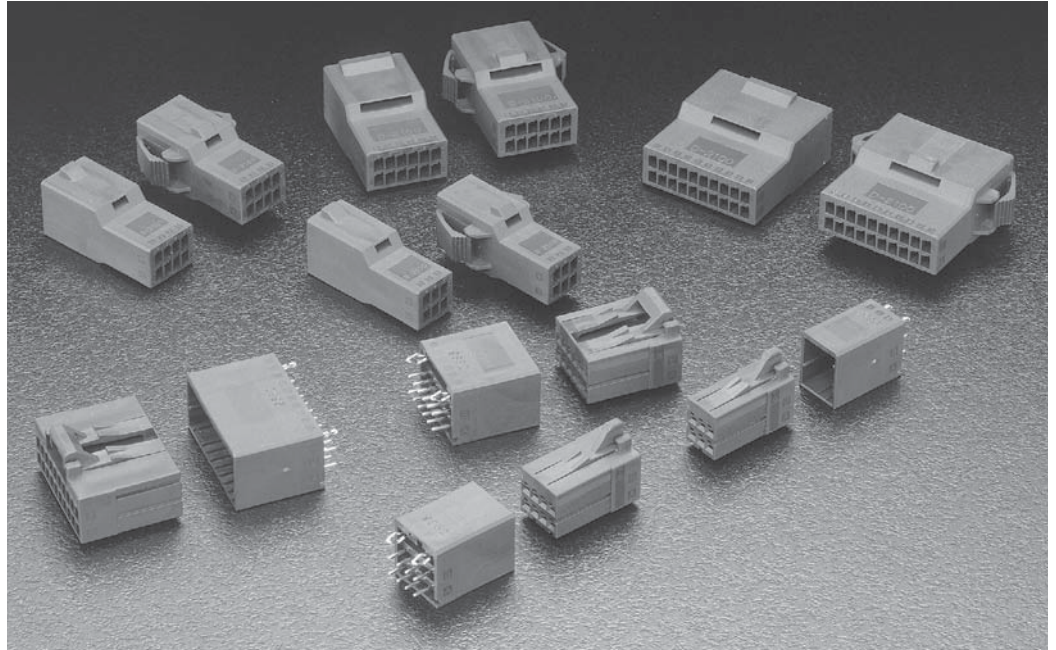

Product Features

1. Terminal and Housing Construction are Twist Resistant

The box shape receptacle contact is highly resistant to twisting and the housing slit also prevents angled mating to increase reliability.

2. Contact Wiping Length

Attaining the reliability needed for industrial machinery in a compact size by using a long contact wiping length.

3. Wire Sizes:

With its 2.5 mm pitch, it is a compact series, yet it can use 18 AWG wires, which are often used in industrial equipment.

4. Audible Latching

Obvious lock sound and feeling when mating means work can be done without mistakes, such as mismatching (halfmating), even if the connection cannot be seen.

5. Keying

The housing is keyed (with a slit), so differentiating between X keys and Y keys prevents mismatching. It is also possible to make more key patterns by using keying plugs.

6. Center Locking

This is the first application of a center lock in Dynamic series. On-board space requirements can be minimized because these connectors can be mounted in a tight space for high-density mounting on boards requiring signal lines.

7. Drawer Type

The drawer type connector was developed with a floating construction on one side for applications where it is not possible to see the connection. There can be up to 50 positions, the highest in the series. These connectors make it possible to make connections between units with flexibility.

8. Hybrid Type

The D-2600 series combines signal and power contacts in a single connector by using D-2000 contacts as signal contacts and D-3000 contacts as power ones. This saves on-board space and improves maintenance.

D-2000 Series Performance and Specifications

Performance

Item	2100S/D	2100M	2600D
Pitch	2.5mm		
Rated Current:	5A max	2.6A max	3.2A max
Rated Voltage	250V AC/DC		
Dielectric Withstanding Voltage	1500V AC	2300V AC	1500V AC
Total resistance	5mff max (initial) 10mff max (initial)		
Insertion strength	4.9N max (per pole)		
Withdrawal strength	0.29N max (per pole)		
Durability	500 cycles		
Lock strength	39.2N min	—	98N min

Product Specification

Series Name	D-2100S/D	D-2100M	D-2600D
Product Specifications	108-5619	108-5659	108-78301
Applications Specifications	114-5258		
Instruction sheet (hand tool)	408-10414 (S)		
	408-8547-1(M)		
Instruction sheet (extraction tool PN)	(1276716-1)411-5900		

Please refer to the standards on P. 39 for the D-3000 contact used in D-2600D

Please refer to the manual when using the product. An e-Catalogue is also available for download from the Internet.

Positions / wire size / Rated Current

D-2100S/D value

Position	Wire Size					
	AWG 18	AWG 20	AWG 22	AWG 24	AWG 26	AWG 28
3	5	4.5	4.3	3.3	2.9	2.3
6	5	4.2	4	2.7	2.5	2
8	4.5	4	3.5	2.5	2.2	1.8
12	4	3.5	3	2.3	1.9	1.5
16	3.2	2.8	2.4	2	1.6	1.2
20	3.2	2.8	2.4	2	1.6	1.2

Materials and Plating

Category	Material	Plating
Receptacle Contact Tab Contact	Copper alloys	0.38 µm Gold plating over nickel underplate
Board mount Header	Copper alloys	0.38 µm Gold plating over nickel underplate Tin plating on tail side
Housing	UL94-V-0, thermoplastic PBT with glass fiber	

Safety Standards

The safety specifications listed below are approved on specific part numbers. Please contact our Technical Support Centre to check whether the part numbers you use are approved or not. Keep in mind that there are instances where values differ from those given by Tyco Electronics Specifications.

Standards	series	D-2100 series			D-2100M Drawer Type		
		Rated Voltage	Rated Current	Temperature Range	Rated Voltage	Rated Current	Temperature Range
Product Specifications 108-5619 (General) 108-5659 (drawer type)		250V AC/DC	5A (unipolar)	-55°C -+105°C	250V AC/DC	2.6A [AWG#20 hours 50 pole load]	-5°C -+105°C
UL File No.E28476		Determined according to the requirements of application	Determined according to the requirements of application	—	Determined according to the requirements of application	Determined according to the requirements of application	—
CSA Report No. LR 7189		250V AC/DC	AWG#24-#28: 3.3A AWG#18-#22: 5A	—	250V AC/DC	Max 5A per pole	—
TÜV License No. R 9950679		125V AC/DC	5A	-55°C -+105°C	125V AC/DC	Max 5A per pole	-5°C -+105°C

D-2000 Series Configurations

D-2100S Single Row Type

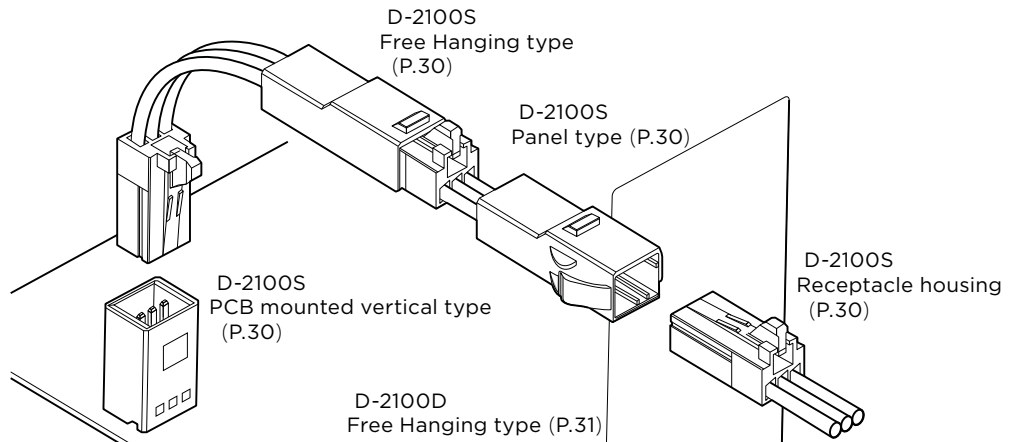

D-2100D Double Row Type

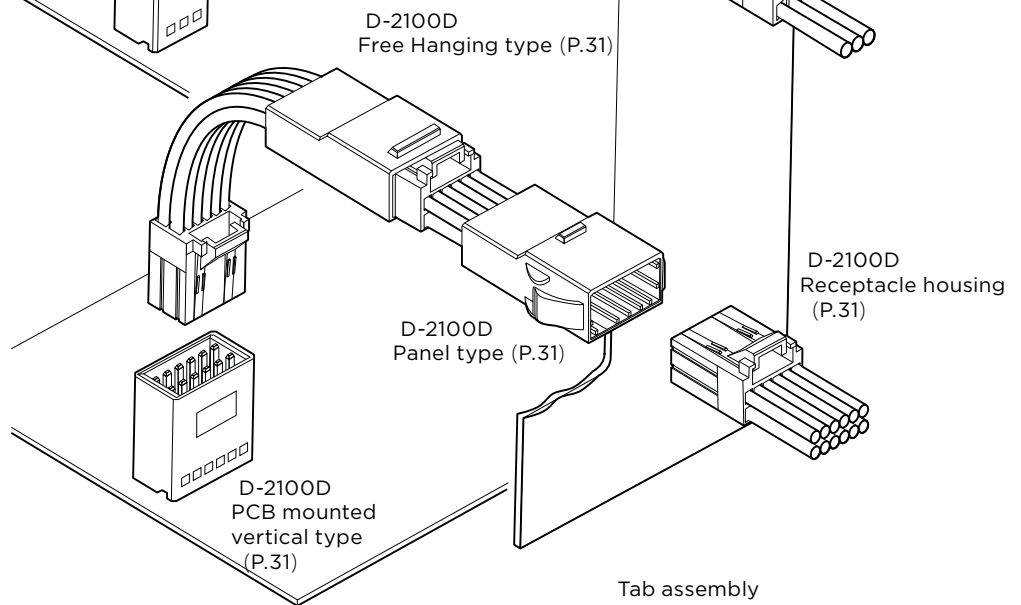

D-2100M Drawer Type

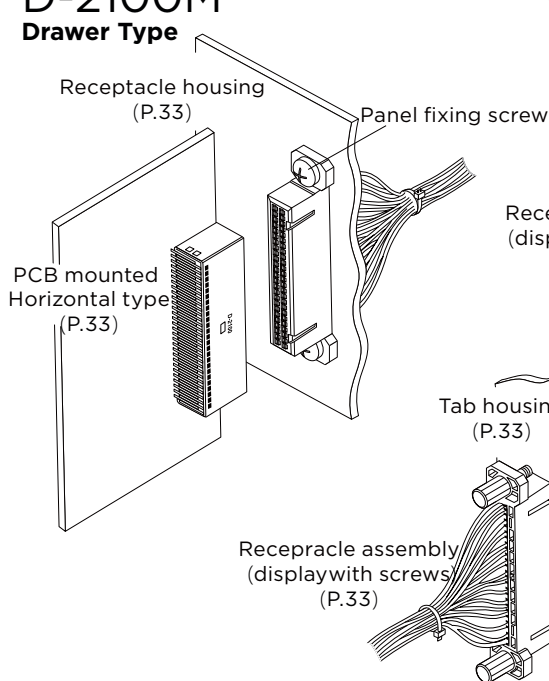

D-2600D Double-row Hybrid Type

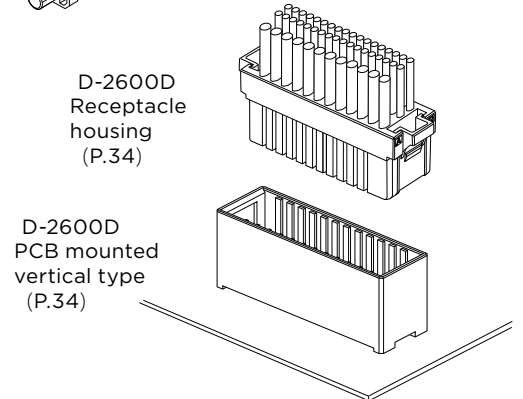

D-2000 Series Contact

■ **Crimped type**
 (gold plating thickness
 0.38 μm)

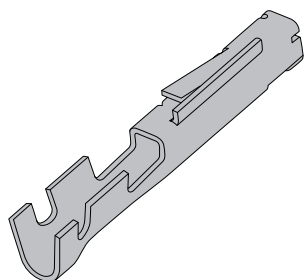

Receptacle Contact
 (used in receptacle housing)

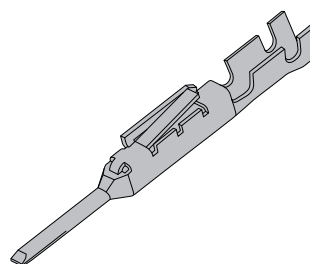

Tab contact
 (used in tab housing)

Wire Range		Outside Diameter of Insulation mm	Wire Range Mark	Contact part number				Models of applicable tools	
				Receptacle Contact		Tab Contact		Hand Tools	Tool numbers
AWG	mm ²			Strip form	Loose Piece	Strip form	Loose Piece		
28	0.09	0.88-1.3	S	1318106-1	1318108-1	1318110-1	1318112-1	91576-1	2151240-1
26	0.12								
24	0.20	1.11-1.43							
24	0.20	2.2-2.25	S1	1-1318106-1*	---	1-1318110-1*	---	---	---
22	0.30	1.26-1.8	M	1318105-1	1318107-1	1318109-1	1318111-1	91595-1	2151071-1
20	0.50								
18	0.85								

*This terminal is only applicable to the UL1051 cable.
 Note: When placing your order, please check with the confirmed sales leadtime.

Please contact our sales department or distributor for more information.

Strip Form contacts are used with Mini-applicators (bench machine) and Loose-Piece contacts are with hand tools.

The receptacle contact can be used in all receptacle housings, the Tab housing can be used in all tab housings. Details of the applicable tools are available from P.107-111

NOTE: All products are RoHS compliant On selection.

D-2100S Single-row Standard Type

Type Chat

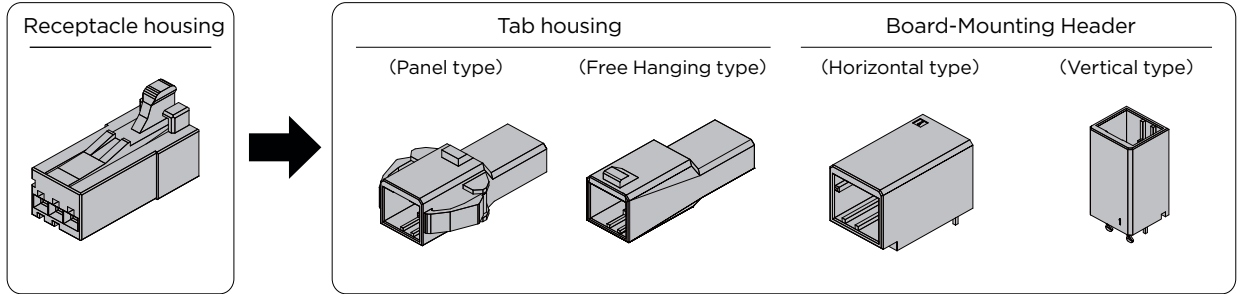

Pos	Color	Key	Receptacle housing	Tab housing		Plating	Board-Mounting Header	
				Panel type	Free Hanging type		Horizontal type	Vertical type
3	Black	X	1-1318120-3	1-1318116-3	1-1318117-3	Gold	1376135-1	1318123-1
	Black	Y	2-1318120-3	2-1318116-3	2-1318117-3	Gold	1376135-2	1318123-2
	Black	Z	3-1318120-3	—	—	Gold	1376135-3	—
	Black	X	1-1473074-3*	—	—	Gold	—	1-1318123-1

The * mark means drawer typer

Relative Product Information

Application contact...P.29
Performance & Specifications...P.27

Mated Dimension

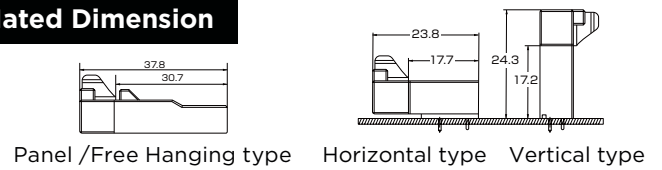

External Dimensions

Receptacle Housing

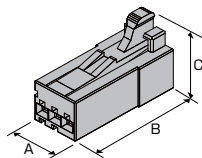

Pos	Key	Color	Part Number	Dimensions		
				A	B	C
3	X	Black	1-1318120-3	8.9	20.0	12.0
	Y	Black	2-1318120-3			
	Z	Black	3-1318120-3	8.9	20.0	11.8
	X	Black	1-1473074-3			

Tab Housing

Panel type

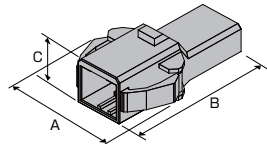

Pos	Key	Color	Part Number	Dimensions		
				A	B	C
3	X	Black	1-1318116-3	19.7	30.7	9.5
	Y	Black	2-1318116-3			

Free Hanging type

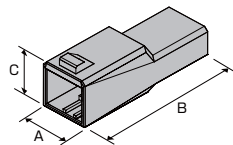

Pos	Key	Plating	Color	Part Number	Dimensions		
					A	B	C
3	X	—	Black	1-1318117-3	10.2	30.7	9.5
	Y	—	Black	2-1318117-3			

Board-Mounting Header

Horizontal type

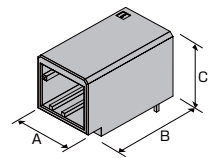

Pos	Key	Plating	Color	Part Number	Dimensions		
					A	B	C
3	X	Gold	Black	1376135-1	10.2	17.7	11.0
	Y	Gold	Black	1376135-2			
	Z	Gold	Black	1376135-3			

Vertical type

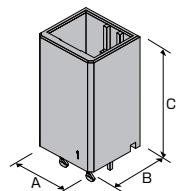

Pos	Key	Plating	Color	Part Number	Dimensions		
					A	B	C
3	X	Gold	Black	1318123-1	10.2	9.5	17.8
		Gold	Black	1-1318123-1			
	Y	Gold	Black	1318123-2			

NOTE: All products are RoHS compliant On selection.

D-2100D Double-row Standard Type

Type Chart

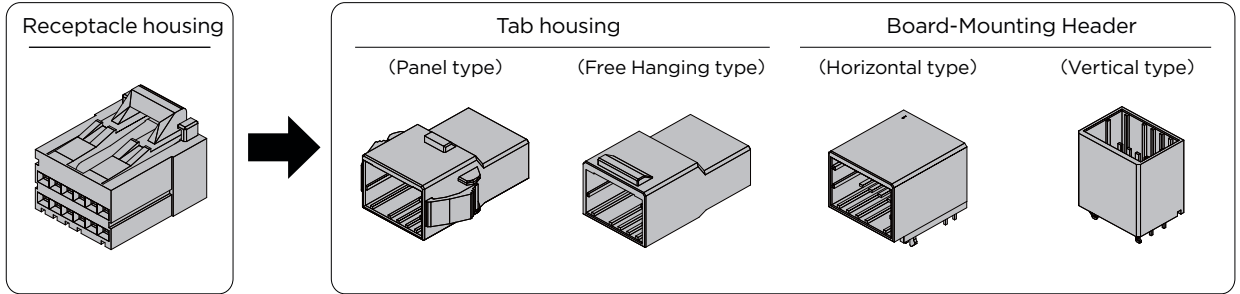

Pos	Color	Key	Receptacle housing	Tab housing		Plating	Board-Mounting Header	
				Panel type	Free Hanging type		Horizontal type	Vertical type
6	Black	X	1-1318119-3	1-1318114-3	1-1318115-3	Gold	1376136-1	1318124-1
	Black	Y	2-1318119-3	2-1318114-3	2-1318115-3	Gold	1376136-2	1318124-2
8	Black	X	1-1318119-4	1-1318114-4	1-1318115-4	Gold	1376009-1	1318125-1
	Black	Y	2-1318119-4	2-1318114-4	2-1318115-4	Gold	1-1376009-1*	1-1318125-1*
12	Black	X	1-1318118-6	1-1318114-6	1-1318115-6	Gold	1376020-1	1318125-2
	Black	Y	2-1318118-6	2-1318114-6	—	Gold	1376009-2	1-1318125-2*
	Black	Z	3-1318118-6	—	—	Gold	—	1318126-1
16	Black	X	1-1318118-8	—	—	Gold	—	1-1318126-1*
	Black	Y	2-1318118-8	—	—	Gold	—	1318126-2
20	Black	X	1-1318118-9	1-1318114-9	1-1318115-9	Gold	1376020-2	1-1318126-2*
	Black	Y	2-1318118-9	2-1318114-9	2-1318115-9	Gold	1376137-1	1318126-3
							1376137-2	1747994-1
								1318127-1
								1747994-2
								1318127-2

*Sequential product

Note: There is Z-key option in 20-position product, please contact TE sales representative for more information

Relative Product Information

Applicable contact...P.29

Performance & Specifications ...P.27

Mated Dimension

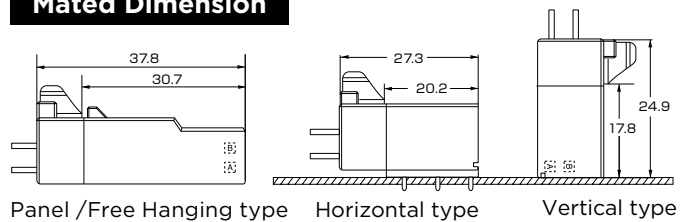

NOTE: All products are RoHS compliant On selection.

D-2100D Double-row Standard Type

External Dimensions

■ Receptacle Housing

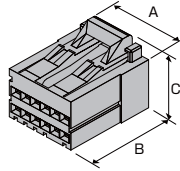

Pos	Key	Color	Part Number	Dimensions		
				A	B	C
6	X	Black	1-1318119-3	8.3	20.0	15.8
	Y	Black	2-1318119-3			
8	X	Black	1-1318119-4	10.8	20.0	15.8
	Y	Black	2-1318119-4			
12	X	Black	1-1318118-6	15.8	20.0	14.8
	Y	Black	2-1318118-6			
	Z	Black	3-1318118-6			
16	X	Black	1-1318118-8	20.8	20.0	14.8
	Y	Black	2-1318118-8			
20	X	Black	1-1318118-9	25.8	20.0	14.8
	Y	Black	2-1318118-9			

■ Tab Housing

Panel type

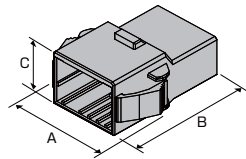

Pos	Key	Color	Part Number	Dimensions		
				A	B	C
6	X	Black	1-1318114-3	19.7	30.7	13.2
	Y	Black	2-1318114-3			
8	X	Black	1-1318114-4	22.2	30.7	13.2
	Y	Black	2-1318114-4			
12	X	Black	1-1318114-6	27.2	30.7	13.2
	Y	Black	2-1318114-6			
20	X	Black	1-1318114-9	37.2	30.7	13.2
	Y	Black	2-1318114-9			

NOTE: All products are RoHS compliant On selection.

■ Tab Housing

Free Hanging type

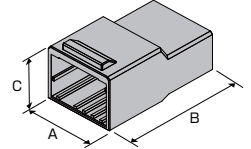

Pos	Key	Plating	Color	Part Number	Dimensions		
					A	B	C
6	X	Gold	Black	1-1318115-3	10.2	30.7	10.7
	Y	Gold	Black	2-1318115-3			
8	X	Gold	Black	1-1318115-4	12.7	30.7	10.7
	Y	Gold	Black	2-1318115-4			
12	X	Gold	Black	1-1318115-6	17.7	30.7	10.7
20	X	Gold	Black	1-1318115-9	27.7	30.7	10.7
	Y	Gold	Black	2-1318115-9			

■ Board-Mounting Header

Horizontal type

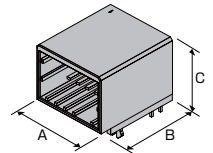

Pos	Key	Plating	Color	Part Number	Dimensions		
					A	B	C
6	X	Gold	Black	1376136-1	10.2	20.2	14.7
	Y	Gold	Black	1376136-2			
8	X	Gold	Black	1376009-1 1-1376009-1*	12.7	20.2	14.7
	Y	Gold	Black	1376009-2			
12	X	Gold	Black	1376020-1	17.7	20.2	14.7
	Y	Gold	Black	1376020-2			
20	X	Gold	Black	1376137-1	27.7	20.2	14.7
	Y	Gold	Black	1376137-2			

*Sequential

Vertical type

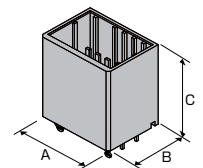

Pos	Key	Plating	Color	Part Number	Dimensions		
					A	B	C
6	X	Gold	Black	1318124-1	10.2	13.2	17.8
	Y	Gold	Black	1318124-2			
8	X	Gold	Black	1318125-1 1-1318125-1*	12.7	13.2	17.8
	Y	Gold	Black	1318125-2 1-1318125-2*			
12	X	Gold	Black	1318126-1 1-1318126-1*	17.7	13.2	17.8
	Y	Gold	Black	1318126-2 1-1318126-2*			
	Z	Gold	Black	1318126-3			
16	X	Gold	Black	1747994-1	22.7	13.2	17.8
	Y	Gold	Black	1747994-2			
20	X	Gold	Black	1318127-1	27.7	13.2	17.8
	Y	Gold	Black	1318127-2			

*Sequential

D-2100M Double-row Standard Multipostion Type (Drawer)

Type Chart

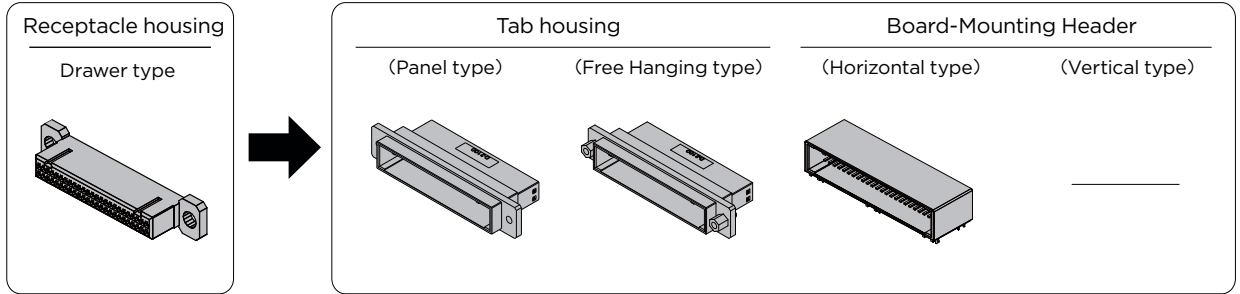

Pos	Color	Key	Receptacle housing		Tab housing		Plating	Board-Mounting Header	
			Type	Part Number	Panel type	Free Hanging type		Horizontal type	Vertical type
50	Black	—	Drawer	1318577-1	1318578-1 1318578-2 (with nuts)	—	Gold	1318579-1	—
	Black	—	Threaded drawer	1376072-2	—	1376073-2	—	—	—

Relative Product Information

Applicable contact...P.29
 Performance & Specifications ...P.27
 Accessories ...P.112

Mated Dimension

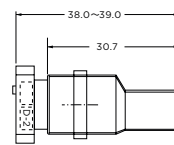

Panel type/Free Hanging type

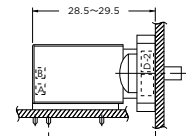

Horizontal type

External Dimensions

- Receptacle Housing
- Socket Accessories (with screws)

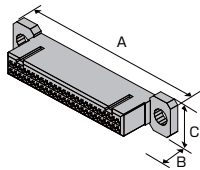

Pos	Key	Color	Part Number	Dimensions		
				A	B	C
50	—	Black	1318577-1	88.5	20.0	16.6
50	—	Black	1376072-2	88.5	32.0	16.6

■ Tab Housing

Panel type

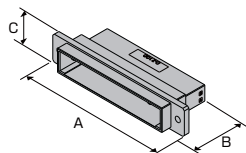

Pos	Key	Color	Part Number	Dimensions		
				A	B	C
50	—	Black	1318578-1	86.1	30.7	15.9
	—	Black	1318578-2(with nuts)			

NOTE: All products are RoHS compliant On selection.

■ Receptacle Assembly (with screws)

Free Hanging type

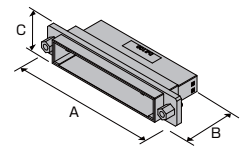

Pos	Key	Color	Part Number	Dimensions		
				A	B	C
50	—	Black	1376073-2	86.1	30.7	15.9

■ Board-Mounting Header

Horizontal type

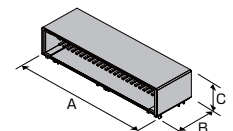

Pos	Key	Plating	Color	Part Number	Dimensions		
					A	B	C
50	—	Gold	Black	1318579-1	68.5	21.1	15.4

D-2600D Double-row Hybrid Type

Type Chart

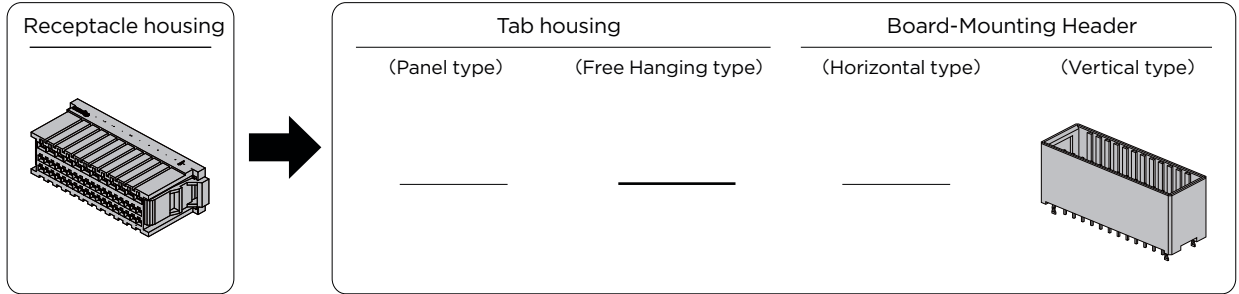

Pos	Color	Key	Receptacle housing	Tab housing		Plating	Board-Mounting Header	
				Panel type	Free Hanging type		Horizontal type	Vertical type
48*	Black	—	1827540-1	—	—	Gold	—	1827538-1

*36 D2000 contacts and 12 D3000 contacts are used in combination

Relative Product Information

Applicable contact...P.29, 39
Performance & Specifications ...P.27, 36

Mated Dimension

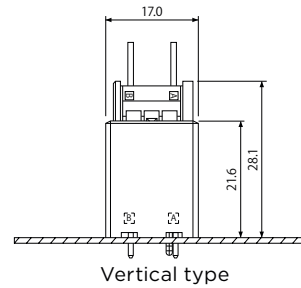

External Dimensions

Receptacle Housing

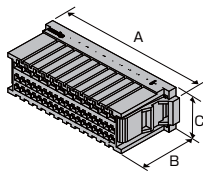

Pos	Key	Plating	Color	Part Number	Dimensions		
					A	B	C
48	—	—	Black	1827540-1	58.7	22.8	15.8

Board-Mounting Header

Vertical type

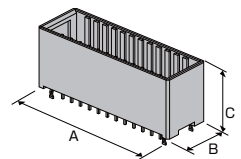

Pos	Key	Plating	Color	Part Number	Dimensions		
					A	B	C
48	—	Gold	Black	1827538-1	55.9	18.0	21.6

D-3000 Series

Series introduction

The 3000 series is the main Dynamic Series. They are widely used as industrial 'signal' and 'power' connectors.

Pin layout comes in three types: standard 3.81mm pitch, high voltage 5.08mm pitch type and 7.5mm spring clamp type.

The former one is used for signal circuits and the latter two are for high-voltage circuits.

For power source usage, it meets recent demands for small size and high power which comply with miniaturisation of the machinery. The newly developed copper alloy can carry a higher current of 15A per pole despite its small size.

This concept is based on the development strategy of the Dynamic Series to cover as wide a range of solutions for as many customers as possible. This concept makes the D-3000 series terminals fit all D-3000 housings, and the wide variety of which means that it is not necessary for a customer to look outside of this range for every requirement.

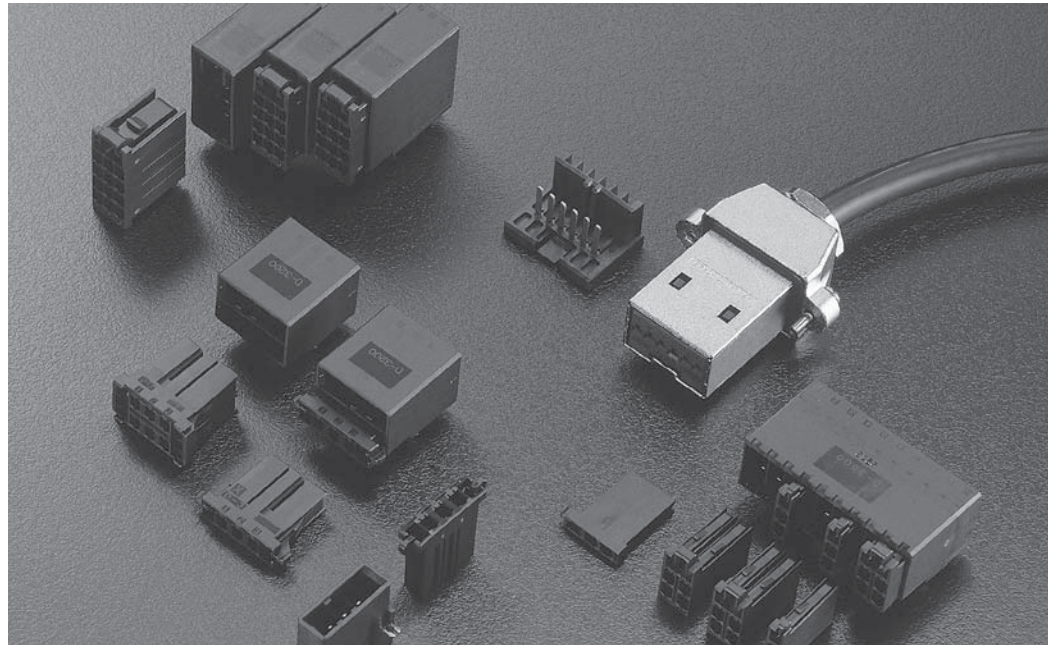

Product Features

1. Anti-twist contact structure

An anti-twist contact structure were developed for motor industry which has 3 contact points when mating receptacle contact with tab contact or header. Concept of 3-contact-points provides high reliability in a real-world environment.

2. Three plating types

3 Plating types are available to meet the customer's cost, performance requirements and applications. Under a normal environment with few mating/unmating requirements, tin plating can be used. Where there is a large number of mating/unmating requirements, then gold plating at 0.38 μm thickness should be used. If the environment is deleterious then gold plating at 0.76 μm thickness can be selected

3. Two types of contact pressure options

2 types of contact pressures are available depending on application: standard Contact pressure for withstanding a large number of mating/unmating requirements or other extreme environments, and high Contact pressure for vibration prone applications

4. High Current

Despite its small size, it conducts up to 15A (at a maximum temperature rise of 30°C). The latest developed copper alloy adds to the reliability of the 3-point contact structure

5. Audible Latching

When mating, a dear 'lock' sound and vibration will be felt by the assembler, that can prevent working 'blind' mis-mating (or halfmating) problems

6. Keying

The housing provides a keying (slit), hence mis-matings can be prevented by using the X and Y keys separately. At the same time, the keying plug can be used to create new key patterns.

3000 Series Performance and Specifications

Performance

Item \ Pitch	150mil (3.81mm)	200mil (5.08mm)
Rated Voltage	250V AC/DC	600V AC/DC
Rated Current	1 pole:15A 3 pole: 12A 6 pole: 9.5A 16 pole: 8A (AWG#16 for use as powersource)	
Contact resistance	Maximum: 10mff	
Withstanding Voltage	1,500V AC(1 min)	2,200V AC(1 min)
Temperature	-55-+105°C	

Positions/Wire Size/Rated Current

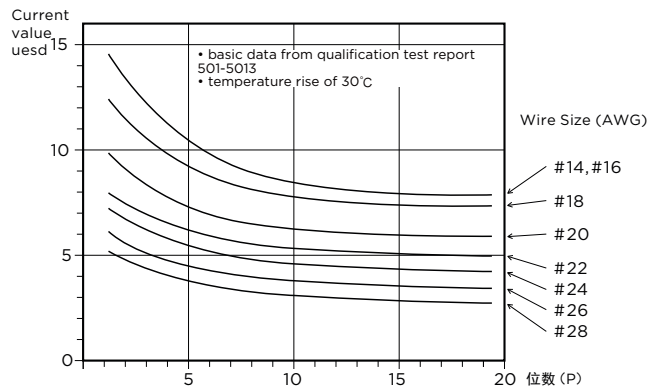

Performance & Specifications

Product Specifications	108-5349
Test Report	501-5013 501-78668(FMLB)
Applications Specifications	114-5148 114-78030(FMLB)
Pull tool product number (234168-1) manual	411-5726

Hand tool manual	
Tool product number	Instruction No.
91565-1 91559-1 91558-1 91560-1 91561-1	408-8547-1

Material and Plating

Category	Materials	Plating
Receptacle Contact Tab Contact	Copper alloys	Tin-plating or gold-plating over Nickel under-plated
Board Mount Header	Copper alloys	Tin-plating or gold-plating over Nickel under-plated
Housing	UL94V-0 thermoplastic PBT with glass fiber, PPS (SMT type), or liquid crystal polymer (motor connector), Black	

Please order the manual concurrently.

An E-Catalogue is also available for download from the internet

Safety Standards

The safety specifications listed below are approved on specific part numbers. Please contact our Technical Support Centre to check whether the part numbers you use are approved or not. Keep in mind that there are instances where values differ from those given by Tyco Electronics Specifications.

STD.	Series	D-3100 and D-3400 series (3.81mm pitch)			D-3200 and D-3500 series (5.08mm pitch)																																						
		Rated Voltage	Rated Current	Temperature Range	Rated Voltage	Rated Current	Temperature Range																																				
Product Specifications 108-5349		250V AC/DC	Above table	-55°C -+105°C	600V AC/DC	Above table	-55°C -+105°C																																				
UL File No.E28476 (Recognized Component)		Based on the requirements of Application	Based on the requirements of Application	-	Based on the requirements of Application	Based on the requirements of Application	-																																				
CSA Report No. LR7189		250V AC/DC	Maximum: 8A	-	250V AC/DC	Maximum: 8A	-																																				
TÜV License No. R9151488 (EN61984) IP protection level IP-00 Overvoltage type (II) 50 cycles of repeated plugging and unplugging		250V AC 300V DC	<table border="1"> <thead> <tr> <th>AWG</th> <th>A</th> </tr> </thead> <tbody> <tr><td>28</td><td>2</td></tr> <tr><td>26</td><td>3</td></tr> <tr><td>24</td><td>3</td></tr> <tr><td>22</td><td>4</td></tr> <tr><td>20</td><td>5</td></tr> <tr><td>18</td><td>6</td></tr> <tr><td>16</td><td>8</td></tr> <tr><td>14</td><td>8</td></tr> </tbody> </table>	AWG	A	28	2	26	3	24	3	22	4	20	5	18	6	16	8	14	8	-20°C -+105°C	400V AC 300V DC	<table border="1"> <thead> <tr> <th>AWG</th> <th>A</th> </tr> </thead> <tbody> <tr><td>28</td><td>2</td></tr> <tr><td>26</td><td>3</td></tr> <tr><td>24</td><td>3</td></tr> <tr><td>22</td><td>4</td></tr> <tr><td>20</td><td>5</td></tr> <tr><td>18</td><td>6</td></tr> <tr><td>16</td><td>8</td></tr> <tr><td>14</td><td>8</td></tr> </tbody> </table>	AWG	A	28	2	26	3	24	3	22	4	20	5	18	6	16	8	14	8	-20°C -+105°C
AWG	A																																										
28	2																																										
26	3																																										
24	3																																										
22	4																																										
20	5																																										
18	6																																										
16	8																																										
14	8																																										
AWG	A																																										
28	2																																										
26	3																																										
24	3																																										
22	4																																										
20	5																																										
18	6																																										
16	8																																										
14	8																																										
Same as above Overvoltage type (III)		-	Same as above	Same as above	250V AC 300V DC	Same as above	Same as above																																				



D-3000 Series Configurations

All connector forms are provided, from the wire-to-wire panel type and free hanging type to the wire-to-board horizontal type and vertical type. Each position can carry a maximum current of up to 15A.

D-3100S Single-row

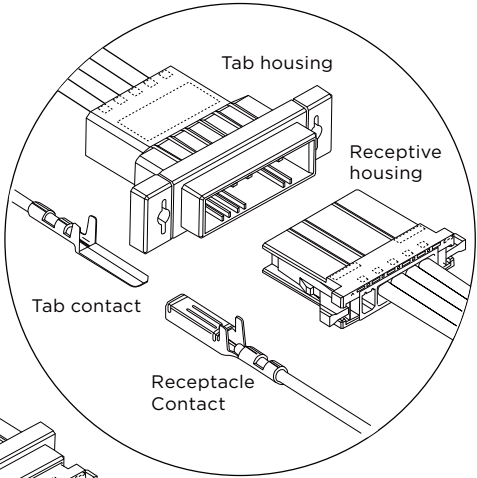

D-3100S
Free Hanging type
(P.40)

D-3100M Standard Modular

D-3100M
PCB mounted
vertical type
(P.46)

D-3100M
PCB Mounted horizontal type
(P.46)

D-3100S
PCB mounted
Vertical type
(P.40)

D-3100S
Panel type
(P.40)

D-3100S PCB Mounted horizontal type
(P.40)

D-3100S SMT
PCB mounted
vertical type
(P.43)

D-3100S SMT
PCB Mounted
horizontal type
(P.43)

Surface mount type
with altered
retention leg shape
and housing
material

D-3100D
PCB Mounted
horizontal type
(P.44)

D-3100D
Free Hanging type
(P.44)

D-3100D Panel type
(P.44)

D-3100D PCB Mounted horizontal type
(P.44)

D-3100D Double-row

All the same forms as
the single-row
standard



D-3000 Series Configurations

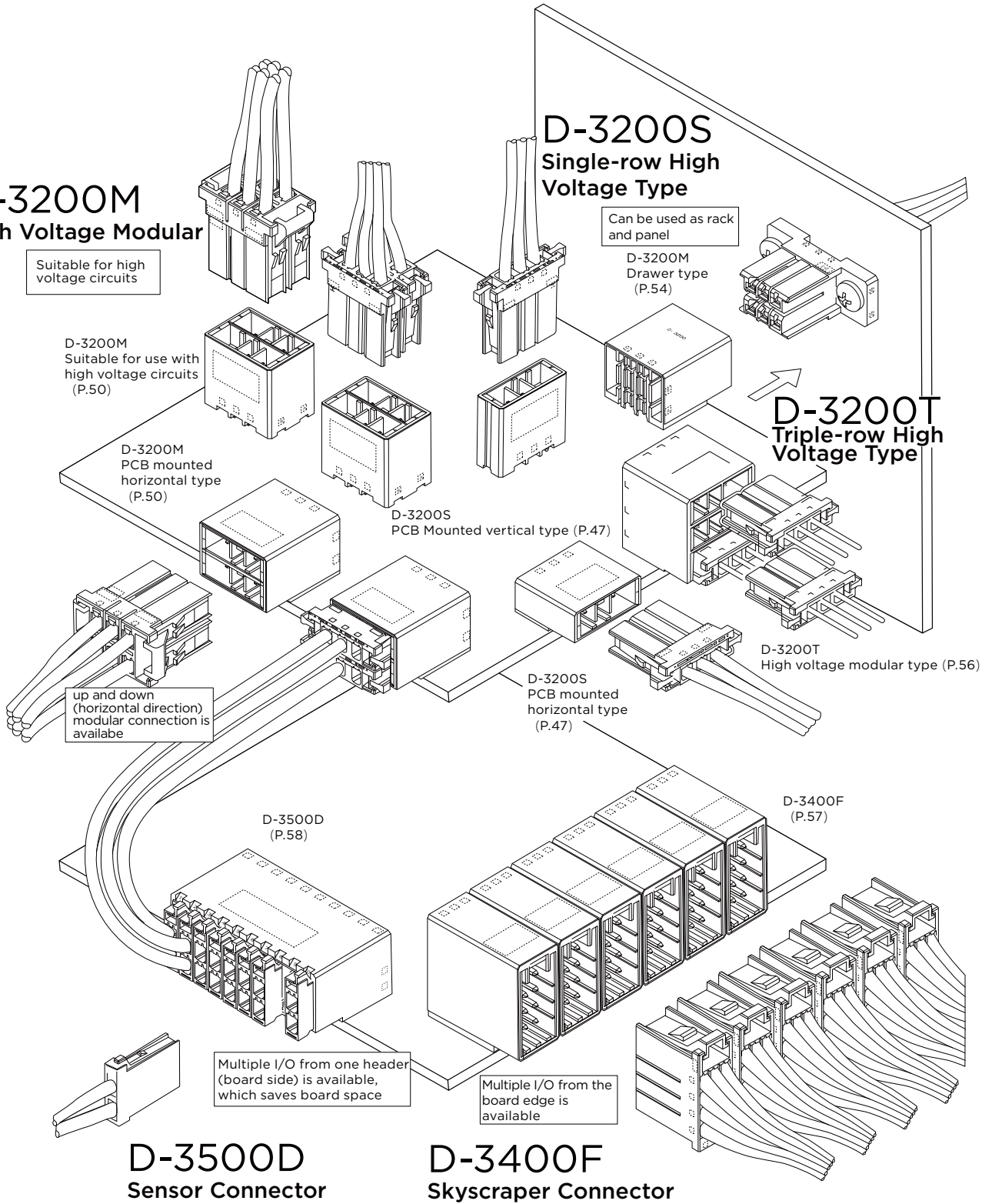

D-3000 Series Contact

■ Crimped Types

Receptacle Contact
(used in receptacle housing)

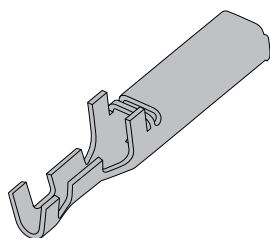

Tab contact
(used in tab housing)

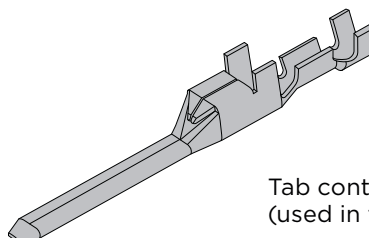

Wire Range		Outside Diameter of Insulation mm	Wire Range Mark	Contacts					Applicable tools	
AWG	mm ²			Receptacle Contact			Tab Contact		CCII Hand Tool PEW12 Hand Tool* (PEW12 dice only)	Mini Applicator
					Strip form	Loose Piece	Strip form	Loose Piece		
28 26	0.08 0.12	0.8-1.2	S	Standard contact pressure (gold plating only)	175194-□ 2298107-1"	175216-□ 2311162-1"	175284-□	175287-□	91565-1	2836130-1
24	0.20	1.0-1.4		High contact pressure	1-175194-□	1-175216-□				
24 22 20	0.20 0.30 0.50	1.2-1.6 1.7-2.6 (1.7-2.35)**	M	Standard contact pressure (gold plating only)	175195-□ 2298107-2"	175217-□ 2311162-2" FMLB	175285-□	175288-□	91559-1	2151080-1
				High contact pressure	1-175195-□	1-175217-□				
20 18	0.50 0.85	1.8-2.8	L	Standard contact pressure (gold plating only)	175196-□ 2298107-3"	175218-□ 2311162-3"	175286-□	175289-□	91558-1	2151018-1
16	1.25	2.2-2.8 (2.2-2.56)**		High contact pressure	1-175196-□	1-175218-□				
16 14	1.25 2.20	2.2-2.8	2L	Standard contact pressure (gold plating only)	917484-□ 2298107-4"	917511-□ 2311162-4"	917485-□	917512-□	91560-1	2151119-1
				High contact pressure	1-917484-□	1-917511-□				
16 14	1.25 2.20	3.1-3.3 3.3-3.8	3L	Standard contact pressure (gold plating only)	353715-□ 2298107-5"	353717-□ 2311162-5"	353716-□	353718-□	91561-1	2151073-1
				High contact pressure	1-353715-□	1-353717-□				

Reference: Plating code

-2: 0.38 μm thickness gold plating

-3: 0.76 μm thickness gold plating

-5: Tin plating (only set to the high contact pressure type)

Strip Form contacts are used with Mini-applicators (bench machine) and Loose-Piece contacts are with hand tools.

Please see 114-5148 for strip form products

* The outer diameter of the insulation is applicable to Loose Piece terminals.

**Sequential (FMLB) female contacts. See 114-78030 in the operating manual.

The receptacle contact can be used in all receptacle housings, while the Tab housing can be used in all tabs housings Details of the applicable tool are available from P.107

NOTE: all products are RoHS compliant On selection.

D-3100S Single-row Standard

Type Chart

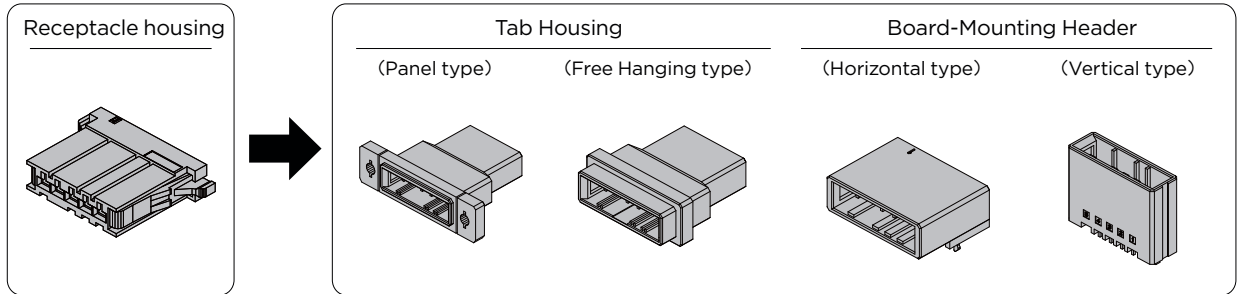

Pos	Color	Key	Receptacle housing	Tab housing			Plating	Board-Mounting Header	
				Panel type	Free Hanging type	L Bracket		Horizontal type	Vertical type
2	Black	X	1-178128-2	1-179553-2	1-179552-2	S	Gold	1-179276-2	1-917337-2
							Gold	1-179276-3	1-917337-3
							Tin	1-179276-5	1-917337-5
	Black	Y	2-178128-2	2-179553-2	2-179552-2	S	Gold	2-179276-2	2-917337-2
							Gold	2-179276-3	2-917337-3
						Tin	—	2-917337-5	
3	Black	X	1-178288-3	1-178802-3	1-177648-3	S	Gold	1-178293-2	1-178313-2
							Gold	1-178293-3	1-178313-3
							Tin	1-178293-5	1-178313-5
	Black	Y	2-178288-3	2-178802-3	2-177648-3	S	Gold	2-178293-2	2-178313-2
							Gold	2-178293-3	2-178313-3
							Tin	2-178293-5	2-178313-5
	Black	Z	3-178128-3	—	—	—	Tin	—	3-178136-5
4	Black	X	1-178288-4	1-179553-4	1-179552-4*	—	Gold	1-178294-2	1-178314-2
							Gold	1-178294-3	1-178314-3
							Tin	1-178294-5	1-178314-5
	Black	Y	2-178288-4	2-179553-4	2-179552-4*	—	Gold	2-178294-2	2-178314-2
							Gold	2-178294-3	2-178314-3
						Tin	2-179277-5	2-178314-5	
5	Black	X	1-178288-5	1-178802-5	1-177648-5	L	Gold	1-178295-2	1-178315-2
							Gold	1-178295-3	1-178315-3
							Tin	1-178295-5	1-178315-5
6	Black	X	1-178288-6	—	—	—	Gold	1-178296-2	1-178316-2
							Gold	1-178296-3	1-178316-3
							Tin	1-178296-5	1-178316-5
	Black	Y	2-178288-6	—	—	—	Gold	2-178296-2	2-178316-2
							Gold	—	2-178316-3
						Tin	—	2-178316-5	
8	Black	X	1-178288-7	1-178802-7	1-177648-7	L	Gold	1-178297-2	1-178317-2
							Gold	1-178297-3	1-178317-3
							Tin	1-178297-5	1-178317-5
10	Black	X	1-178288-8	1-178802-8	1-177648-8	L	Gold	1-178298-2	1-178318-2
							Gold	1-178298-3	1-178318-3
							Tin	1-178298-5	1-178318-5
	Black	Y	2-178288-8	2-178802-8	2-177648-8	L	Gold	2-178298-3	2-178318-2

*DIN rail attachment is available, P/N 2822900-1

Relative Product Information

Applicable contact...P.39
 Performance & Specifications...P.36
 Accessories...P.112

NOTE: all products are RoHS compliant On selection.

Mated Dimension

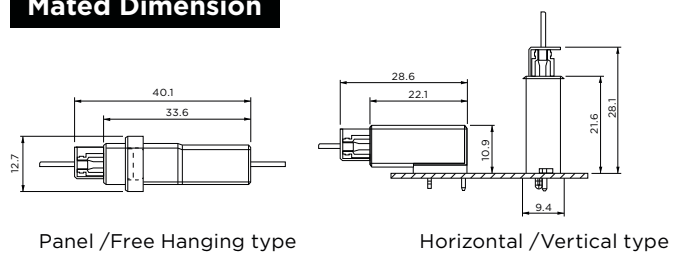

D-3100S Single-row Standard

External Dimensions

■ Receptacle Housing

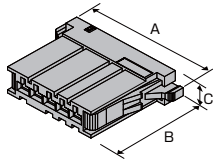

Pos	Key	Color	Part Number	Dimensions		
				A	B	C
2	X	Black	1-178128-2	24.6	22.8	7.2
	Y	Black	2-178128-2			
3	X	Black	1-178288-3	26.8	22.8	7.2
	Y	Black	2-178288-3			
	Z	Black	3-178128-3			
4	X	Black	1-178288-4	30.6	22.8	7.2
5	Y	Black	2-178288-4	34.4	22.8	7.2
6	X	Black	1-178288-6	38.2	22.8	7.2
8	Y	Black	2-178288-6	45.8	22.8	7.2
10	X	Black	1-178288-8	53.4	22.8	7.2
	Y	Black	2-178288-8			

■ Tab Housing

Panel type

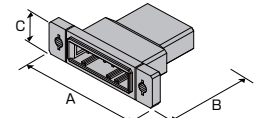

Pos	Key	Color	Part Number	Dimensions		
				A	B	C
2	X	Black	1-179553-2	36.8	33.6	12.7
	Y	Black	2-179553-2			
3	X	Black	1-178802-3	40.0	33.6	12.7
	Y	Black	2-178802-3			
4	X	Black	1-179553-4	47.0	33.6	12.7
	X	Black	2-179553-4			
5	X	Black	1-178802-5	47.0	33.6	12.7
8	X	Black	1-178802-7	59.0	33.6	12.7
10	X	Black	1-178802-8	67.0	33.6	12.7
	Y	Black	2-178802-8			

Free Hanging type

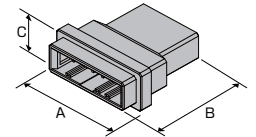

Pos	Key	Color	Part Number	Dimensions		
				A	B	C
2	X	Black	1-179552-2	23.0	33.6	12.7
	Y	Black	2-179552-2			
3	X	Black	1-177648-3	25.6	33.6	12.7
	Y	Black	2-177648-3			
4	X	Black	1-179552-4	33.2	33.6	12.7
	X	Black	2-179552-4			
5	X	Black	1-177648-5	33.2	33.6	12.7
8	X	Black	1-177648-7	44.6	33.6	12.7
10	X	Black	1-177648-8	52.2	33.6	12.7
	Y	Black	2-177648-8			

Applications

Example of elevator applications

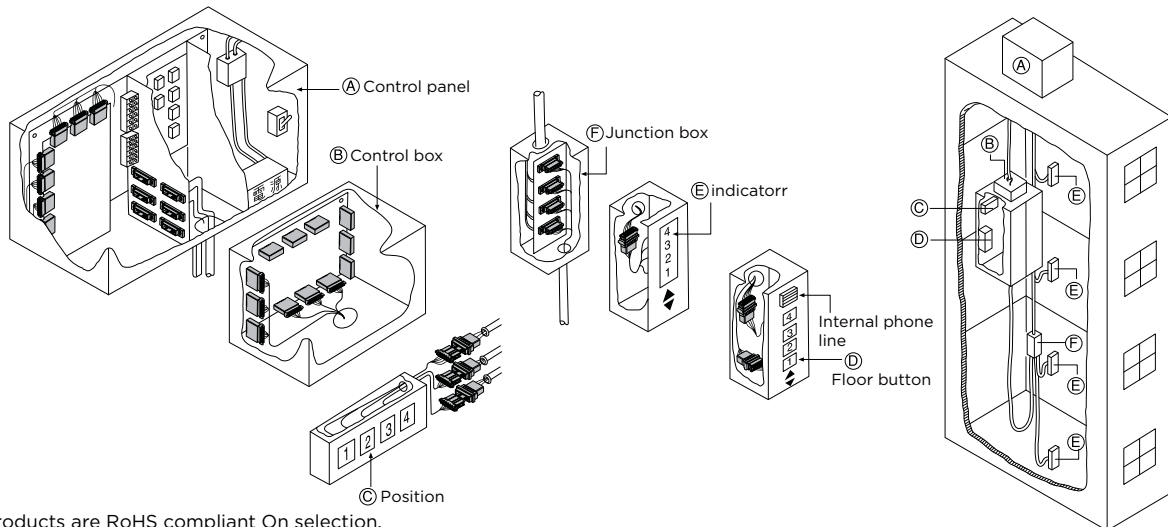

NOTE: all products are RoHS compliant On selection.

D-3100S Single-row Standard

Board-Mounting Header

Horizontal type

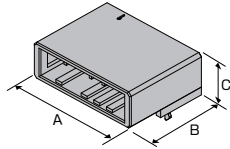

Pos	Key	Plating	Color	Part Number	Dimensions		
					A	B	C
2	X	Gold	Black	1-179276-2	19.1	22.1	10.9
		Gold	Black	1-179276-3			
		Tin	Black	1-179276-5			
	Y	Gold	Black	2-179276-2			
		Gold	Black	2-179276-3			
3	X	Gold	Black	1-178293-2	21.6	22.1	10.9
		Gold	Black	1-178293-3			
		Tin	Black	1-178293-5			
	Y	Gold	Black	2-178293-2			
		Gold	Black	2-178293-3			
		Tin	Black	2-178293-5			
4	X	Gold	Black	1-178294-2	25.4	22.1	10.9
		Gold	Black	1-178294-3			
		Tin	Black	1-178294-5			
	Y	Gold	Black	2-178294-2			
5	X	Gold	Black	1-178295-2	29.2	22.1	10.9
		Gold	Black	1-178295-3			
		Tin	Black	1-178295-5			
6	X	Gold	Black	1-178296-2	33.1	22.1	10.9
		Gold	Black	1-178296-3			
		Tin	Black	1-178296-5			
	Y	Gold	Black	2-178296-2			
8	X	Gold	Black	1-178297-2	40.7	22.1	10.9
		Gold	Black	1-178297-3			
		Tin	Black	1-178297-5			
		Gold	Black	1-178298-2			
10	X	Gold	Black	1-178298-3	48.3	22.1	10.9
		Tin	Black	1-178298-5			
		Gold	Black	2-178298-3			
	Y	Gold	Black	2-178298-3			
		Gold	Black	2-178298-3			

Board-Mounting Header

Vertical type

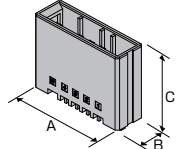

Pos	Key	Plating	Color	Part Number	Dimensions		
					A	B	C
2	X	Gold	Black	1-917337-2	19.1	9.4	21.6
		Gold	Black	1-917337-3			
		Tin	Black	1-917337-5			
	Y	Gold	Black	2-917337-2			
		Gold	Black	2-917337-3			
3	X	Gold	Black	1-178313-2	21.6	9.4	21.6
		Gold	Black	1-178313-3			
		Tin	Black	1-178313-5			
	Y	Gold	Black	2-178313-2			
		Gold	Black	2-178313-3			
		Tin	Black	2-178313-5			
4	X	Tin	Black	3-178136-5	25.4	9.4	21.6
		Gold	Black	1-178314-2			
		Gold	Black	1-178314-3			
	Y	Tin	Black	1-178314-5			
Gold		Black	2-178314-2				
5	X	Gold	Black	1-178314-3	29.2	9.4	21.6
		Gold	Black	1-178314-5			
		Gold	Black	2-178314-2			
		Gold	Black	2-178314-3			
6	X	Tin	Black	2-178314-5	33.1	9.4	21.6
		Gold	Black	1-178315-2			
		Gold	Black	1-178315-3			
	Y	Tin	Black	1-178315-5			
		Gold	Black	1-178316-2			
8	X	Gold	Black	1-178316-3	40.7	9.4	21.6
		Gold	Black	1-178316-5			
		Tin	Black	1-178316-5			
	Y	Gold	Black	2-178316-2			
		Gold	Black	2-178316-3			
10	X	Tin	Black	2-178316-5	48.3	9.4	21.6
		Gold	Black	1-178317-2			
		Gold	Black	1-178317-3			
	Y	Tin	Black	1-178317-5			
		Gold	Black	2-178318-2			

NOTE: all products are RoHS compliant On selection.



D-3100S Single-row SMT Types

Type Chart

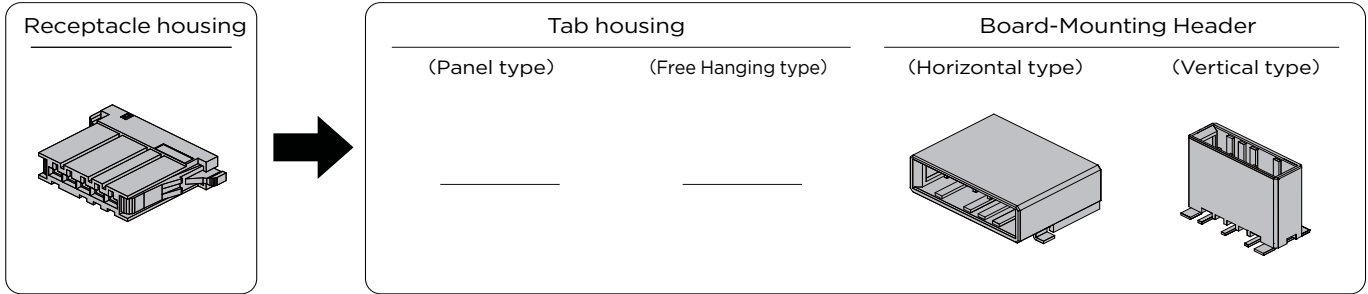

Pos	Color	Key	Receptacle housing	Tab housing		Plating	Board-Mounting Header	
				Panel type	Free Hanging type		Horizontal type	Vertical type
5	Black	X	1-178288-5	—	—	Gold	1-177662-2	1-177665-2
							1-2343327-2*	
8	Black	X	1-178288-7	—	—	Gold	1-179188-2	—
							1-179188-3	

* In reel package

Mated Dimension

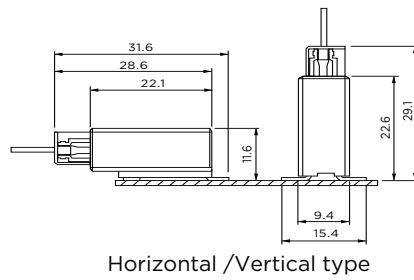

External Dimensions

Receptacle Housing

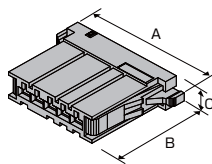

Pos	Key	Color	Part Number	Dimensions		
				A	B	C
5	X	Black	1-178288-5	34.4	22.8	7.2
8	X	Black	1-178288-7	45.8	22.8	7.2

Board-Mounting Header

Horizontal type

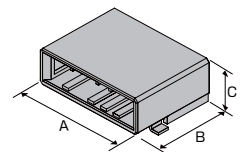

Pos	Key	Plating	Color	Part Number	Dimensions		
					A	B	C
5	X	Gold	Black	1-177662-2	29.2	22.1	11.6
8	X	Gold	Black	1-179188-2	40.7	22.1	11.6
		Gold	Black	1-179188-3			

Vertical type

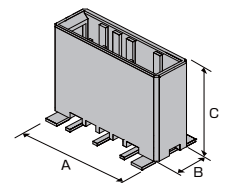

Pos	Key	Plating	Color	Part Number	Dimensions		
					A	B	C
5	X	Gold	Black	1-177665-2	29.2	9.4	22.6

NOTE: all products are RoHS compliant On selection.



D-3100D Double-row Standard Type

Type Chart

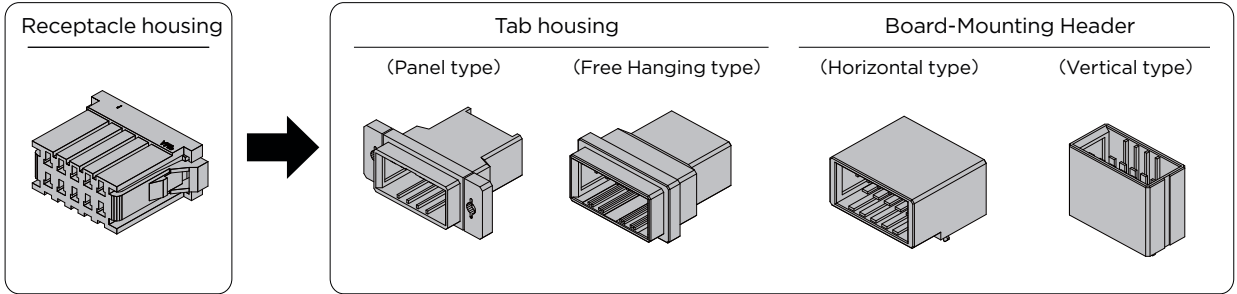

Pos	Color	Key	Receptacle housing	Tab housing			Plating	Board-Mounting Header	
				Panel type	Free Hanging type	L Bracket		Horizontal type	Vertical type
6	Black	X	178289-3	178803-3	178964-3	S	Gold	178303-2	178323-2
							Gold	178303-3	178323-3
							Tin	178303-5	178323-5
8	Black	X	178289-4	—	178964-4	S	Gold	1717412-2	1903601-2
							Tin	1717412-3	—
10	Black	X	178289-5	178803-5	178964-5	L	Gold	178305-2	178325-2
							Gold	178305-3	178325-3
							Tin	178305-5	178325-5
12	Black	X	178289-6	178803-6	178964-6	L	Gold	178306-2	178326-2
							Gold	178306-3	178326-3
							Tin	178306-5	178326-5
16	Black	X	178289-7	178803-7	178964-7	L	Gold	178307-2	178327-2
							Gold	178307-3	178327-3
							Tin	178307-5	178327-5
20	Black	X	178289-8	178803-8	178964-8	L	Gold	178308-2	178328-2
							Gold	178308-3	178328-3
							Tin	178308-5	178328-5

Relative Product Information

Applicable contact...P.39
 Performance & Specifications...P.36
 Accessories...P.112

Mated Dimension

Panel/Free Hanging type Horizontal/Vertical type

Applications

Example of Programmable Controller Application

NOTE: all products are RoHS compliant On selection.

D-3100D Double-row Standard Type

External Dimensions

■ Receptacle Housing

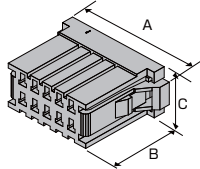

Pos	Key	Color	Part Number	Dimensions		
				A	B	C
6	X	Black	178289-3	24.4	22.8	12.5
8	X	Black	178289-4	28.2	22.8	12.5
10	X	Black	178289-5	32.0	22.8	12.5
12	X	Black	178289-6	35.8	22.8	12.5
16	X	Black	178289-7	42.7	22.8	12.5
20	X	Black	178289-8	51.0	22.8	12.5

■ Tab Housing

Panel type

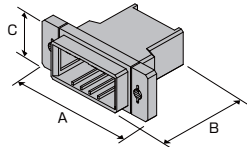

Pos	Key	Color	Part Number	Dimensions		
				A	B	C
6	X	Black	178803-3	40.0	33.6	17.8
10	X	Black	178803-5	47.0	33.6	17.8
12	X	Black	178803-6	51.0	33.6	17.8
16	X	Black	178803-7	59.0	33.6	17.8
20	X	Black	178803-8	67.0	33.6	17.8

Free Hanging type

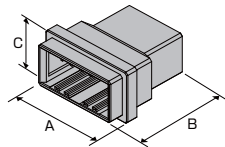

Pos	Key	Color	Part Number	Dimensions		
				A	B	C
6	X	Black	178964-3	25.6	33.6	17.8
8	X	Black	178964-4	29.4	33.6	17.8
10	X	Black	178964-5	33.2	33.6	17.8
12	X	Black	178964-6	37.0	33.6	17.8
16	X	Black	178964-7	44.6	33.6	17.8
20	X	Black	178964-8	52.2	33.6	17.8

NOTE: all products are RoHS compliant On selection.

■ Board-Mounting Header

Horizontal type

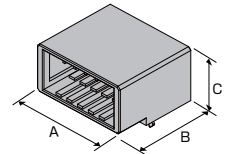

Pos	Key	Plating	Color	Part Number	Dimensions		
					A	B	C
6	X	Gold	Black	178303-2	21.6	25.9	15.9
	X	Gold	Black	178303-3			
	X	Tin	Black	178303-5			
8	X	Gold	Black	1717412-2	25.4	25.9	15.9
	X	Gold	Black	1717412-3			
10	X	Gold	Black	178305-2	29.2	25.9	15.9
	X	Gold	Black	178305-3			
	X	Tin	Black	178305-5			
12	X	Gold	Black	178306-2	33.1	25.9	15.9
	X	Gold	Black	178306-3			
	X	Tin	Black	178306-5			
16	X	Gold	Black	178307-2	40.7	25.9	15.9
	X	Gold	Black	178307-3			
	X	Tin	Black	178307-5			
20	X	Gold	Black	178308-2	48.3	25.9	15.9
	X	Gold	Black	178308-3			
	X	Tin	Black	178308-5			

Vertical type

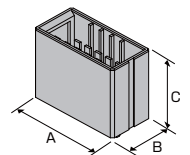

Pos	Key	Plating	Color	Part Number	Dimensions		
					A	B	C
6	X	Gold	Black	178323-2	21.6	14.4	21.6
	X	Gold	Black	178323-3			
	X	Tin	Black	178323-5			
8	X	Gold	Black	1903601-2	25.4	14.4	21.6
	X	Tin	Black	1903601-5			
10	X	Gold	Black	178325-2	29.2	14.4	21.6
	X	Tin	Black	178325-5			
12	X	Gold	Black	178326-2	33.1	14.4	21.6
	X	Tin	Black	178326-5			
16	X	Gold	Black	178327-2	40.7	14.4	21.6
	X	Gold	Black	178327-3			
	X	Tin	Black	178327-5			
20	X	Gold	Black	178328-2	48.3	14.4	21.6
	X	Gold	Black	178328-3			
	X	Tin	Black	178328-5			

D-3100M Double-row Standard Modular Type

Type Chart

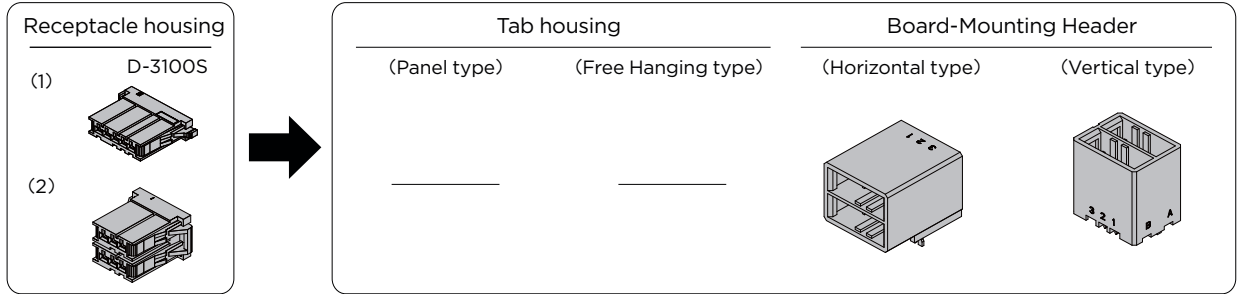

Pos	Color	Key	Receptacle housing		Tab housing		Plating	Board-Mounting Header	
			1 row 3 pos.1	1 row 6 pos.	Panel type	Free Hanging type		Horizontal type	Vertical type
6	Black	XX	1-178288-3 (2)	1-178127-6 (1)	—	—	Gold	1-178137-2	1-178141-2
					—	—	Gold	1-178137-3	1-178141-3
					—	—	Tin	1-178137-5	1-178141-5
	Black	YY	2-178288-3 (2)	2-178127-6 (1)	—	—	Gold	2-178137-2	—
					—	—	Tin	2-178137-5	—
					—	—	—	—	—
Black	XY	1-178288-3 (1) 2-178288-3 (1)	3-178127-6 (1)	—	—	Gold	3-178137-2	3-178141-2	
				—	—	Gold	3-178137-3	3-178141-3	
				—	—	Tin	3-178137-5	3-178141-5	

Relative Product Information

Applicable contact...P.39
Performance & Specifications ...P.36

Mated Dimension

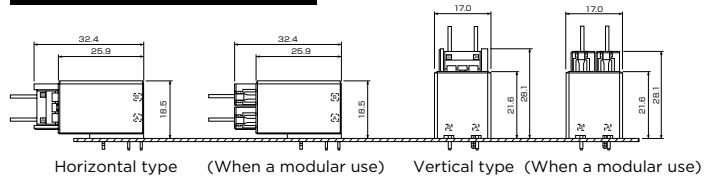

External Dimensions

Receptacle Housing

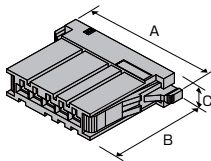

Pos	Key	Color	Part Number	Dimensions		
				A	B	C
3	X	Black	1-178288-3	26.8	22.8	7.2
	Y	Black	2-178288-3			

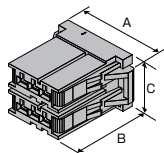

Pos	Key	Color	Part Number	Dimensions		
				A	B	C
6	XX	Black	1-178127-6	24.8	22.8	14.8
	YY	Black	2-178127-6			
	XY	Black	3-178127-6			

NOTE: all products are RoHS compliant On selection.

Board-Mounting Header

Horizontal type

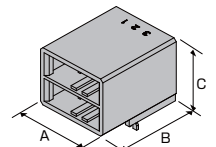

Pos	Key	Plating	Color	Part Number	Dimensions		
					A	B	C
6	XX	Gold	Black	1-178137-2	21.6	25.9	18.5
		Gold	Black	1-178137-3			
		Tin	Black	1-178137-5			
	YY	Gold	Black	2-178137-2			
		Tin	Black	2-178137-5			
		XY	Gold	Black			
Gold	Black		3-178137-3				
Tin	Black		3-178137-5				

Vertical type

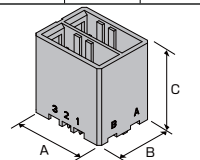

Pos	Key	Plating	Color	Part Number	Dimensions		
					A	B	C
6	XX	Gold	Black	1-178141-2	21.6	17.0	21.6
		Gold	Black	1-178141-3			
		Tin	Black	1-178141-5			
	XY	Gold	Black	3-178141-2			
		Gold	Black	3-178141-3			
		Tin	Black	3-178141-5			

D-3200S Single-row High Voltage Type

Type Chart

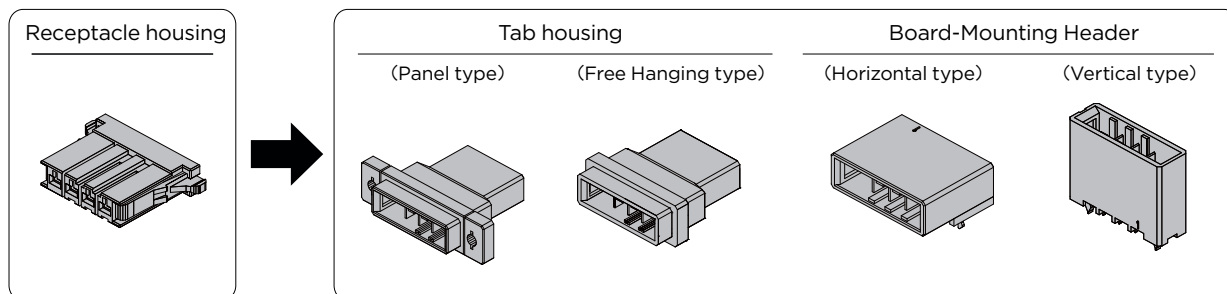

Pos	Color	Key	Receptacle housing	Tab housing			Plating	Board-Mounting Header	
				Panel type	Free Hanging type	L Bracket		Horizontal type	Vertical type
2	Black	X	1-178128-2	1-179553-2	1-179552-2	S	Gold	1-179276-2	1-917337-2
							Gold	1-179276-3	1-917337-3
	Black	Y	2-178128-2	2-179553-2	2-179552-2	S	Tin	1-179276-5	1-917337-5
							Gold	2-179276-2	2-917337-2
3	Black	X	1-178128-3	1-179553-3	1-179552-3	S	Gold	1-178138-2	1-178136-2
							Gold	1-178138-3	1-178136-3
							Tin	1-178138-5	1-178136-5
	Black	Y	2-178128-3	2-179553-3	2-179552-3	S	Gold	2-178138-2	2-178136-2
							Gold	2-178138-3	2-178136-3
							Tin	2-178138-5	2-178136-5
Black	Z	3-178128-3	—	—	—	Tin	—	3-178136-5	
			4	Black	X	1-178128-4	1-179553-4	1-179552-4	S
Gold	1-179277-3	1-917338-3							
Tin	1-179277-5	1-917338-5							
Black	Y	2-178128-4		2-179553-4	2-179552-4	S	Gold	2-179277-2	2-917338-2
							Gold	2-179277-3	2-917338-3
							Tin	2-179277-5	2-917338-5
5	Black	X	1-178128-5	—	—	—	Gold	1-316130-2	1-316132-2
							Gold	1-316130-3	1-316132-3
	Black	Y	2-178128-5	—	—	—	Tin	1-316130-5	1-316132-5
							Gold	2-316130-2	2-316132-2
6	Black	X	1-178128-6	—	—	—	Gold	2-316130-3	2-316132-3
							Gold	1-316131-2	1-316133-2
							Tin	1-316131-3	1-316133-3
	Black	Y	2-178128-6	—	—	—	Gold	1-316131-5	1-316133-5
							Gold	2-316131-2	2-316133-2
							Tin	2-316131-5	—

Relative Product Information

Applicable contact...P.39

Performance & Specifications ...P.36

Accessories ...P.112

NOTE: all products are RoHS compliant On selection.

D-3200S Single-row High Voltage Type

Mated Dimension

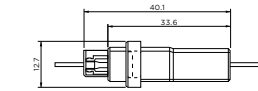

Panel /Free Hanging type

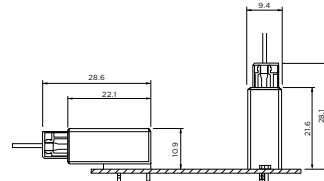

Horizontal /Vertical type

External Dimensions

■ Receptacle Housing

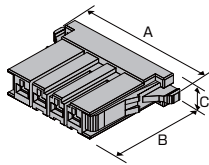

Pos	Key	Color	Part Number	Dimensions		
				A	B	C
2	X	Black	1-178128-2	24.6	22.8	7.2
	Y	Black	2-178128-2			
3	X	Black	1-178128-3	29.7	22.8	7.2
	Y	Black	2-178128-3			
	Z	Black	3-178128-3			
4	X	Black	1-178128-4	34.8	22.8	7.2
	Y	Black	2-178128-4			
5	X	Black	1-178128-5	39.9	22.8	7.2
	Y	Black	2-178128-5			
6	X	Black	1-178128-6	45.0	22.8	7.2
	Y	Black	2-178128-6			

■ Tab Housing

Panel type

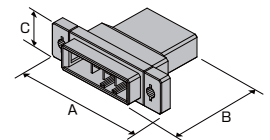

Pos	Key	Color	Part Number	Dimensions		
				A	B	C
2	X	Black	1-179553-2	36.8	33.6	12.7
	Y	Black	2-179553-2			
3	X	Black	1-179553-3	41.9	33.6	12.7
	Y	Black	2-179553-3			
4	X	Black	1-179553-4	47.0	33.6	12.7
	Y	Black	2-179553-4			

Free Hanging type

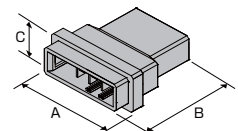

Pos	Key	Color	Part Number	Dimensions		
				A	B	C
2	X	Black	1-179552-2	23.0	33.6	12.7
	Y	Black	2-179552-2			
3	X	Black	1-179552-3	28.1	33.6	12.7
	Y	Black	2-179552-3			
4	X	Black	1-179552-4	33.2	33.6	12.7
	Y	Black	2-179552-4			

NOTE: all products are RoHS compliant On selection.

D-3200S Single-row High Voltage Type

Board-Mounting Header

Horizontal type

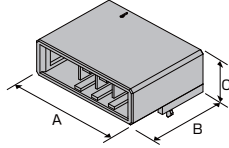

Pos	Key	Plating	Color	Part Number	Dimensions		
					A	B	C
2	X	Gold	Black	1-179276-2	19.1	22.1	10.9
		Gold	Black	1-179276-3			
		Tin	Black	1-179276-5			
	Y	Gold	Black	2-179276-2			
		Gold	Black	2-179276-3			
3	X	Gold	Black	1-178138-2	24.2	22.1	10.9
		Gold	Black	1-178138-3			
		Tin	Black	1-178138-5			
	Y	Gold	Black	2-178138-2			
		Tin	Black	2-178138-5			
4	X	Gold	Black	1-179277-2	29.2	22.1	10.9
		Gold	Black	1-179277-3			
		Tin	Black	1-179277-5			
	Y	Gold	Black	2-179277-2			
		Tin	Black	2-179277-5			
5	X	Gold	Black	1-316130-2	34.3	22.1	10.9
		Gold	Black	1-316130-3			
		Tin	Black	1-316130-5			
	Y	Gold	Black	2-316130-2			
		Gold	Black	2-316130-3			
6	X	Gold	Black	1-316131-2	39.4	22.1	10.9
		Gold	Black	1-316131-3			
		Tin	Black	1-316131-5			
	Y	Gold	Black	2-316131-2			
		Tin	Black	2-316131-5			

Board-Mounting Header

Vertical type

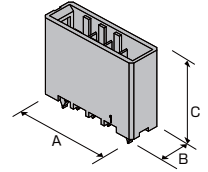

Pos	Key	Plating	Color	Part Number	Dimensions		
					A	B	C
2	X	Gold	Black	1-917337-2	19.1	9.4	21.6
		Gold	Black	1-917337-3			
		Tin	Black	1-917337-5			
	Y	Gold	Black	2-917337-2			
		Tin	Black	2-917337-5			
3	X	Gold	Black	1-178136-2	24.2	9.4	21.6
		Gold	Black	1-178136-3			
		Tin	Black	1-178136-5			
	Y	Gold	Black	2-178136-2			
		Tin	Black	2-178136-5			
4	X	Gold	Black	1-917338-2	29.2	9.4	21.6
		Gold	Black	1-917338-3			
		Tin	Black	1-917338-5			
	Y	Gold	Black	2-917338-2			
		Tin	Black	2-917338-5			
5	X	Gold	Black	1-316132-2	34.3	9.4	21.6
		Gold	Black	1-316132-3			
		Tin	Black	1-316132-5			
	Y	Gold	Black	2-316132-2			
		Gold	Black	2-316132-3			
6	X	Gold	Black	1-316133-2	39.4	9.4	21.6
		Gold	Black	1-316133-3			
		Tin	Black	1-316133-5			
	Y	Gold	Black	2-316133-2			
		Gold	Black	2-316133-3			

NOTE: all products are RoHS compliant On selection.



D-3200M Double-row High Voltage Types

Type Chart

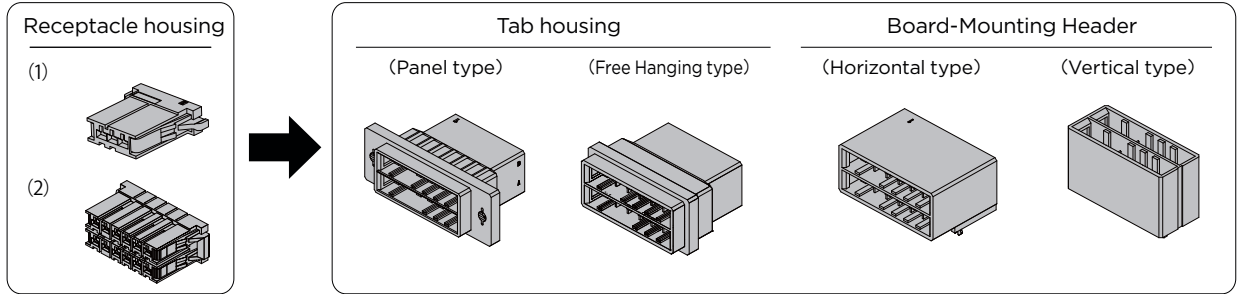

Pos	Color	Key	Receptacle housing (2)	Tab housing			Plating	Board-Mounting Header	
				Panel type	Free Hanging type	L Bracket		Horizontal type	Vertical type
6	-	XX	1-178129-6	1-179555-3	1-179554-3	S	Gold	1-178139-2	1-178140-2
							Gold	1-178139-3	1-178140-3
							Tin	1-178139-5	1-178140-5
	-	YY	2-178129-6	2-179555-3	2-179554-3	S	Gold	2-178139-2	2-178140-2
							Gold	2-178139-3	2-178140-3
							Tin	2-178139-5	2-178140-5
-	XY	3-178129-6	3-179555-3	3-179554-3	S	Gold	3-178139-2	3-178140-2	
						Gold	3-178139-3	3-178140-3	
						Tin	3-178139-5	3-178140-5	
-	-	YX	※(1)	—	—	—	Gold	4-178139-2	—
-	-	ZX	※(1)	—	—	—	Tin	6-178139-5	—
10	-	XX	1-917659-5	—	—	-	Gold	1-316080-2	1-917657-2
							Gold	1-316080-3	1-917657-3
							Tin	1-316080-5	1-917657-5
	-	YY	2-917659-5	—	—	-	Gold	2-316080-2	2-917657-2
							Gold	2-316080-3	2-917657-3
							Tin	2-316080-5	2-917657-5
-	XY	3-917659-5	—	—	-	Gold	3-316080-2	3-917657-2	
						Gold	3-316080-3	3-917657-3	
						Tin	3-316080-5	3-917657-5	
12	-	XX	1-917659-6	1-179555-6	1-179554-6	L	Gold	1-316081-2	1-917658-2
							Gold	1-316081-3	1-917658-3
							Tin	1-316081-5	1-917658-5
	-	YY	2-917659-6	2-179555-6	—	L	Gold	2-316081-2	2-917658-2
							Gold	2-316081-3	2-917658-3
							Tin	—	—
-	XY	3-917659-6	3-179555-6	3-179554-6	L	Gold	3-316081-2	3-917658-2	
						Gold	3-316081-3	3-917658-3	
						Tin	—	—	
20	-	XX	1-917659-8	1-179555-8	—	-	-	—	—

Relative Product Information

Applicable contact...P. 39
 Performance & Specifications...P. 36
 Accessories...P. 112

For(1)D-3200S Receptacle housing, please see P.47
 PN 1-178128-3 and 3-178128-3 are used.

NOTE: all products are RoHS compliant On selection.



D-3200M Double-row High-voltage Modular Types

Mated Dimension

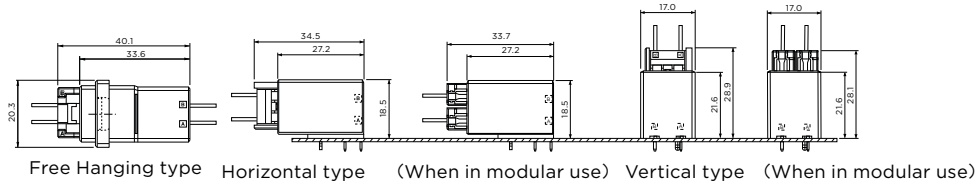

External Dimensions

■ Receptacle Housing

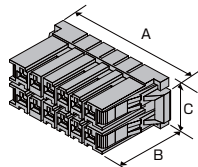

Pos	Key	Color	Part Number	Dimensions		
				A	B	C
6	XX	Black	1-178129-6	27.3	22.8	14.8
	YY	Black	2-178129-6			
	XY	Black	3-178129-6			
10	XX	Black	1-917659-5	37.5	22.8	14.8
	YY	Black	2-917659-5			
	XY	Black	3-917659-5			
12	XX	Black	1-917659-6	42.5	22.8	14.8
	YY	Black	2-917659-6			
	XY	Black	3-917659-6			
20	XX	Black	1-917659-8	62.9	22.8	14.8

■ Tab Housing

Panel type

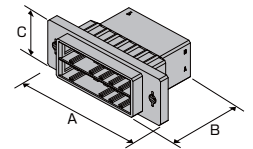

Pos	Key	Color	Part Number	Dimensions		
				A	B	C
6	XX	Black	1-179555-3	41.9	33.6	20.3
	YY	Black	2-179555-3			
	XY	Black	3-179555-3			
12	XX	Black	1-179555-6	57.9	33.6	20.3
	YY	Black	2-179555-6			
	XY	Black	3-179555-6			
20	XX	Black	1-179555-8	78.2	33.6	20.3

Free Hanging type

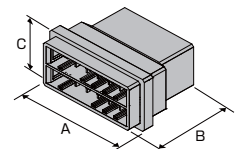

Pos	Key	Color	Part Number	Dimensions		
				A	B	C
6	XX	Black	1-179554-3	28.1	33.6	20.3
	YY	Black	2-179554-3			
	XY	Black	3-179554-3			
12	XX	Black	1-179554-6	43.4	33.6	20.3
	XY	Black	3-179554-6			

NOTE: all products are RoHS compliant On selection.

D-3200M Double-row High-voltage Modular Types

Board-Mounting Header

Horizontal type

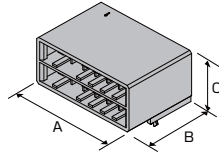

Pos	Key	Plating	Color	Part Number	Dimensions		
					A	B	C
6	XX	Gold	Black	1-178139-2	24.2	27.2	18.5
		Gold	Black	1-178139-3			
		Tin	Black	1-178139-5			
	YY	Gold	Black	2-178139-2			
		Gold	Black	2-178139-3			
		Tin	Black	2-178139-5			
	XY	Gold	Black	3-178139-2			
		Gold	Black	3-178139-3			
		Tin	Black	3-178139-5			
	YX	Gold	Black	4-178139-2			
ZX	Tin	Black	6-178139-5				
10	XX	Gold	Black	1-316080-2	34.3	27.2	18.5
		Gold	Black	1-316080-3			
		Tin	Black	1-316080-5			
	YY	Gold	Black	2-316080-2			
		Gold	Black	2-316080-3			
		Tin	Black	2-316080-5			
	XY	Gold	Black	3-316080-2			
		Gold	Black	3-316080-3			
		Tin	Black	3-316080-5			
	12	XX	Gold	Black			
Gold			Black	1-316081-3			
Tin			Black	1-316081-5			
YY		Gold	Black	2-316081-2			
		Gold	Black	2-316081-3			
		Tin	Black	—			
XY		Gold	Black	3-316081-2			
		Gold	Black	3-316081-3			
		Gold	Black	3-316081-3			

Board-Mounting Header

Vertical type

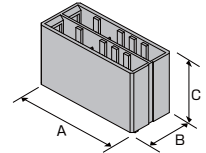

Pos	Key	Plating	Color	Part Number	Dimensions		
					A	B	C
6	XX	Gold	Black	1-178140-2	24.2	17.0	21.6
		Gold	Black	1-178140-3			
		Tin	Black	1-178140-5			
	YY	Gold	Black	2-178140-2			
		Gold	Black	2-178140-3			
		Tin	Black	2-178140-5			
	XY	Gold	Black	3-178140-2			
		Gold	Black	3-178140-3			
		Tin	Black	3-178140-5			
	10	XX	Gold	Black			
Gold			Black	1-917657-3			
Tin			Black	1-917657-5			
YY		Gold	Black	2-917657-2			
		Gold	Black	2-917657-3			
		Tin	Black	2-917657-5			
XY		Gold	Black	3-917657-2			
		Gold	Black	3-917657-3			
		Tin	Black	3-917657-5			
12		XX	Gold	Black	1-917658-2	39.4	17.0
	Gold		Black	1-917658-3			
	Tin		Black	1-917658-5			
	YY	Gold	Black	2-917658-2			
		Gold	Black	2-917658-3			
		Tin	Black	—			
	XY	Gold	Black	3-917658-2			
		Gold	Black	3-917658-3			
		Tin	Black	—			

NOTE: all products are RoHS compliant On selection.

D-3200M Double-row High-voltage Modular Types

Type Chart

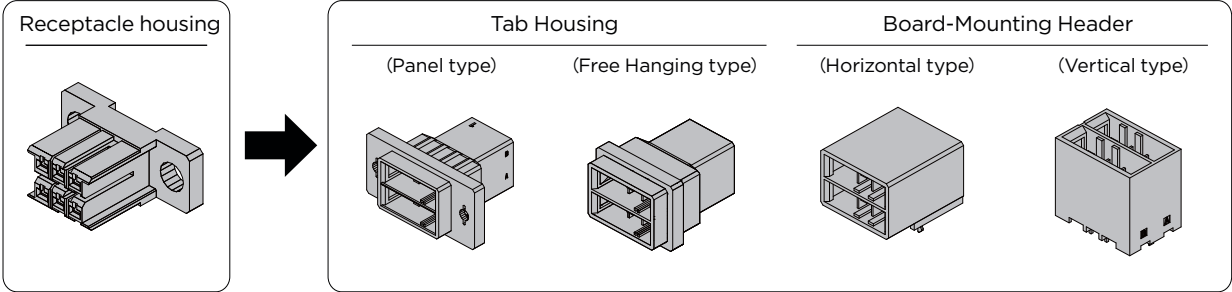

Pos	Color	Key	Receptacle housing	Tab housing		Plating	Board-Mounting Header	
				Panel type	Free Hanging type		Horizontal type	Vertical type
6	Black	XX	1-917266-3	1-179555-3	1-179554-3	Gold	1-178139-2	1-178140-2
						Gold	1-178139-3	1-178140-3
						Tin	1-178139-5	1-178140-5

Relative Product Information

- Applicable contact...P.39
- Performance & Specifications ...P.36
- Accessories ...P.112

Applications

Example of Compact Disk Device Application

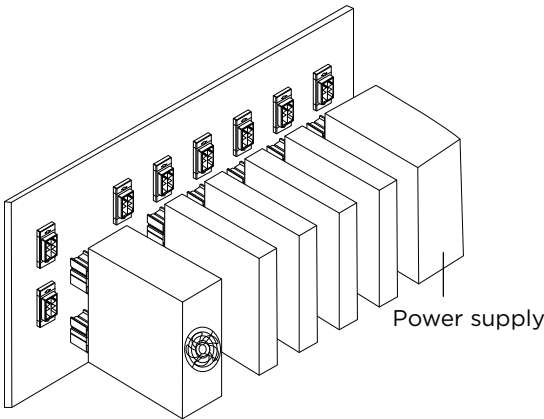

NOTE: all products are RoHS compliant On selection.



D-3200M Double-row High voltage Drawer Types

Mated Dimension

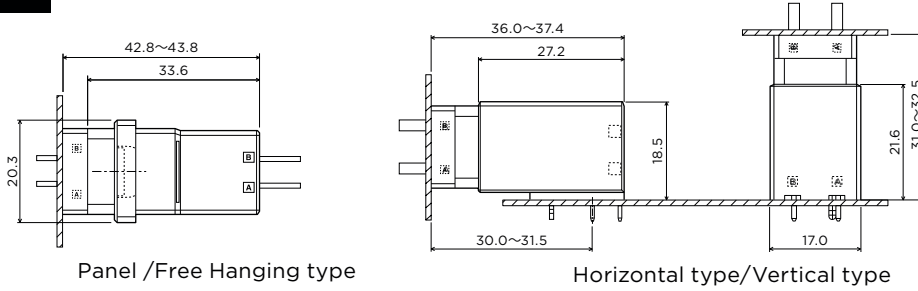

External Dimensions

Receptacle Housing (Drawer type)

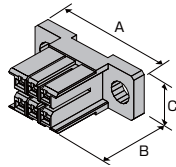

Pos	Key	Color	Part Number	Dimensions		
				A	B	C
6	XX	Black	1-917266-3	40.0	25.7	15.4

Tab Housing

Panel type

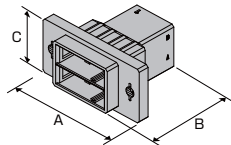

Pos	Key	Color	Part Number	Dimensions		
				A	B	C
6	XX	Black	1-179555-3	41.9	33.6	20.3

Free Hanging type

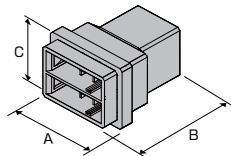

Pos	Key	Color	Part Number	Dimensions		
				A	B	C
6	XX	Black	1-179554-3	28.1	33.6	20.3

NOTE: all products are RoHS compliant On selection.

Board-Mounting Header

Horizontal type

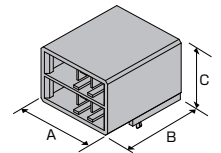

Pos	Key	Plating	Color	Part Number	Dimensions		
					A	B	C
6	XX	Gold	Black	1-178139-2	24.2	27.2	18.5
		Gold	Black	1-178139-3			
		Tin	Black	1-178139-5			

Vertical type

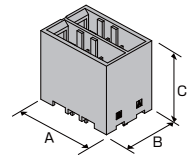

Pos	Key	Plating	Color	Part Number	Dimensions		
					A	B	C
6	XX	Gold	Black	1-178140-2	24.2	17.0	21.6
		Gold	Black	1-178140-3			
		Tin	Black	1-178140-5			

D-3200 FMLB (Sequential Type)

Type Chart

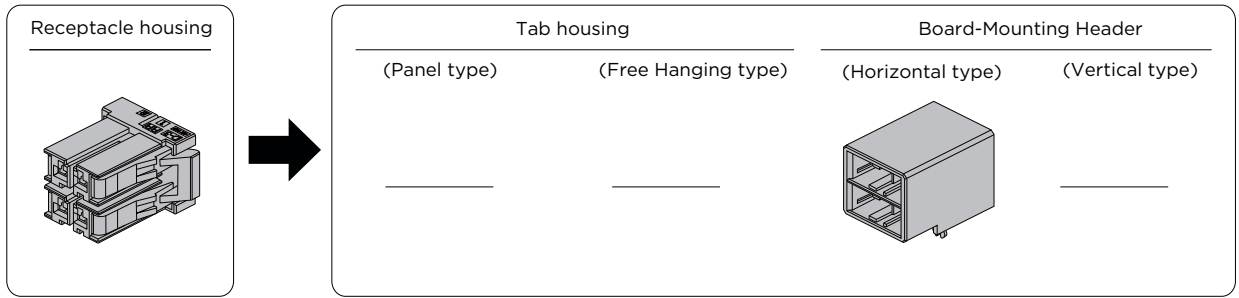

Pos	Color	Key	Receptacle housing	Tab housing		Plating	Board-Mounting Header	
				Panel type	Free Hanging type		Horizontal type	Vertical type
4	Black	RR	1-2291727-1	—	—	Gold	1-2299004-1	—
		SS	2-2291727-1	—	—		2-2299004-1	—
12	Black	RR	1-2291728-1	—	—	Gold	1-2299005-1	—
		SS	2-2291728-1	—	—		2-2299005-1	—
		RS	—	—	—		3-2299005-1	—

Mated Dimension

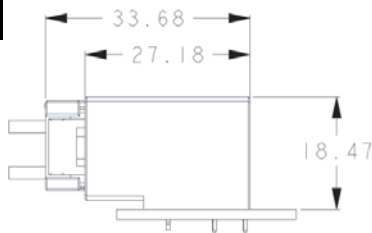

External Dimensions

Receptacle Housing

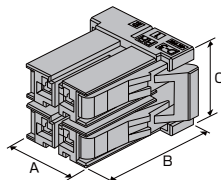

Pos	Key	Color	Part Number	Dimensions		
				A	B	C
4	RR	Black	1-2291727-1	14.2	22.8	14.8
	SS		2-2291727-1			
12	RR	Black	1-2291728-1	34.5	22.8	14.8
	SS		2-2291728-1			

Board-Mounting Header

Horizontal type

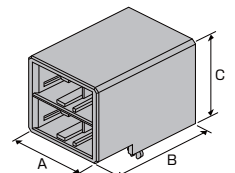

Pos	Key	Plating	Color	Part Number	Dimensions		
					A	B	C
4	RR	—	Black	1-2299004-1	14.2	22.8	14.8
	SS	—		2-2299004-1			
12	RR	—	Black	1-2299005-1	34.5	22.8	14.8
	SS	—		2-2299005-1			
	RS	—		3-2299005-1			

Relative Product Information

Applicable contact...P.39

Performance & Specifications ...P.36

Accessories ...P.112

NOTE: all products are RoHS compliant On selection.

Stress relief (optional)

Pos	Key	Plating	Part Number
4	RR	Black	1-2303376-1
	SS		2-2303376-1
12	RR	Black	1-2303378-1
	SS		2-2303378-1
	RS		3-2303378-1

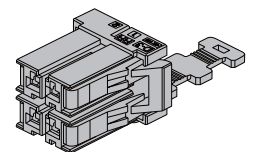

D-3200T Triple-row High Voltage Modular Types

Type Chart

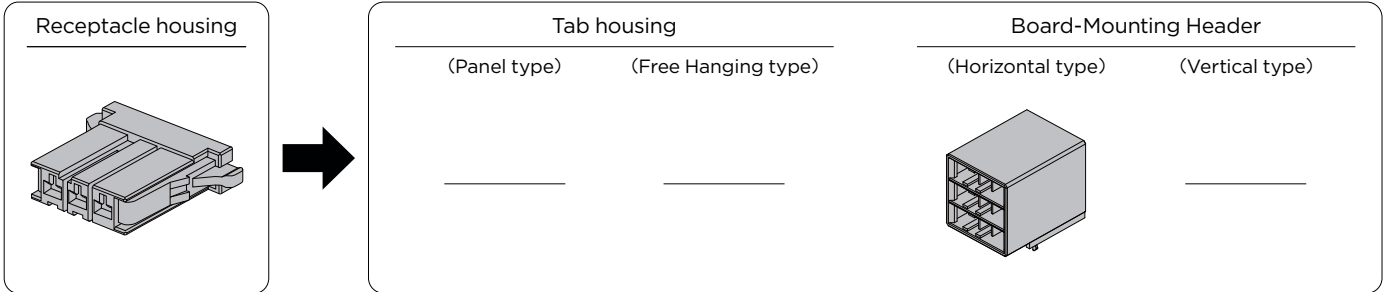

Receptacle Housing (maximum 9 Pos.)					
Single-Row (D-3200S) ※1			Double-Row (D-3200M)+Single-Row (D-3100S)		
POS	KEY	Part Number	POS	KEY	Part Number
3	X	1-178128-3	6	XX	1-178129-6
3	X	1-178128-3			
3	X	1-178128-3	3	X	1-178129-3
3	X	1-178128-3	3	Y	2-178129-3
3	X	1-178128-3	6	XX	1-178129-6
3	Y	2-178128-3			
3	Y	2-178128-3	3	X	1-178129-3
3	Y	2-178128-3	6	YY	2-178129-6
3	X	1-178128-3			
3	X	1-178128-3	3	X	1-178129-3
3	Y	2-178128-3	6	XY	3-178129-6
3	X	1-178128-3			
3	Z	3-178128-3	3	Z	3-178129-3
3	Y	2-178128-3	6	XY	3-178129-6
3	X	1-178128-3			

Board-Mounting Header			
Horizontal type (D-3200T)			
POS	KEY	Plating	Part Number
9	XXX	Au	1-1123624-2
		Sn	1-1123624-5
9	XXY	Au	3-1123624-2
		Sn	3-1123624-5
9	YYX	Au	4-1123624-2
		Sn	4-1123624-5
9	YYX	Au	5-1123624-2
		Sn	5-1123624-5
9	XYZ	Au	9-1123624-2

※1 refer to P.47

Relative Product Information

Applicable contact...P.39
Performance & Specifications ...P.36

Mated Dimension

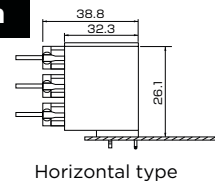

External Dimensions

Receptacle Housing

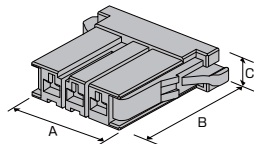

Pos	Key	Color	Part Number	Dimensions		
				A	B	C
3	X	Black	1-178128-3	29.7	22.8	7.2
	Y	Black	2-178128-3			
	Z	Black	3-178128-3			
6	XX	Black	1-178129-6	27.3	22.8	14.8
	YY	Black	2-178129-6			
	XY	Black	3-178129-6			

Board-Mounting Header

Horizontal type

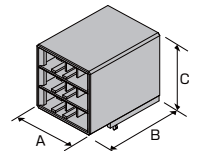

Pos	Key	Plating	Color	Part Number	Dimensions		
					A	B	C
9	XXX	Gold	Black	1-1123624-2	24.2	32.3	27.1
		Tin	Black	1-1123624-5			
	XXY	Tin	Black	3-1123624-5			
	YYX	Tin	Black	4-1123624-5			
	YYX	Gold	Black	5-1123624-2			
	XYZ	Gold	Black	9-1123624-2			

NOTE: all products are RoHS compliant On selection.



D-3400F Skyscraper Connectors

Type Chart

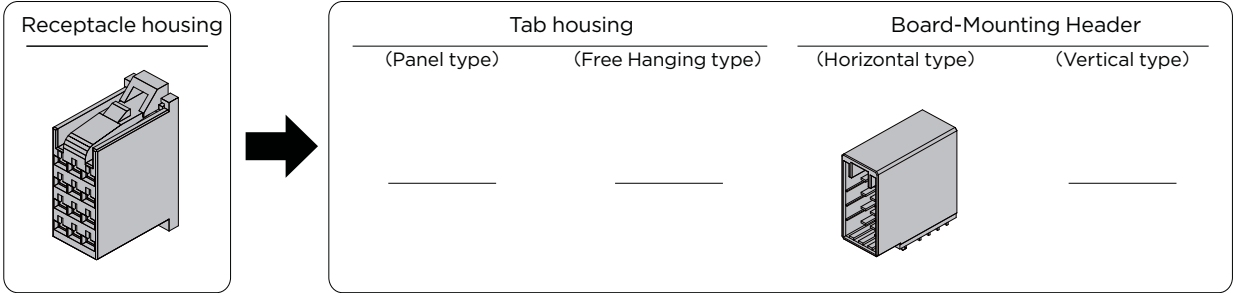

Pos	Color	Key	Receptacle housing	Tab housing		Plating	Board-Mounting Header	
				Panel type	Free Hanging type		Horizontal type	Vertical type
12	Black	—	178214-1	—	—	Gold	178216-2	—
				—	—	Gold	178216-3	—
				—	—	Tin	178216-5	—
20	Black	—	917249-1	—	—	Gold	917251-2	—
				—	—	Gold	917251-3	—
				—	—	Tin	917251-5	—

Mated Dimension

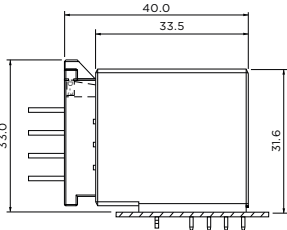

Horizontal type

External Dimensions

■ Receptacle Housing

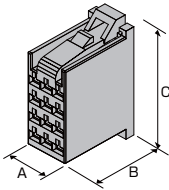

Pos	Key	Color	Part Number	Dimensions		
				A	B	C
12	—	Black	178214-1	12.2	22.8	32.1
20	—	Black	917249-1	19.8	22.8	32.1

■ Board-Mounting Header

Horizontal type

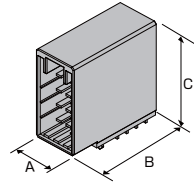

Pos	Key	Plating	Color	Part Number	Dimensions		
					A	B	C
12	—	Gold	Black	178216-2	15.0	33.5	31.6
	—	Gold	Black	178216-3			
	—	Tin	Black	178216-5			
20	—	Gold	Black	917251-2	22.6	33.5	31.6
	—	Gold	Black	917251-3			
	—	Tin	Black	917251-5			

NOTE: all products are RoHS compliant On selection.



D-3500D Sensor Connector

Type Chart

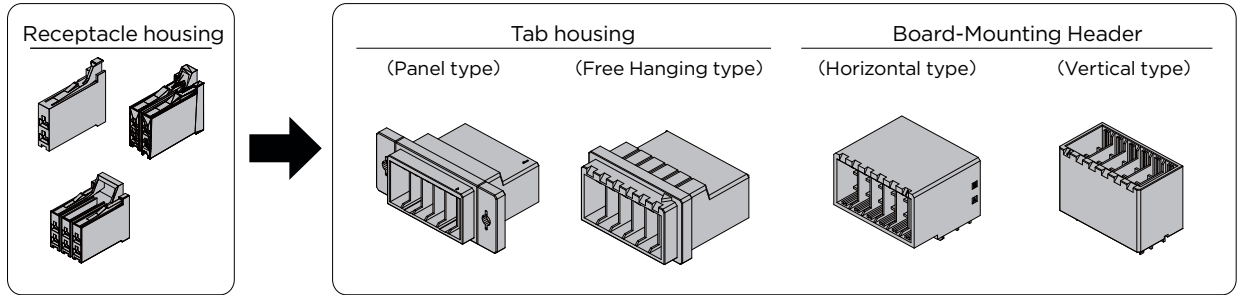

Pos	Color	Key	Receptacle housing	Tab housing			Plating	Board-Mounting Header	
				Panel type	Free Hanging type	L Bracket		Horizontal type	Vertical type
2	Black	—	175362-1	—	—	—	—	—	—
			175362-2	—	—	—	—	—	—
			175362-3	—	—	—	—	—	—
4	Black	—	175363-1	—	—	—	Gold	1376133-2	—
	White		1-175363-1						
	Black		175363-2*						
	Black		2-175363-1						
6	Black	—	1318095-1	—	—	—	—	—	—
			1318095-2						
12	Black	—	—	917241-6 3-917241-6	917242-6 3-917242-6	S	Gold	177555-2	316516-2
							Gold	177555-3	316516-3
							Gold	1-177555-2	—
							Tin	177555-5	316516-5
20	Black	—	—	917241-8 3-917241-8	917242-8 3-917242-8	S	Gold	175365-2	316517-2
							Gold	175365-3	316517-3
							Tin	175365-5	316517-5

* Small Lever Type

Mated Dimension

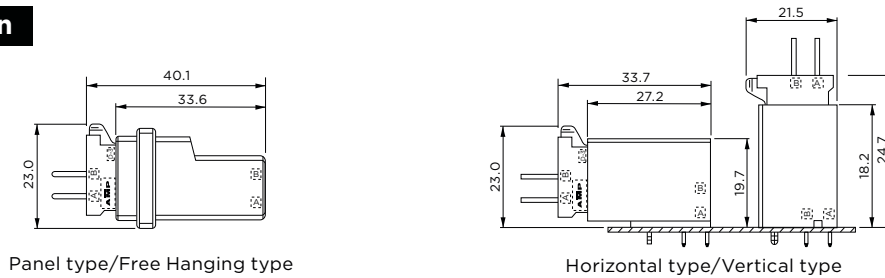

Relative Product Information

- Applicable contact...P.39
- Performance & Specifications ...P.36
- Accessories ...P.112

NOTE: all products are RoHS compliant On selection.

D-3500D Sensor Connector

External Dimensions

■ Receptacle Housing

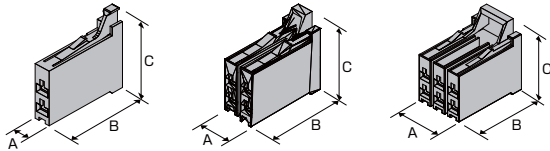

Pos	Key	Color	Part Number	Dimensions		
				A	B	C
2	—	Black	175362-1	4.6	22.8	21.0
	—	Black	175362-2			
	—	Black	175362-3			
4	—	Black	175363-1	9.7	22.8	21.0
	—	White	1-175363-1			
	—	Blue	2-175363-1			
	—	Black	175363-2			
6	—	Black	1318095-1	14.7	22.8	21.0
	—	Black	1318095-2			

■ Tab Housing

Panel type

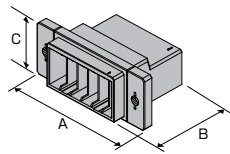

Pos	Key	Color	Part Number	Dimensions		
				A	B	C
12	—	Black	917241-6	52.0	33.6	21.5
	—	Black	3-917241-6			
20	—	Black	917241-8	72.0	33.6	21.5
	—	Black	3-917241-8			

Free Hanging type

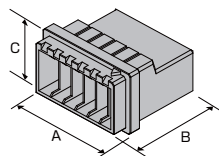

Pos	Key	Color	Part Number	Dimensions		
				A	B	C
12	—	Black	917242-6	36.4	33.6	21.5
	—	Black	3-917242-6			
20	—	Black	917242-8	56.8	33.6	21.5
	—	Black	3-917242-8			

NOTE: all products are RoHS compliant On selection.

■ Board-Mounting Header

Horizontal type

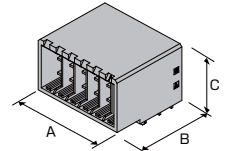

Pos	Key	Plating	Color	Part Number	Dimensions		
					A	B	C
4	—	Gold	Black	1376133-2	12.2	27.2	19.7
12	—	Gold	Black	177555-2	32.5	27.2	19.7
	—	Gold	Black	177555-3			
	—	Tin	Black	177555-5			
20	—	Gold	Black	1-177555-2	52.8	27.2	19.7
	—	Gold	Black	175365-2			
	—	Gold	Black	175365-3			
	—	Tin	Black	175365-5			

Vertical type

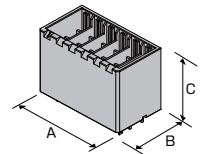

Pos	Key	Plating	Color	Part Number	Dimensions		
					A	B	C
12	—	Gold	Black	316516-2	32.5	18.2	21.6
	—	Gold	Black	316516-3			
	—	Tin	Black	316516-5			
20	—	Gold	Black	316517-2	52.8	18.2	21.6
	—	Gold	Black	316517-3			
	—	Tin	Black	316517-5			

Spring Clamp Type

The Spring Clamp Type series is a spring clamp type connector applicable to Servo I/O application, etc.

Thanks to the on-site mounting without any crimping tools, working time can be saved significantly.



- Adopt the standard wiring method as Dynamic series, and Spring clamp type contacts on receptacle side which comply with UL1059.

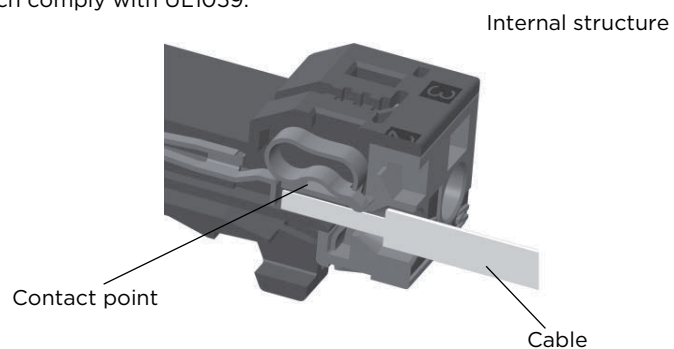

- Applicable to ports of power supply series where a UL508 servo amplifier and inverter, etc. must be used.
- The implementation can be carried out on-site without any crimping tools. Compared to the spiral wiring method, working time is saved significantly.

Product Features

1. Spring clamp contact

The contact is assembled in housing already with a spring clamp design which provide easy on-site installation, therefore increase the efficiency of assembly.

2. Audible Latching

Obvious lock sound and feeling when mating means work can be done without mistakes, such as mismatching (halfmating), even if the connection cannot be seen.

3. Keying

The housing is keyed (with a slit), so differentiating between X keys and Y keys prevents mismatching. It is also possible to make more key patterns by using keying plugs.

Spring Clamp Series Performance and Specifications

Performance

Item \ Series	D-2950	D-3950	D-4950
Contact pitch [mm]	5.08	7.5	7.5
Rated current max. UL [A]	10 (AWG14 x 1)	14.5 (AWG14 x 1)	22 (AWG10 x 1)
Rated voltage UL1059 B [V]	300 AC/DC	300 AC/DC	300 AC/DC
Rated voltage UL1059 C [V]	-	300 AC/DC	300 AC/DC
Rated voltage UL1059 D [V]	300 AC/DC	600 AC/DC	600 AC/DC
Dielectric withstanding Voltage	2,200V AC	2,200V AC	2,200V AC
Wire size [AWG]	18-14	22-14	10-16
Wire size [sq]	0.75-2.0	0.3-2.0	1.25-5.5

Positions/ Wire size / Rated current

D-2950 series

No of energized positions	Current(A)				
	AWG14	AWG16	AWG18	AWG20	AWG22
5	11.25	10.5	9.5	8	6.5
6	10.5	9.75	9	7	5.5

D-3950 series

No of energized positions	Current(A)				
	AWG14	AWG16	AWG18	AWG20	AWG22
1	14.5	13.75	13	10.75	8.7
2-5	12.75	11.75	10.25	8.25	7.2
6-11	11.8	9.75	8.75	7	5.5

D-4950 series

No of energized positions	Current(A)				
	AWG10	AWG12	AWG14	AWG16	
1	22	19	15	10	
2-5					
6-11					

Product Specifications

Item \ Series	D-2950	D-3950	D-4950
Product Specification	108-140221	108-78997	108-140216
Application Specification	408-78172	411-78272	408-78173

Materials and Plating

Description	Material	Finish
Receptacle contact (mating area only)	Copper alloy	Mating area: 0.38µm Gold plating over 1.27µm Nickel under plating
Board-mounting header contact	Copper alloy	Mating area: 0.38µm Gold plating over 1.27µm Nickel under plating Tail area: 2µm TIN plating over 1.27µm Nickel under plating
Receptacle Housing Board-mounting header Housing		Thermoplastic PBT contain glass fiber, UL94V-0,

D-2950 Spring Clamp Type

Type Chart

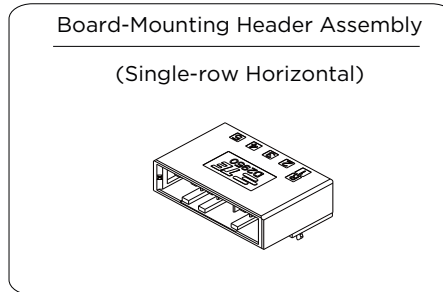
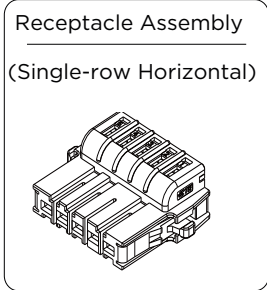

Pos	Color	Key	Plating	Circuit mark	Receptacle Assembly	Board-Mounting Header Assembly
					Single-row Horizontal	Single-row Horizontal
5	Black	X	Gold	Yes	1-2347004-5	1-2347005-5
6	Black	X	Gold	Yes	1-2347004-6	1-2347005-6

Mated Dimension

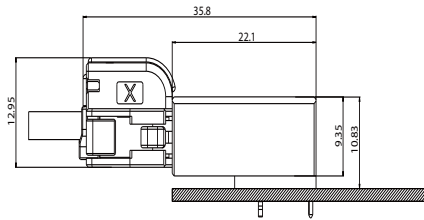

Opener: 2347681-1

External Dimensions

■ Receptacle Assembly Single-Row Horizontal

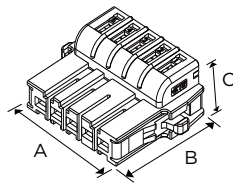

Pos	Key	Plating	Color	Part Number	Dimensions		
					A	B	C
5	X	Gold	Black	1-2347004-5	39.2	29.0	13.0
6	X	Gold	Black	1-2347004-6	44.3	29.0	13.0

■ Board-Mounting Header Assembly Single-Row Horizontal

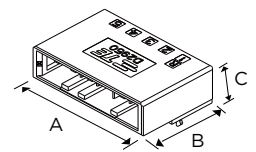

Pos	Key	Plating	Color	Part Number	Dimensions		
					A	B	C
5	X	Gold	Black	1-2347005-5	34.3	22.1	10.9
6	X	Gold	Black	1-2347005-6	39.4	22.1	10.9

NOTE: all products are RoHS compliant On selection.

D-3950 Spring Clamp Type

Type Chart

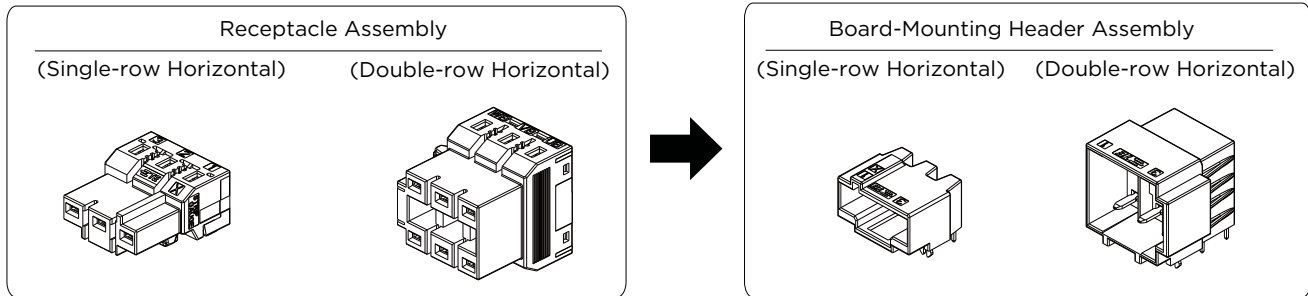

Pos	Color	Key	Plating	Circuit mark	Receptacle Assembly		Board-Mounting Header Assembly	
					Single-row Horizontal	Double-row Horizontal	Single-row Horizontal	Double-row Horizontal
3	Black	X	Gold	Yes	3-2229794-1	—	3-2229803-1	—
				No	3-2289080-1	—		—
4	Black	X	Gold	Yes	1-2331743-4	—	1-2271457-4	—
				No	1-2331743-1	—		—
				Y	2-2331743-1	—		2-2271457-4
6	Black	X	Gold	No	1-2271454-6	—	1-2271457-6	—
6	Black	—	Gold	Yes	—	2229800-1	—	2229806-1
※7	Black	Y	Gold	Yes	1-2229794-2	—	1-2229803-2	—
8	Black	X	Gold	Yes	1-2349815-2	—	1-2271457-8	—
11	Black	X	Gold	Yes	1-2229794-1	—	1-2229803-1	—
				No	1-2289080-1	—		—

※ The 7P connector is a 11P connector with 4 contacts removed.

Mated Dimension

Double row

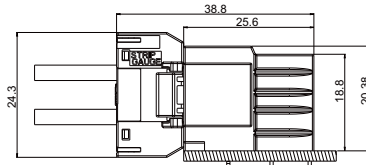

Single row

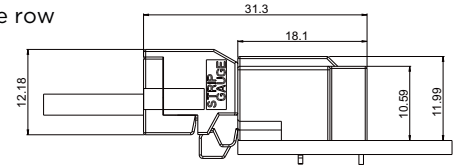

Opener: 1981045-1

External Dimensions

■ Receptacle assembly

Single-Row Horizontal

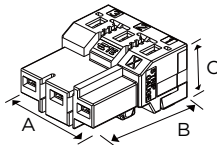

Pos	Key	Plating	Circuit Illustration	Color	Part Number	Dimensions			
						A	B	C	
3	X	Gold	Yes	Black	3-2229794-1	22.0	25.4	15.6	
					3-2289080-1	22.0	25.4	15.6	
4	X	Gold	Yes	Black	1-2331743-4	27.7	25.4	15.6	
					No	1-2331743-1	27.7	25.4	15.6
					Y	2-2331743-1	27.7	25.4	15.6
6	X	Gold	No	Black	1-2271454-6	44.5	25.4	15.6	
※7	Y	Gold	Yes	Black	1-2229794-2	82.0	25.4	15.6	
8	X	Gold	Yes	Black	1-2349815-2	57.7	25.4	15.6	
11	X	Gold	Yes	Black	1-2229794-1	82.0	25.4	15.6	
					No	1-2289080-1	82.0	25.4	15.6

※ The 7P connector is a 11P connector with 4 contacts removed.

Double-row Horizontal

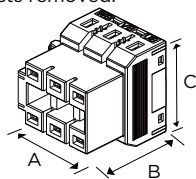

Pos	Key	Plating	Color	Part Number	Dimensions		
					A	B	C
6	—	Gold	Black	2229800-1	25.2	25.6	20.4

NOTE: all products are RoHS compliant On selection.

■ Board-Mounting Header Assembly

Single-Row Horizontal

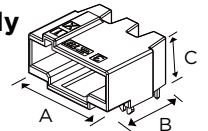

Pos	Key	Plating	Color	Part Number	Dimensions		
					A	B	C
3	X	Gold	Black	3-2229803-1	22.0	18.1	12.0
4	X	Gold	Black	1-2271457-4	29.5	18.1	12.0
				2-2271457-4	29.5	18.1	12.0
6	X	Gold	Black	1-2271457-6	44.5	18.1	12.0
※7	Y	Gold	Black	1-2229803-2	82.0	18.1	12.0
8	X	Gold	Black	1-2271457-8	59.5	18.1	12.0
11	X	Gold	Black	1-2229803-1	82.0	18.1	12.0

※ The 7P connector is a 11P connector with 4 contacts removed.

Double-row Horizontal

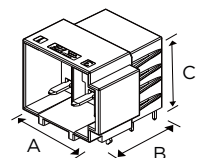

Pos	Key	Plating	Color	Part Number	Dimensions		
					A	B	C
3	X	Gold	Black	2229806-1	22.0	18.1	12.0

D-4950 Spring Clamp Type

Type Chart

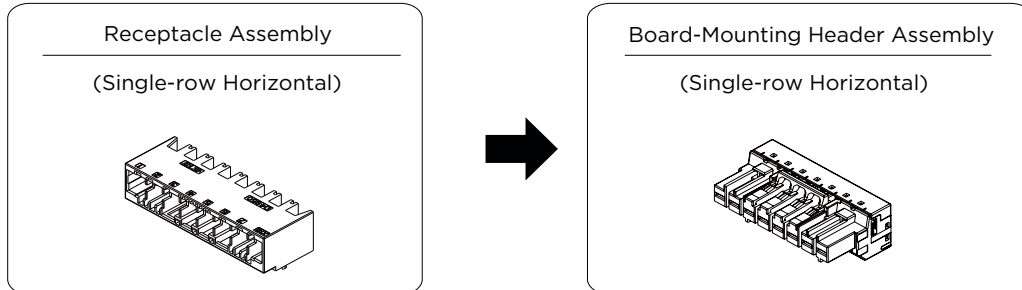

Pos	Color	Key	Plating	Circuit mark	Receptacle Assembly	Board-Mounting Header Assembly
					Single-row Horizontal	Single-row Horizontal
8	Black	X	Gold	Yes	1-2349849-8	1-2349825-8

Mated Dimension

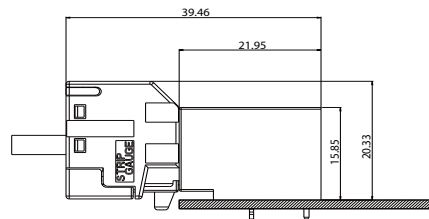

Opener: 2349891-1

External Dimensions

■ Receptacle Assembly

Single-Row Horizontal

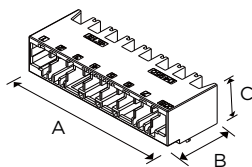

Pos	Key	Plating	Color	Part Number	Dimensions		
					A	B	C
8	X	Gold	Black	1-2349849-8	61.5	31.7	22.1

■ Board-Mounting Header Assembly

Single-Row Horizontal

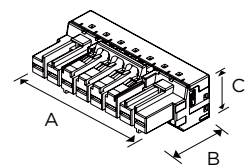

Pos	Key	Plating	Color	Part Number	Dimensions		
					A	B	C
8	X	Gold	Black	1-2349825-2	61.5	22.0	15.9

On-site Push-in Type

The On-site push-in type series is applicable to the power input and output of servo control systems.

The compact size saves space on the board and facilitates the high-density design of the board. The vertically plugging design and the newly added cable unplugging button make the “tool-free” on-site mounting possible.

The high temperature housing material applicable to reflow soldering and the economical version enrich the choice of connectors for the servo application.

The On-site push-in type series inherits the Dynamic's high reliability, audible & tactile locking system and key design to provide a more efficient solution for the installation process.



- Adopt the standard wiring method as Dynamic series, and Spring clamp type contacts on receptacle side which comply with UL1059.

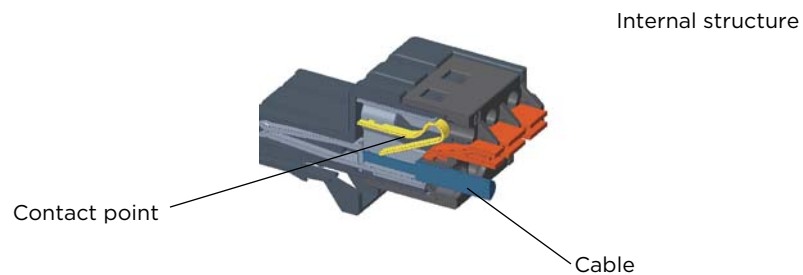

- Applicable to ports of power supply series where a UL508 servo amplifier and inverter, etc. must be used.
- The implementation can be carried out on-site without any crimping tools. Compared to the spiral wiring method, working time is saved significantly.

Product Features

1. Release button design

On-site Push-in type has a release button design, which could support wire inserting and removing of the connector, therefore achieving toolless assembly.

2.Spring clamp contact

The contact is assembled in housing already with a spring clamp design which provide easy on-site installation, therefore increase the efficiency of assembly.

3.High temperature housing material

Housing is made of high temperature material, therefore withstand reflow soldering process.

4. Three different Header options

Three different Headers-including horizontal header, vertical header and reversed header-which fit to varies of application needs.

5. Two plating types

Both gold plating and tin plating contacts balance the high reliability and economical requests.

6.Center locking

This is the first application of a center lock in Dymic series. On-board space requirements can be mounted in a tight space for high-density mounting on boards requiring signal lines.

7.Audible Latching

Obvious lock sound and feeling when mating means work can be done without mistakes, such as mismating (halfmating), even if the connection cannot be seen.

Spring Clamp Series Performance and Specifications

Performance

Item	Series	D-2970
Contact pitch [mm]		5.0
Rated current max. UL [A]		10 (AWG14 x 1)
Rated voltage UL1059 B [V]		20 (AWG14 x 1)
Rated voltage UL1059 C [V]		300 AC/DC
Rated voltage UL1059 D [V]		400 AC/DC
Dielectric withstanding Voltage		2,200V AC
Wire size [AWG]		18-14
Wire size [sq]		0.75-2.0

Product Specifications

Item	Series	D-2970
Product Specification		108-140223
Application Specification		408-78171

Positions/ Wire size / Rated current

D-2970 Series

No of energized positions	Current(A)						
	AWG 26 With ferrule	AWG 24	AWG 22	AWG 20	AWG 18	AWG 16	AWG 14
3	4.5	5.5	7	8	9.5	11.5	15
4	4	4.5	6	7.5	9	11.5	14
Reference UL1059 Limit	1	2	3	5	7	10	15

When spec is over UL1059 limit, UL1059 requirement equipment shall use Limit current.

Materials and Plating

Description	Material	Finisher
Receptacle contact	Copper alloy	Mating area: 0.38 μ m Gold or 1.0 μ m Tin plating over 1.27 μ m Nickel under-plated
Board-mounting header contact	Copper alloy	Mating area: 0.38 μ m Gold plating or 2.5 μ m Tin plating over 1.27 μ m Nickel under-plated Tail area: 2 μ m TIN plating over 1.27 μ m Nickel under-plated
Receptacle Housing Board-mounting header Housing		Liquid Crystal Plastic (LCP), UL94V-0,

D-2970 On-site Push-in Type

Type Chart

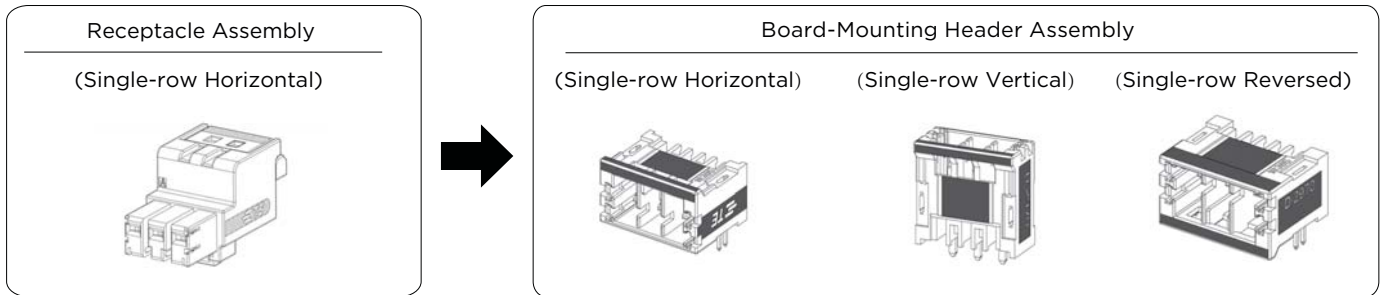

Pos	Color	Key	Plating	Board Mounting Header Assembly			
				Receptacle Assembly Single-Row Horizontal	Single-Row Horizontal	Single-row Vertical	Single-row Reversed
3	Black	X	Tin	2336488-3	2336490-3	2336494-3	2336491-3
3	Black	X	Gold	2-2336488-3	2-2336490-3	2-2336494-3	2-2336491-3
4	Black	X	Tin	2336488-4	2336490-4	2336494-4	2336491-4
4	Black	X	Gold	2-2336488-4	2-2336490-4	2-2336494-4	2-2336491-4

Mated Dimension

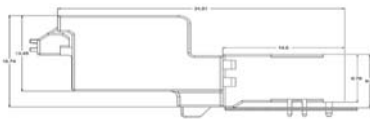

Single-Row Horizontal

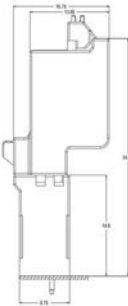

Single-row Vertical



Single-row Reversed

External Dimensions

Receptacle Assembly Single-Row Horizontal

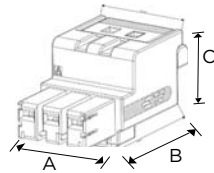

Pos	Key	Plating	Color	Part Number	Dimensions		
					A	B	C
3	X	Tin	Black	2336488-3	17	34	18.7
3	X	Gold	Black	2-2336488-3	17	34	18.7
4	X	Tin	Black	2336488-4	22	34	18.7
4	X	Gold	Black	2-2336488-4	22	34	18.7

Board-Mounting Header Assembly Single-Row Horizontal

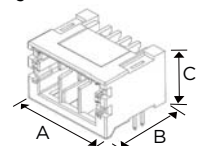

Pos	Key	Plating	Color	Part Number	Dimensions		
					A	B	C
3	X	Tin	Black	2336490-3	19.9	14.8	9.8
3	X	Gold	Black	2-2336490-3	19.9	14.8	9.8
4	X	Tin	Black	2336490-4	24.9	14.8	9.8
4	X	Gold	Black	2-2336490-4	24.9	14.8	9.8

Single-Row Vertical

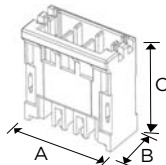

Single-Row Reversed

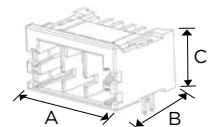

Pos	Key	Plating	Color	Part Number	Dimensions		
					A	B	C
3	X	Tin	Black	2336494-3	19.9	9.8	14.8
3	X	Gold	Black	2-2336494-3	19.9	9.8	14.8
4	X	Tin	Black	2336494-4	24.9	9.8	14.8
4	X	Gold	Black	2-2336494-4	24.9	9.8	14.8

Pos	Key	Plating	Color	Part Number	Dimensions		
					A	B	C
3	X	Tin	Black	2336491-3	19.9	14.8	9.8
3	X	Gold	Black	2-2336491-3	19.9	14.8	9.8
4	X	Tin	Black	2336491-4	24.9	14.8	9.8
4	X	Gold	Black	2-2336491-4	24.9	14.8	9.8

NOTE: all products are RoHS compliant On selection.

Tap Connector: Dyna-Tap Connectors

The common FA equipment is a device formed by combining functionally separated units in a final process. Tap on the circuit board was the original method used for supplying power to each unit.

Therefore, TE developed a tap connector with tap function—Dyna-Tap, which will not further burden the circuit board of which the space should be further saved in the future.

Dyna-Tap Connectors is a Dynamic series tap connector developed as an FA power connector, so it is the most suitable product for tap of the main power cable. (An application has been made for the design of its appearance)

Its specification is 6P to support the tap of the 3-phase power cable system widely used in the industry.

The relay type and panel type of the product has been developed. The matching model is 1-178288-6.

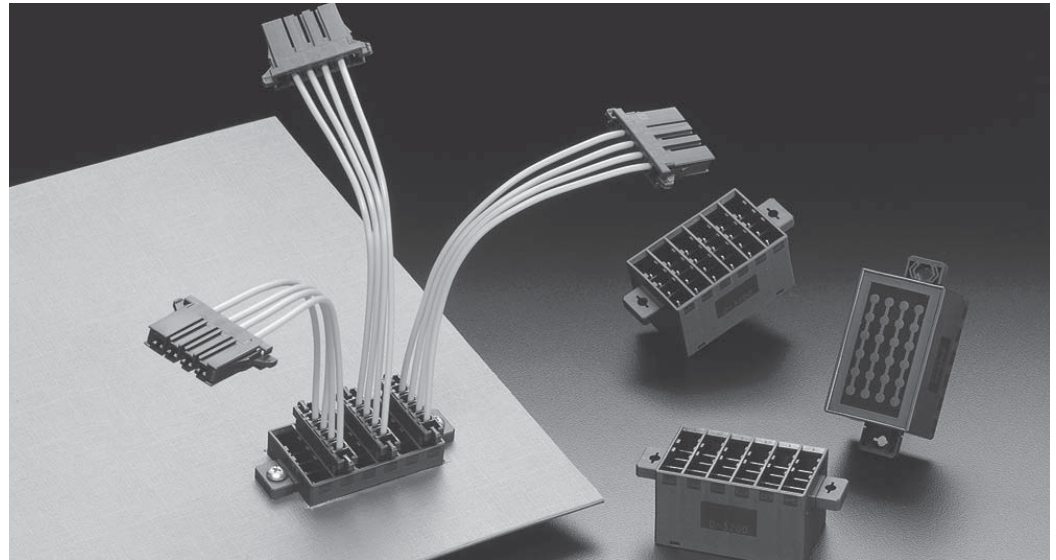

D-3100 Dyna-Tap18P(6Px3ROW)

Highlight

Since in most applications it is fixed outside the circuit board (chassis), a dust cover is installed to prevent dust from entering the inside of the housing. Therefore, it can be used in harsh environments.

Application

- Power tap in the elevator control room
- Power tap of power protection relays, etc.
- Power tap in the semiconductor production equipment unit room
- Power supply for production line equipment

Performance

- Rated voltage: 250V AC/DC
- Rated current: 8A (when the 18P and AWG#14 are used)
- No of Pos.: 6Px3 = 18P (6P tap)
- Durability 500 cycles
- Product standard: 108-5754

D-3200 Dyna-Tap24P(4Px6ROW)

Highlight 1

The Dynamic series connectors and contacts can be used. It is a power supply board that uses the Dynamic series (D-3200S 4P REC) with excellent connection reliability and gain high reputation. Compared to terminal blocks, its installation and maintenance costs are reduced significantly. Meanwhile, compatible terminals enable less costs of use and inventory.

Highlight 2

Positions of Power board installation can be set freely. Considering that the relay type and panel type connectors are used jointly, panel type with fixtures near to opener or bottom are both available.

Highlight 3

Cost advantage by reducing number of components used and saving working hours on installation.

Other highlights

- The Tin plated and Gold-plated type (0.38 mm) are provided.
- The back is engraved with an electrical connection diagram.

D-3100 Dyna-Tap 18P(6Px3ROW), 24P(6Px4ROW)

Type Chart

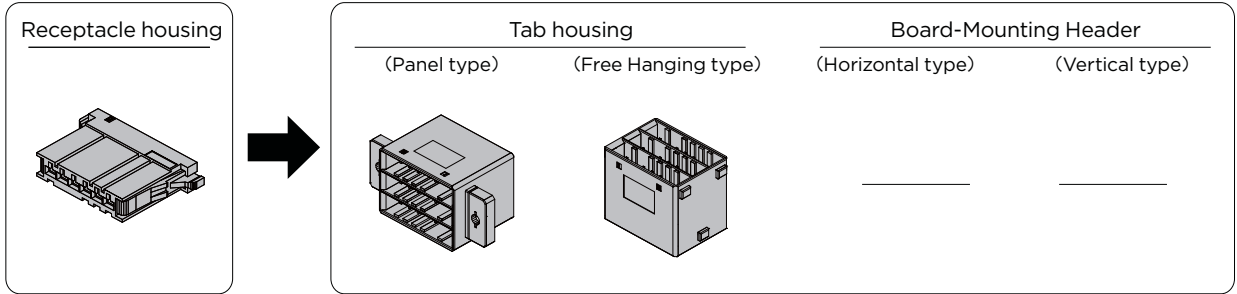

Pos	Color	Key	Receptacle housing	Tab housing		Through-hole	Plating		Board-Mounting Header	
				Panel type	Free Hanging type		Horizontal type	Vertical type		
6	Black	X	1-178288-6	—	—	—	—	—	—	—
18	Black	X	—	1376807-2	1376807-1	—	—	—	—	—
24	Black	X	—	—	—	1971003-1	—	—	—	—
	Black	X	—	—	—	1971003-2	—	—	—	—

Mated Dimension

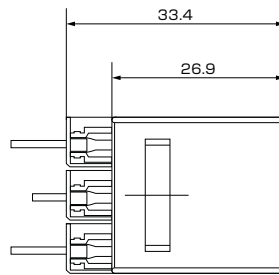

Panel type/Free Hanging type

External Dimensions

Receptacle Housing

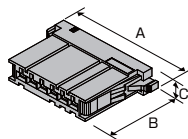

Pos	Key	Color	Part Number	Dimensions		
				A	B	C
6	X	Black	1-178288-6	38.2	22.8	7.2

Through-hole

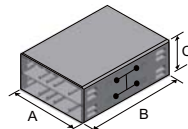

Pos	Key	Color	Part Number	Dimensions		
				A	B	C
24	X	Black	1971003-1	33.1	45.7	17.1
	X	Black	1971003-2	35.1	45.7	35.1

NOTE: all products are RoHS compliant On selection.

Board-Mounting Header

Panel type

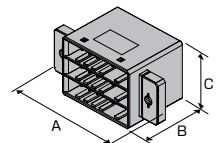
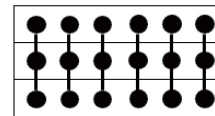

Pos	Key	Plating	Color	Part Number	Dimensions		
					A	B	C
18	X	Gold	Black	1376807-2	51.0	26.9	24.6

Free Hanging type

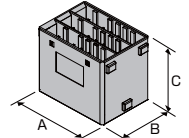

Pos	Key	Plating	Color	Part Number	Dimensions		
					A	B	C
18	X	Gold	Black	1376807-1	33.1	24.6	26.9

D-3200 Dyna-Tap 24P(4Px6ROW)

Type Chart

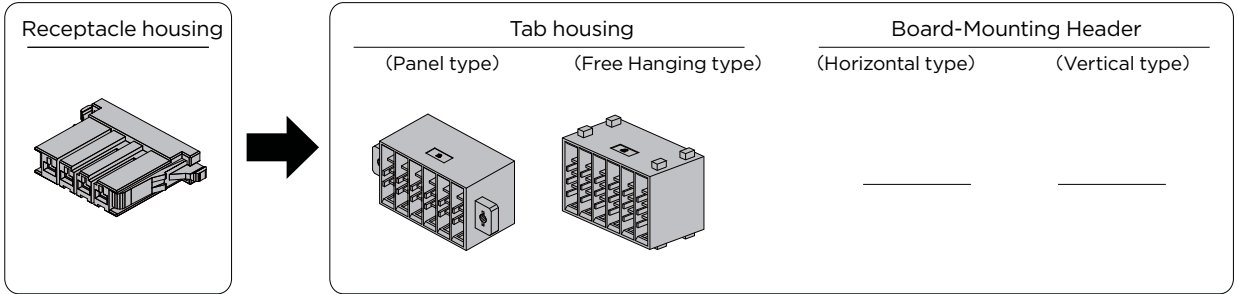

Pos	Color	Key	Receptacle housing	Tab housing		Plating	Board-Mounting Header	
				Panel type	Free Hanging type		Horizontal type	Vertical type
4	Black	X	1-178128-4	—	—	—	—	—
24	Black	X	—	1827691-2×1	1827691-1	Gold	—	—
	Black	X	—	1-1827691-2×1	1-1827691-1	Tin	—	—
	Black	X	—	1827691-3×2	—	Gold	—	—
	Black	X	—	1-1827691-3×2	—	Tin	—	—

Mated Dimension

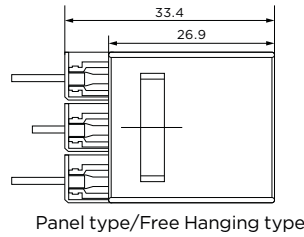

External Dimensions

Receptacle Housing

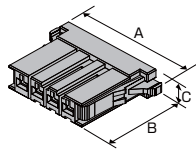

Pos	Key	Color	Part Number	Dimensions		
				A	B	C
4	X	Black	1-178128-4	24.6	22.8	7.2

Tab housing

Panel type

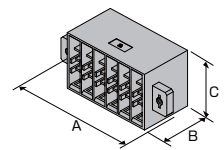
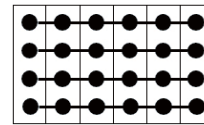

Pos	Key	Plating	Color	Part Number	Dimensions		
					A	B	C
24	X	Gold	Black	1827691-2	65.0	26.9	29.2
	X	Tin	Black	1-1827691-2			
	X	Gold	Black	1827691-3			
	X	Tin	Black	1-1827691-3			

Free Hanging type

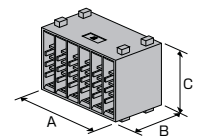

Pos	Key	Plating	Color	Part Number	Dimensions		
					A	B	C
24	X	Gold	Black	1827691-1	47.5	26.9	29.2
	X	Tin	Black	1-1827691-1			

NOTE: all products are RoHS compliant On selection.



D-4000 Series

Series introduction

It is a connector most appropriate for industrial equipment equipped with 20A power cords. The optimum size meets the compactness and high current requirements of the equipment.

The terminal is newly designed to have 4 contact points.

Compared with the Dynamic3000 series, it can ensure a current of above 50% while only increase 14% in mated height, so that miniaturization is achieved. Compared to existing products, each positions has a current capacity increased by about 32%.

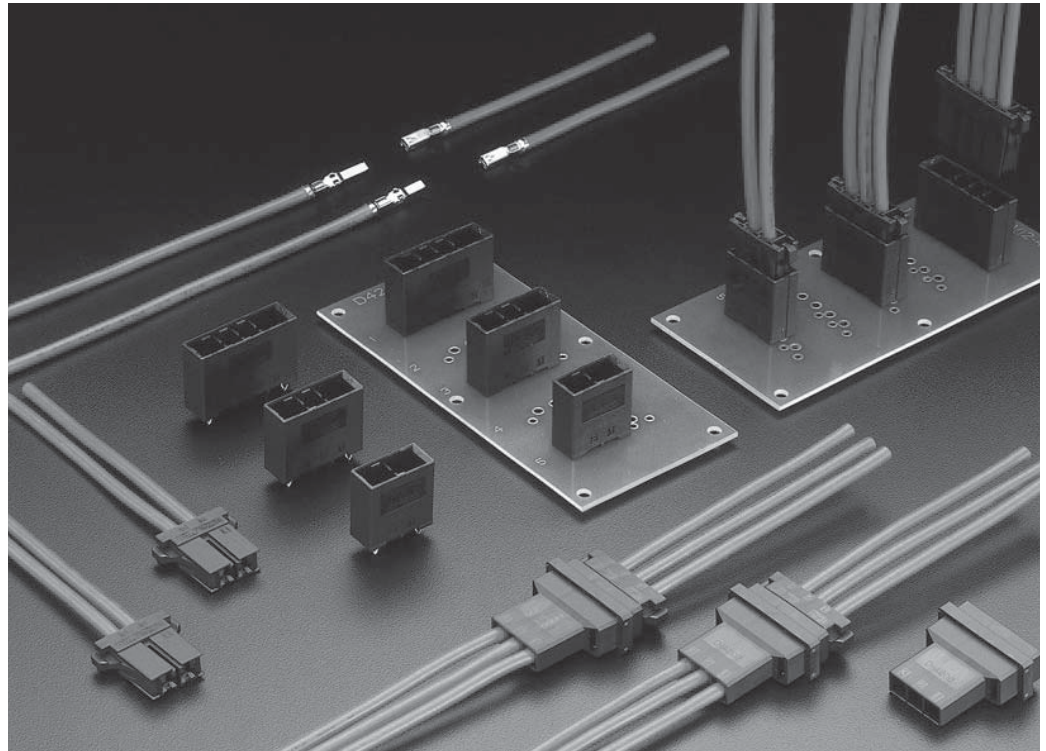

Product Features

1. Small Size/High Current Contact

The contacts are newly-designed with 4 points of contact. This allows significantly improved current capacity (rated 20A maximum) as well as reliability.

2. The sequential contacts

The sequential contact is a longer tab contact. When used in connection with the regular contacts it provides a ground that mates before the other power contacts.

3. High current contact

New V shape contact were developed for mounting on boards with larger contact area while smaller through-holes. Even though a lot of on-board connection space is needed, through-holes were made as small as possible to make pattern design easily.

4. Audible Latching

On mating, an audible lock sound and sensation is transmitted to the assembler, so that even when working 'blind' mis-mating (or half-mating) problems are avoided.

5. Key

The housing has a keying (slit), so that by separating use of the X key and Y key mis-Mating is prevented.

D-4000 Series Performance and Specifications

Performance

Item \ Pitch	250mils 6.35mm
Rated Voltage	600V AC(rms)/DC
Rated Current	2P: 24A 3P: 23A 4P: 22A (AWG#12 for use as powersource)
Contact Resistance	10mff Max
Withstanding Voltage	2,500V AC(1 min)
Operating Temperature	-55°C ~+105°C

Positions/Wire Size/Rated Current

Unit: A(Amps)

Position	Wire Size(AWG)		
	12	14	16
2	24	21	16
3	23	20	15
4	22	19	14

Product Specification

Product Specifications	108-78182	
Applications Specifications	114-5369	
Hand tool application specification	Part number: 1762130-1 (M)	411-78174
	Part number: 1762129-1 (L)	411-78173
Unplugging tool (1762461-1) operating manual	411-78186	

When applicable, please be sure to order the operating manual. It can also be found in the online electronic specifications catalog.

Materials and Plating

Category	Materials	Plating
Receptacle Contact Tab Contact	Phosphor bronze or copper alloy	0.38µm gold-plating over Nickel under-plated
Board Mount Header	Phosphor bronze or copper alloy	Gold plating over Nickel under-plated Tin plating on tail side
Housing	UL94V-0, reinforced thermoplastic PBT with glass fiber	

Safety Standards

The safety specifications listed below are approved on specific part numbers. Please contact our Technical Support Centre to check whether the part numbers you use are approved or not. Keep in mind that there are instances where values differ from those given by Tyco Electronics Specifications.

Standard	Series	D-4200										
	Rated Voltage	Rated Current	Temperature Range									
Product Specifications 108-78182	600V AC/DC	24A AWG#12 2P	-55°C ~+105°C									
UL File No.E28476	Based on the requirements of Application	Based on the requirements of Application	-									
CSA Report No. LR 7189	600V AC/DC	24A	-									
TÜV License No. R 50084673	600V AC/DC	<table border="1"> <tr> <th>AWG</th> <th>A(2 P)</th> </tr> <tr> <td>12</td> <td>24</td> </tr> <tr> <td>14</td> <td>21</td> </tr> <tr> <td>16</td> <td>16</td> </tr> </table>	AWG	A(2 P)	12	24	14	21	16	16	-55°C ~+105°C	
AWG	A(2 P)											
12	24											
14	21											
16	16											

D-4000 Series Configurations

D-4200S

High Current

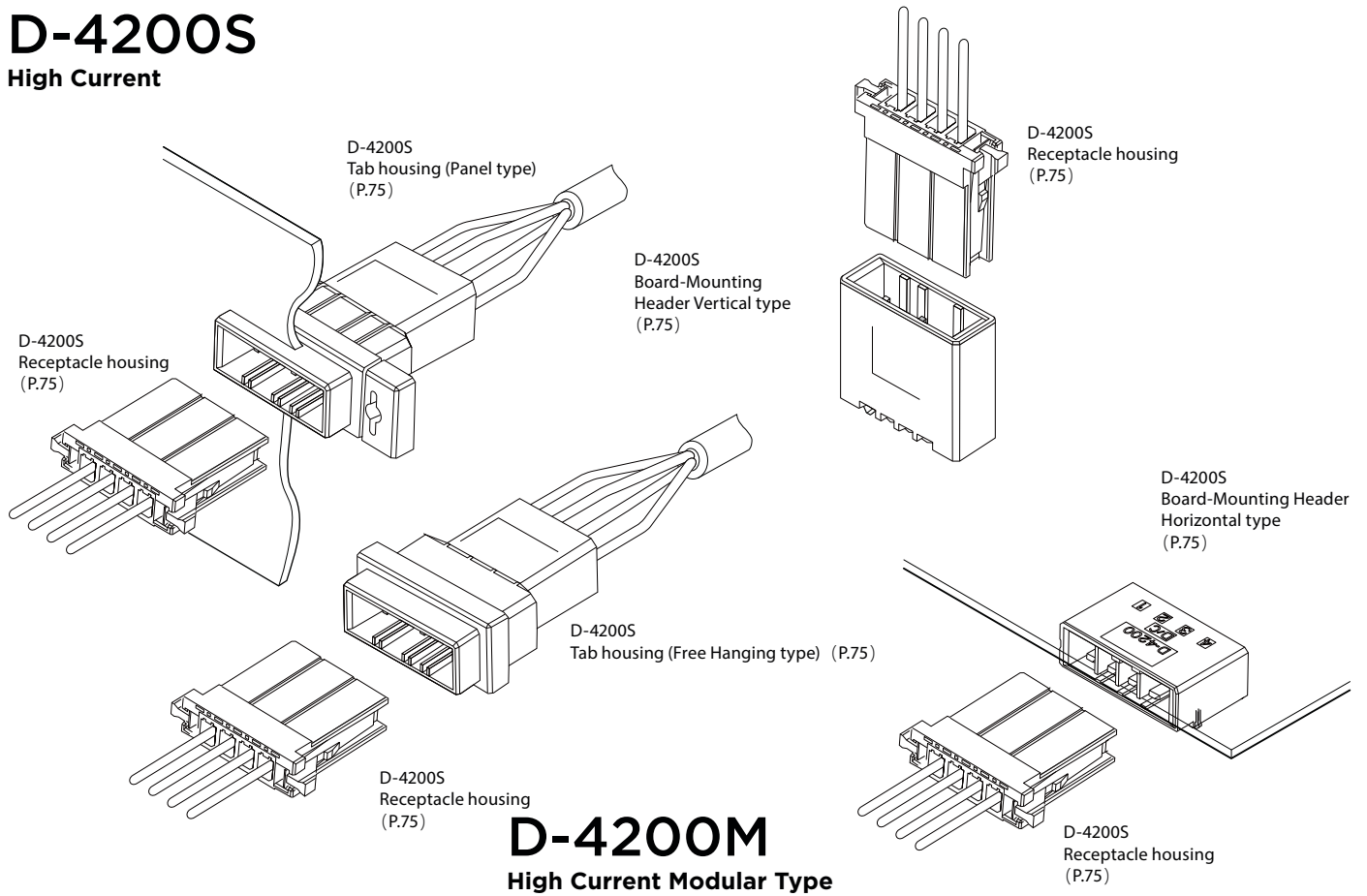

D-4200M

High Current Modular Type

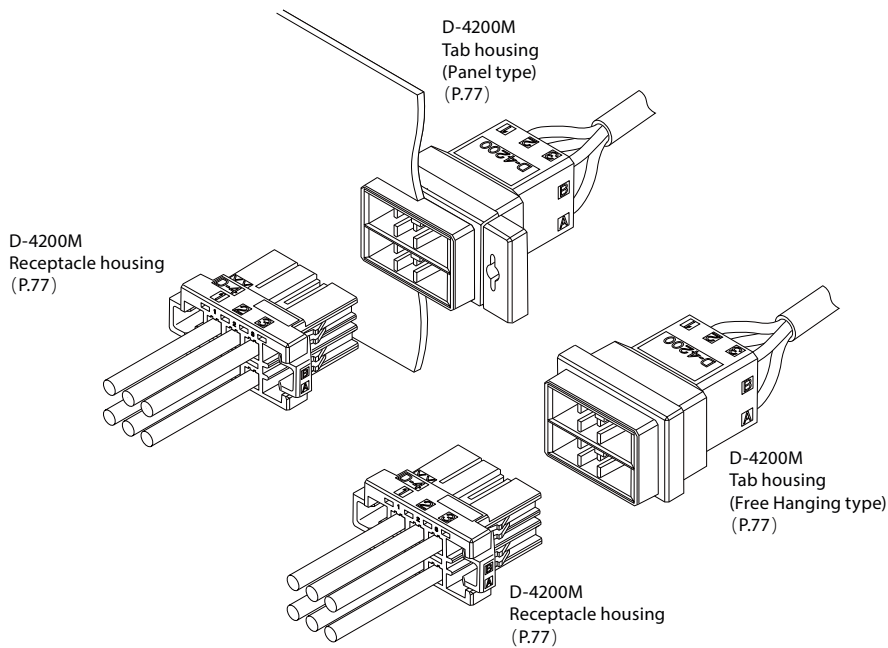

D-4000 Series Contact

■ Crimped Types

(Gold plating thickness 0.38 µm)

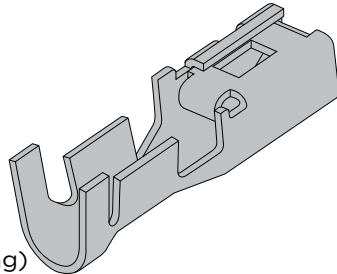

Receptacle Contact
(Used in Receptacle housing)

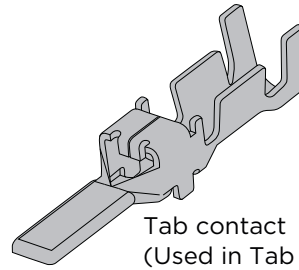

Tab contact
(Used in Tab housing)

Wire Range		Outside Diameter of Insulation mm	Wire Range Mark	Contacts						Applicable tools	
				Receptacle Contact		Tab Contact		Sequential LongTab contacts		Hand tool CCII hand tool PEW12 hand tool* PEW12 dice only	Mini-Applicator
AWG	mm ²			Strip form	Loose Piece	Strip form	Loose Piece	Strip form	Loose Piece		
22	0.30	1.58-2.38	SS*	2287721-2	2288020-1	2287732-2	2288019-1	1-2287732-2	1-2288019-1	---	---
20	0.50	1.76-2.56									
20	0.50	1.8-2.7	S	2040015-2	2040587-1	2040016-2	2040586-1	1-2040016-1	1-2040586-1	2266289-1	2047670-1
18	0.85										
16	1.42										
16	1.25	2.0-3.2 2.8-3.75	M	1747418-2	1747499-2	1747419-2	1747501-2	1-1747419-2	1-1747501-2	1762130-1 1762671-1* (1762675-1)	1762120-2
14	2.20										
14	2.20	2.9-3.8 3.8-4.2	L	1747415-2	1747498-2	1747416-2	1747500-2	1-1747416-2	1-1747500-2	1762129-1 1762670-1* (1762674-1)	1762119-2
12	3.50										

Note * The gold plating thickness of the corresponding terminal is 0.76 µm, and the gold plating thickness of the corresponding terminal of which the wire diameter and model are not noted.

Please contact our sales department or distributor for more information.

Strip Form contacts are used with Mini-applicators (bench machine) and Loose-Piece contacts are with hand tools.

PEW 12 is an exchange-type hand tool. *refers to the exchange-type hand tool with product number - 9-1478240-0

The receptacle contact can be used in all receptacle housings, the tab contact can be used in all tab housings. Details of the applicable tool are available from P. 107-111.

NOTE: all products are RoHS compliant On selection.

D-4200S Single-row High Voltage

Type Chart

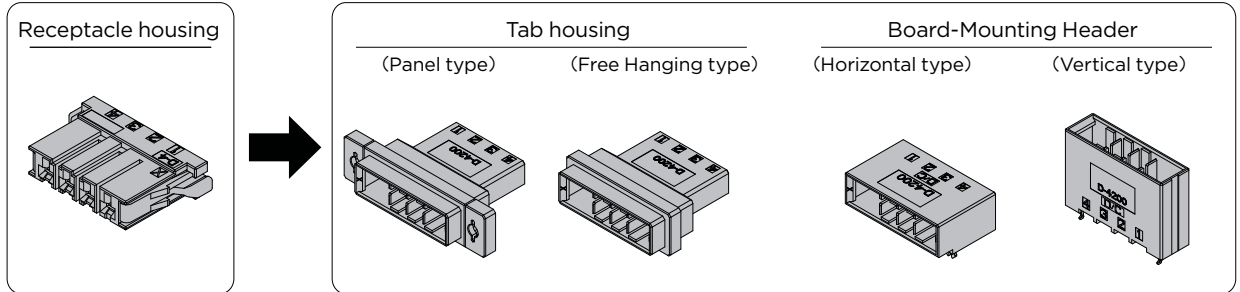

Pos	Color	Key	Receptacle housing	Tab housing		Plating	Board-Mounting Header			
				Panel type	Free Hanging type		Horizontal type		Vertical type	
							Standard	Sequential	Standard	Sequential
2	Black	X	1-1747276-2	1-1747535-2	1-1747414-2	Gold	1-1903328-2	—	1-1747277-2	—
	Black	Y	2-1747276-2	2-1747535-2	2-1747414-2	Gold	2-1903328-2	—	2-1747277-2	—
3	Black	X	1-1747276-3	1-1747535-3	1-1747414-3	Gold	1-1903328-3	5-1903328-3	1-1747277-3	5-1747277-3
	Black	Y	2-1747276-3	2-1747535-3	2-1747414-3	Gold	2-1903328-3	6-1903328-3	2-1747277-3	6-1747277-3
4	Black	X	1-1747276-4	1-1747535-4	1-1747414-4*	Gold	1-1903328-4	5-1903328-4	1-1747277-4	5-1747277-4
	Black	Y	2-1747276-4	2-1747535-4	2-1747414-4*	Gold	2-1903328-4	6-1903328-4	2-1747277-4	6-1747277-4

*DIN rail attachment is available, P/N 2822901-1

Relative Product Information

Applicable contact...P.74

Performance & Specifications...P.72

Applications

Example of Robot/Robot Controller Application

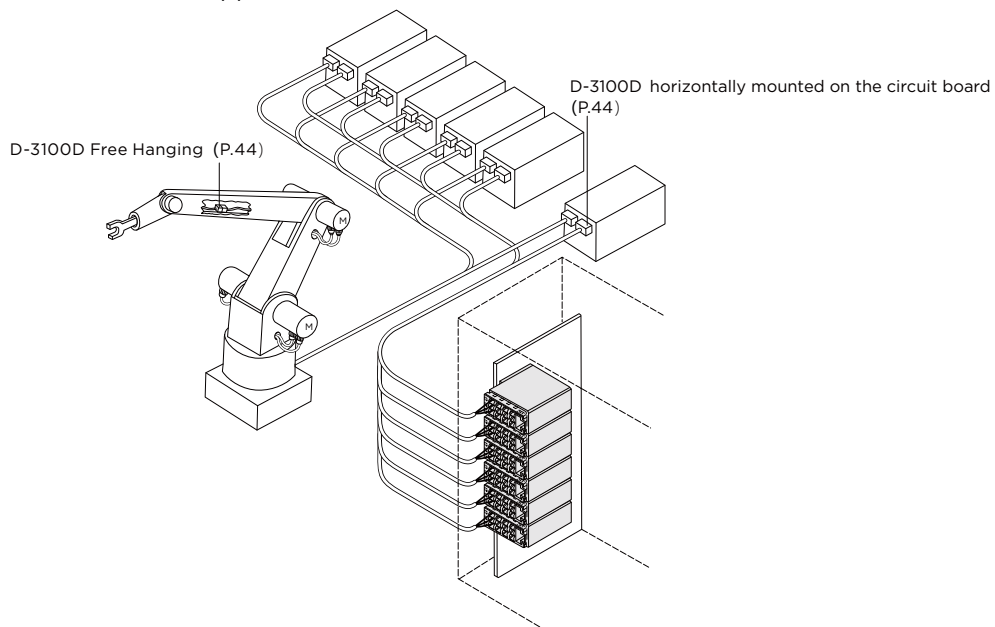

NOTE: all products are RoHS compliant On selection.

D-4200S Single-row High Voltage

Mated Dimension

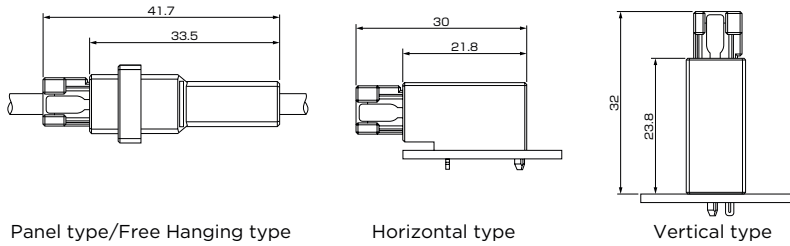

Panel type/Free Hanging type

Horizontal type

Vertical type

External Dimensions

Receptacle Housing

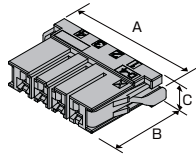

Pos	Key	Color	Part Number	Dimensions		
				A	B	C
2	X	Black	1-1747276-2	27.4	23.0	8.5
	Y	Black	2-1747276-2			
3	X	Black	1-1747276-3	33.7	23.0	8.5
	Y	Black	2-1747276-3			
4	X	Black	1-1747276-4	40.1	23.0	8.5
	Y	Black	2-1747276-4			

Tab Housing

Panel type

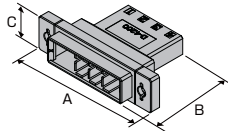

Pos	Key	Color	Part Number	Dimensions		
				A	B	C
2	X	Black	1-1747535-2	40.0	33.5	13.8
	Y	Black	2-1747535-2			
3	X	Black	1-1747535-3	46.0	33.5	13.8
	Y	Black	2-1747535-3			
4	X	Black	1-1747535-4	53.0	33.5	13.8
	Y	Black	2-1747535-4			

Free Hanging type

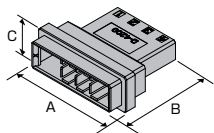

Pos	Key	Plating	Color	Part Number	Dimensions		
					A	B	C
2	X	—	Black	1-1747414-2	26.4	33.5	13.8
	Y	—	Black	2-1747414-2			
3	X	—	Black	1-1747414-3	32.7	33.5	13.8
	Y	—	Black	2-1747414-3			
4	X	—	Black	1-1747414-4	39.1	33.5	13.8
	Y	—	Black	2-1747414-4			

NOTE: all products are RoHS compliant On selection.

Board-Mounting Header

Horizontal type

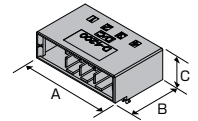

Pos	Key	Plating	Color	Part Number	Dimensions		
					A	B	C
2	X	Gold	Black	1-1903328-2	22.4	21.8	11.9
	Y	Gold	Black	2-1903328-2			
3	X	Gold	Black	1-1903328-3	28.7	21.8	11.9
	Y	Gold	Black	2-1903328-3			
	X	Gold	Black	5-1903328-3×1			
	Y	Gold	Black	6-1903328-3×1			
4	X	Gold	Black	1-1903328-4	35.1	21.8	11.9
	Y	Gold	Black	2-1903328-4			
	X	Gold	Black	5-1903328-4×1			
	Y	Gold	Black	6-1903328-4×1			

×1 Sequential type

Vertical type

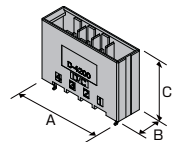

Pos	Key	Plating	Color	Part Number	Dimensions		
					A	B	C
2	X	Gold	Black	1-1747277-2	22.4	10.4	23.8
	Y	Gold	Black	2-1747277-2			
3	X	Gold	Black	1-1747277-3	28.7	10.4	23.8
	Y	Gold	Black	2-1747277-3			
	X	Gold	Black	5-1747277-3×1			
	Y	Gold	Black	6-1747277-3×1			
4	X	Gold	Black	1-1747277-4	35.1	10.4	23.8
	Y	Gold	Black	2-1747277-4			
	X	Gold	Black	5-1747277-4×1			
	Y	Gold	Black	6-1747277-4×1			

×1 Sequential type

D-4200M Double-row High Current Modular Type

Type Chart

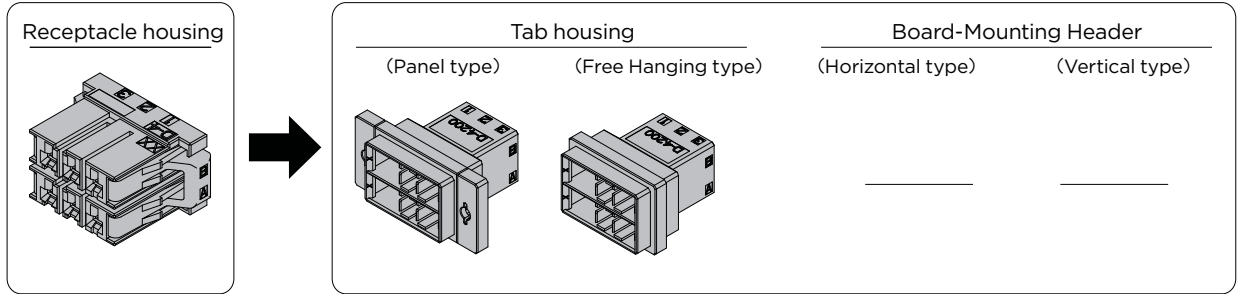

Pos	Color	Key	Receptacle housing	Tab housing		Plating	Board-Mounting Header	
				Panel type	Free Hanging type		Horizontal type	Vertical type
6	Black	XX	1-1903329-3	1-1903331-3	1-1903330-3	—	—	—
	Black	YY	2-1903329-3	2-1903331-3	2-1903330-3	—	—	—
	Black	XY	3-1903329-3	3-1903331-3	3-1903330-3	—	—	—

Relative Product Information

Applicable contact...P.74
Performance & Specifications...P.72

Mated Dimension

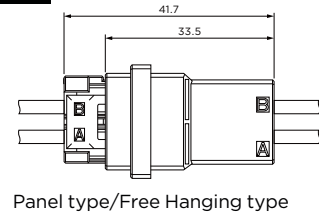

Panel type/Free Hanging type

External Dimensions

Receptacle Housing

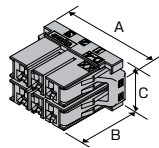

Pos	Key	Color	Part Number	Dimensions		
				A	B	C
6	XX	Black	1-1903329-3	33.7	23.0	17.3
	YY	Black	2-1903329-3			
	XY	Black	3-1903329-3			

Tab Housing

Panel type

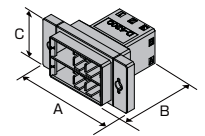

Pos	Key	Color	Part Number	Dimensions		
				A	B	C
6	XX	Black	1-1903331-3	46.0	33.5	22.6
	YY	Black	2-1903331-3			
	XY	Black	3-1903331-3			

Free Hanging type

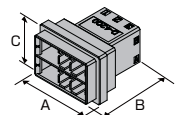

Pos	Key	Color	Part Number	Dimensions		
				A	B	C
6	XX	Black	1-1903330-3	32.7	33.5	22.6
	YY	Black	2-1903330-3			
	XY	Black	3-1903330-3			

NOTE: all products are RoHS compliant On selection.

D-5000 Series

Series introduction

The Dynamic 5000 series was developed for up to 45 amperes in response to the demand for improved reliability and productivity for the main power lines in equipment.

They can be used for a variety of applications as replacements for terminal blocks, or round terminals. It is compact but with a high current capacity.

In addition, it has a wide variety of housings to cover all applications from PCB to internal wiring distributions. The D-5000 series is right for high current power line applications where reliability cannot rely on operator's skills

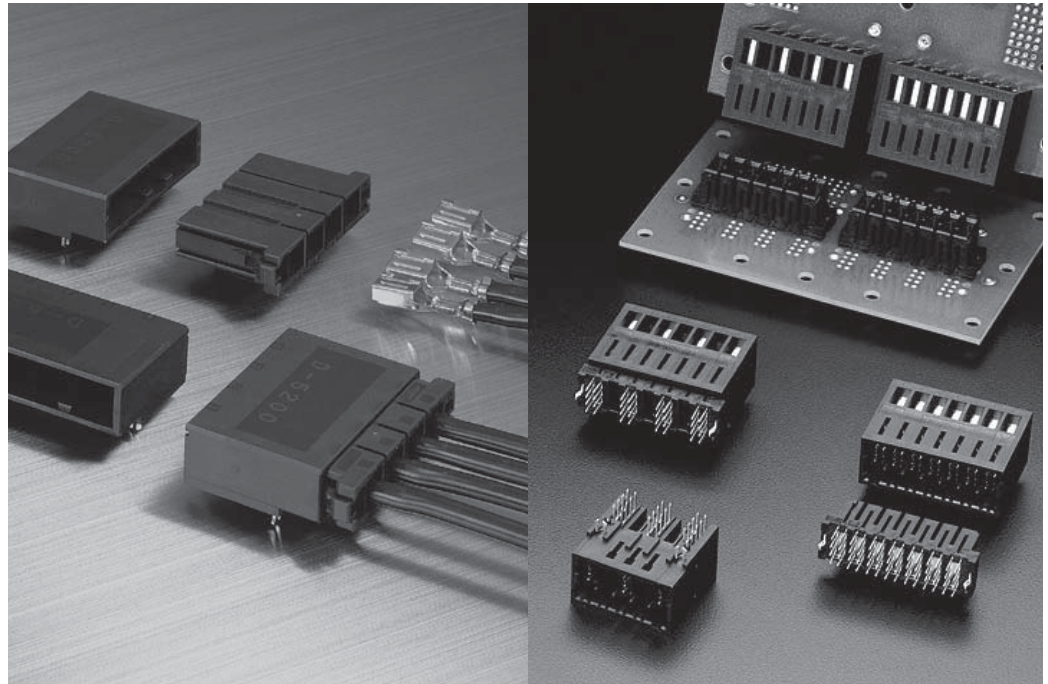

Product Features

1. High Current Contact

The D-5000 series uses the same 'twis-resistant, box shape contact' as the rest of the Dynamic series contacts. The material is the same copper alloy developed for the D-3000 series with its superior elasticity and conductivity, which results in a reliable, robust contact capable of high current. Silver plating is also available for high amperage applications.

2. Sequential Connection

The Sequential Mating means that the build up of static charge in the sequential contact is grounded first at mating. The long tab was developed for sequential connection of tab contacts. By using both this long tab contact and standard tab contacts, sequential connectivity is enhanced.

3. Contact for High Amperage

The contact for on-board mounting are a newly developed twin-lead type. It is possible to reliably join patterns and connectors because a wide area of PCBs can be allocated. New V shape contacts were developed for mounting on boards. Even though a lot of on-board connection space is needed, through-holes were made as small as possible to make pattern design easily (patent pending).

4. IP20 (Protection from the approach of the finger)

D-5300 is recommended for applications with a supply side in the IP20 apparatus. By using a housing on the apparatus side (panel side) which can accommodate the receptacle contact, the apparatus side connector meets IP20 requirement.

D-5000 Series Performance and Specifications

Performance

Item	D-5200	D-5300	D-5200α
Pitch	10.16mm		
Rated Current	Maximum: 35A		Maximum: 45A
Rated Voltage	630V AC / DC		
Withstanding Voltage	3000 VAC		
Total resistance	Maximum: 2mff		
Insertion strength:	Maximum (per position): 9.8N		
Withdrawal strength	Minimum (per position): 1.96N		
Durability	50 cycles (0.76 μm Gold)		
Locking strength	Minimum: 98N		

Position/Wire Size/Rated Current

Unit: A(Amps)

Pos	Series	Wire Size(AWG)						
		20	18	16	14	12	10	8
6	D-5200	—	—	16	19	25	30	—
4	D-5300	—	—	—	—	—	—	—
3	D-5200α	12	16	20	25	33	38	45
4		12	15	18	23	31	35	43

Performance Specifications

Product Specifications	108-5453	
Test Report	501-5188	
Applications Specifications	114-5206	
Hand tool manual	Part number: 234170-1	411-5712
	Part number: 234171-1	411-5713
	Part number: 91596-1	408-8547-1
	Part number: 1366044-1	411-5976
Unplugging tool (model: 409158-1) operation manual	411-5774	

When applicable, please be sure to order the operating manuals. It can also be found in the online electronic specifications catalog.

Material and Plating

Category	Item	D-5200	D-5300	D-5200α
Receptacle Contacts Tab Contact	Materials	Copper alloys		
	Plating	Gold Plating with Nickel under-plated	Gold/Silver Plating with Nickel under-plated	Gold Plating with Nickel under-plated
Board Mount Header	Materials	Copper alloys	—	Copper alloy
	Plating	Gold Plating with Nickel under-plated	—	Gold Plating with Nickel under-plated
Housing	Materials	UL94V-0, glass fiber reinforced thermoplastic PBT		

Safety Standards

The safety specifications listed below are approved on specific part numbers. Please contact our Technical Support Centre to check whether the part numbers you use are approved or not. Keep in mind that there are instances where values differ from those given by Tyco Electronics Specifications.

ST.D.	Series	D-5200Series(10.16mmPitch)			D-5200MαSeries																																						
		Rated Voltage	Rated Current	Temperature Range	Rated Voltage	Rated Current	Temperature Range																																				
Product Specifications 108-5453		630V AC/DC	(As shown above)	-55°C ~+105°C	—	(As shown above)	-55°C ~+105°C																																				
UL File No.E28476 (Recognized Component)		Based on the requirements of application	Based on the requirements of application	—	—	Based on the requirements of application	—																																				
CSA Report No. LR 7189		600V AC/DC	<table border="1"> <thead> <tr> <th>AWG</th> <th>A</th> </tr> </thead> <tbody> <tr><td>16</td><td>13</td></tr> <tr><td>14</td><td>18</td></tr> <tr><td>12</td><td>25</td></tr> <tr><td>10</td><td>30</td></tr> </tbody> </table>	AWG	A	16	13	14	18	12	25	10	30	—	—	—	—																										
AWG	A																																										
16	13																																										
14	18																																										
12	25																																										
10	30																																										
TÜV License No. R9650368 IP protection level IP-10 Overvoltage type (II) 50 cycles of repeated plugging and unplugging		600V AC/DC	<table border="1"> <thead> <tr> <th>AWG</th> <th>A</th> </tr> </thead> <tbody> <tr><td>16</td><td>15</td></tr> <tr><td>14</td><td>20</td></tr> <tr><td>12</td><td>25</td></tr> <tr><td>10</td><td>30</td></tr> </tbody> </table>	AWG	A	16	15	14	20	12	25	10	30	-30°C ~+105°C	—	<table border="1"> <thead> <tr> <th rowspan="2">AWG</th> <th colspan="2">A</th> </tr> <tr> <th>1-10P</th> <th>4-No of Pos.</th> </tr> </thead> <tbody> <tr><td>20</td><td>12.5</td><td>12.5</td></tr> <tr><td>18</td><td>17.5</td><td>16</td></tr> <tr><td>16</td><td>21</td><td>19.5</td></tr> <tr><td>14</td><td>26</td><td>24</td></tr> <tr><td>12</td><td>33</td><td>31</td></tr> <tr><td>10</td><td>40</td><td>37.5</td></tr> <tr><td>8</td><td>48</td><td>46</td></tr> </tbody> </table>	AWG	A		1-10P	4-No of Pos.	20	12.5	12.5	18	17.5	16	16	21	19.5	14	26	24	12	33	31	10	40	37.5	8	48	46	-30°C ~+105°C
AWG	A																																										
16	15																																										
14	20																																										
12	25																																										
10	30																																										
AWG	A																																										
	1-10P	4-No of Pos.																																									
20	12.5	12.5																																									
18	17.5	16																																									
16	21	19.5																																									
14	26	24																																									
12	33	31																																									
10	40	37.5																																									
8	48	46																																									

D-5000 Series Configurations

D-5200S

Single-row High Voltage Type

D-5200S Board-Mounting Header Vertical type (P.82)

D-5200S Free Hanging type (P.82)

D-5200S Tab Housing Panel type (P.82)

D-5200M α Board-Mounting Header Horizontal type (P.90)

D-5200S Receptacle Housing Panel type (P.82)

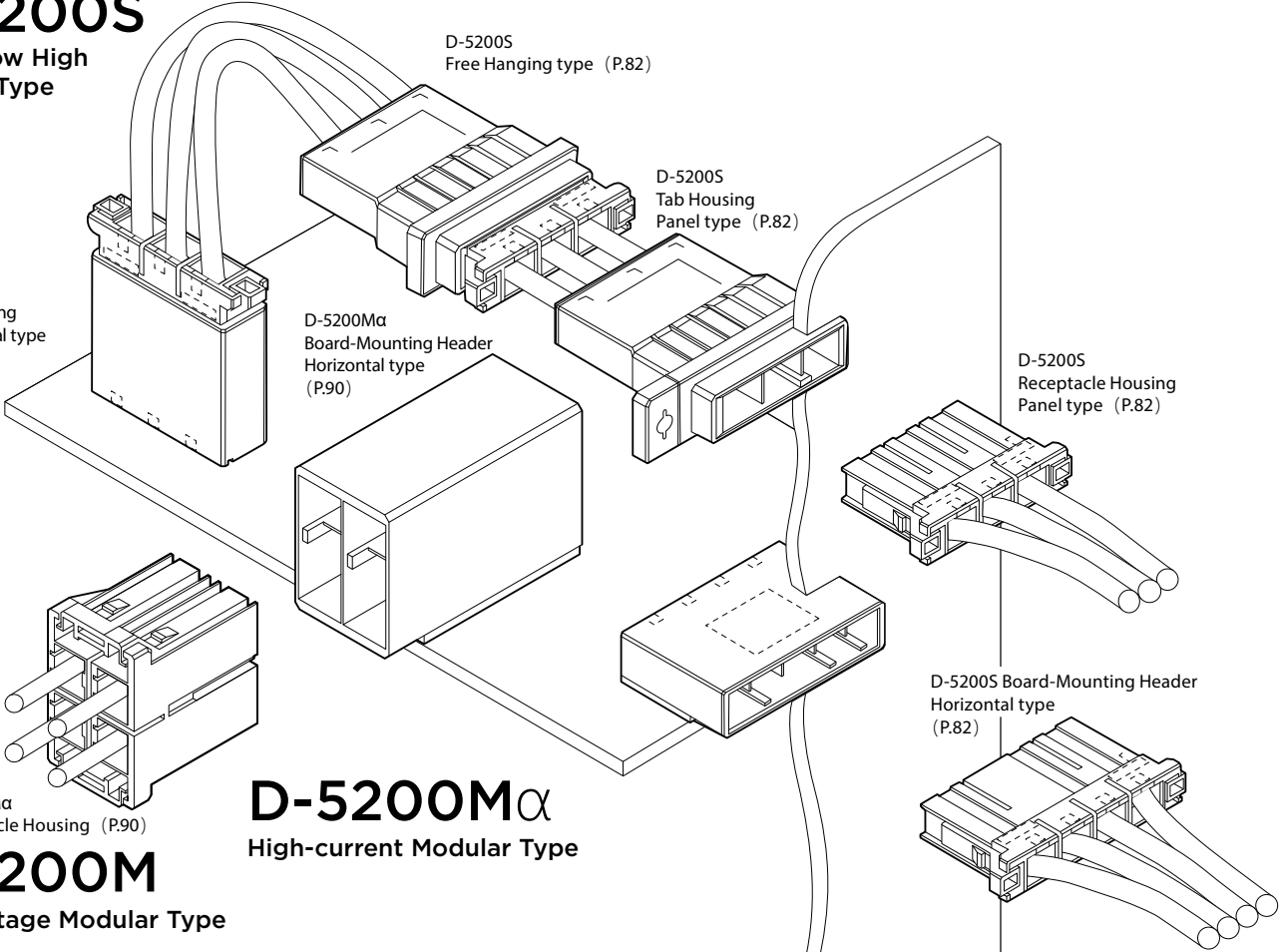

D-5200M α Receptacle Housing (P.90)

D-5200M α

High-current Modular Type

D-5200M

High-voltage Modular Type

D-5200M Board-Mounting Header Vertical type (P.84)

D-5200M Free Hanging type (P.84)

D-5200M Board-Mounting Header Horizontal type (P.84)

D-5200M Tab Housing Panel type (P.84)

D-5200M Receptacle Housing Panel type (P.84)

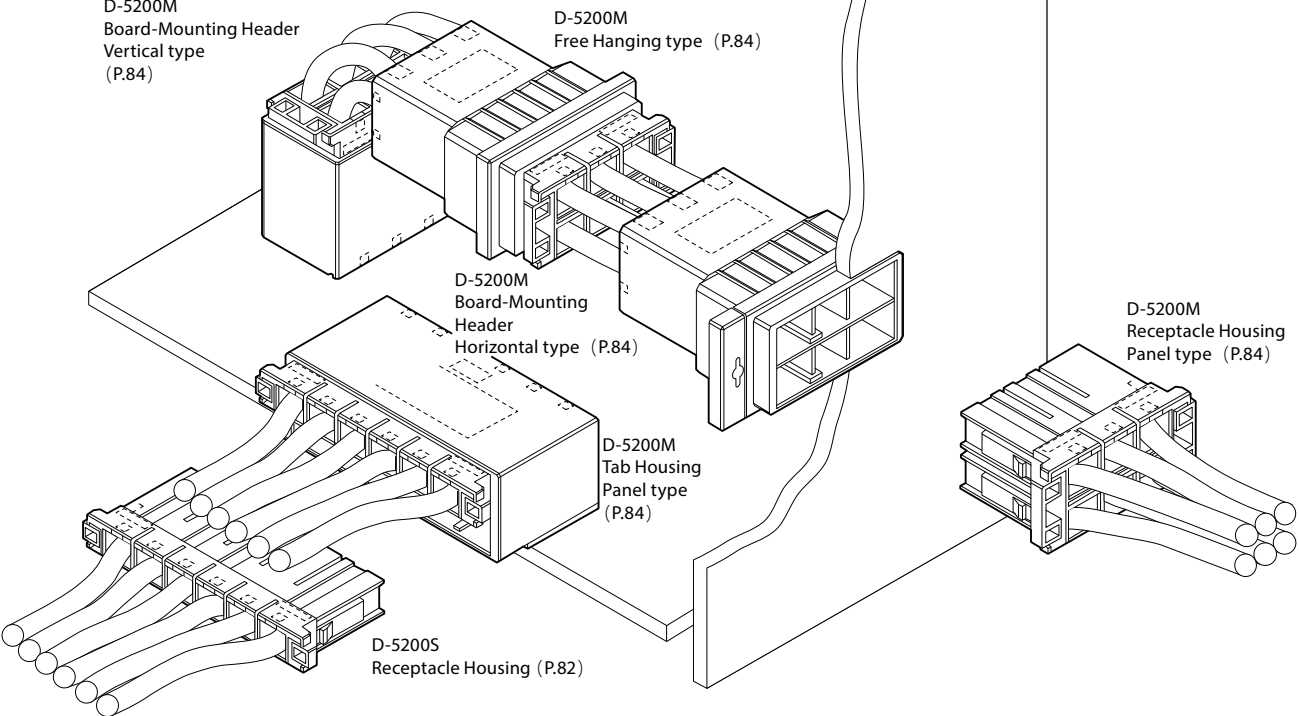

D-5000 Series Contact

■ Crimped Types

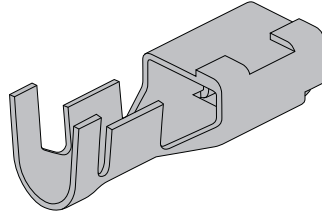

Receptacle Contact
(used in Receptacle Housing)

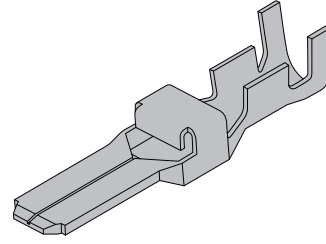

Tab contact
(used in Tab Housing)

•GoldPlating

Terminal

Applicable Wire Range		Outside Diameter of Insulation mm	Wire Range Mark	Contacts						Applicable tools			
AWG	mm ²			Receptacle Contact		Tab Contact		Long sequential contacts		Manual Hand Tools	Electric Hydraulic Tool※1	Mold ※2	Mini-Application Tool
				Strip form	Loose Piece	Strip form	Loose Piece	Strip form	Loose Piece				
20	0.50	1.8-2.83	SS	1318985-□	1318986-□	—	—	—	—	91596-1	—	—	※1
16	1.25	2.35-3.23		179955-□	316040-□	917802-□	917804-□	84696-1	2013594-1	234170-1	—	2155822-1	2266273-2
16	1.25	3-3.80	S	179956-□	316041-□	917803-□	917805-□	84695-1	2013593-1	234171-1	2155369-1	2155503-1	2151086-2
14	2.20			1318696-□	1318697-□	1981690-□	1981691-□	2174021-1	2174022-1	1366044-1			
12	3.50	4-5.2	M	1318696-□	1318697-□	1981690-□	1981691-□	2174021-1	2174022-1	1366044-1	2155502-1	2266274-2	
10	5.50			1318696-□	1318697-□	1981690-□	1981691-□	2174021-1	2174022-1	1366044-1	2155502-1	2266274-2	
8	8.00	4.9-7.8	L	1318696-□	1318697-□	1981690-□	1981691-□	2174021-1	2174022-1	1366044-1	2155502-1	2266274-2	

Note Plating code

- 2: Gold plating of 0.38 μm in thickness
- 6: Silver plating of 2.54 μm in thickness
- 3: Gold plating of 0.76 μm in thickness
- 1: Gold plating of 0.2 μm in thickness

Please contact the sales department for mini applications tools.

Strip Form contacts are used with Mini-applicators (bench machine) and Loose-Piece contacts are with hand tools.

For details, please contact the purchase agent or sales department.

※1 See P. 107.

If you have any questions, please contact the AT tooling sales department.

※2 Used together with the electric hydraulic tool 2155369-1

The receptacle contact can be used in all receptacle housings, the tab contact can be used in all tab housings. Details of the applicable tool are available from P. 107-111.

NOTE: all products are RoHS compliant On selection.

D-5200S Single-Row High Current Type

Type Chart

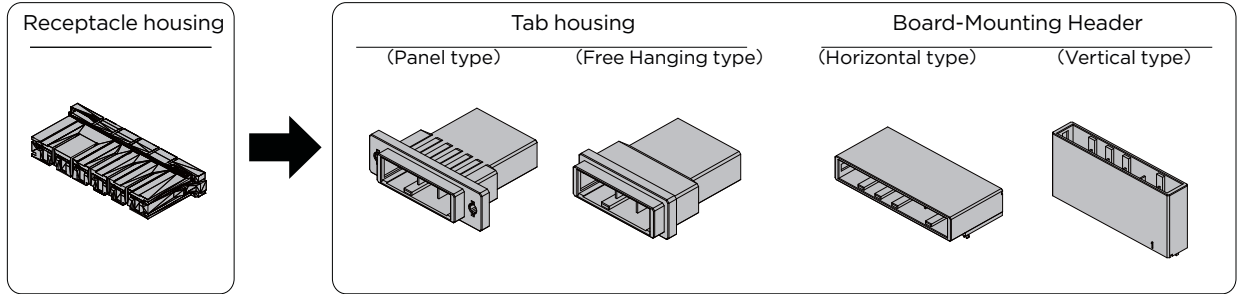

Pos	Color	Key	Receptacle housing	Tab housing		Plating	Board-Mounting Header					
				Panel type	Free Hanging type		Horizontal type		Vertical type			
							Standard	Sequential	Standard	Sequential		
2	Black	X	1-179958-2	1-353047-2	1-353046-2	Gold	1-353079-2	—	1-353080-2	—		
	Black					1-353079-3	—	1-353080-3	—			
	Black					—	—	6-353080-2	—			
	Black	Y	2-179958-2	2-353047-2	2-353046-2	Gold	—	—	2-353080-2	—		
	Black					—	—	2-353080-3	—			
	Gold					—	—	—	—			
3	Black	X	1-179958-3	1-353047-3	1-353046-3	Gold	1-353081-2	8-353081-2	1-353082-2	8-353082-2		
	Black					1-353081-3	—	1-353082-3	—			
	Black					—	—	—	—			
	Black	Y	2-179958-3	2-353047-3	2-353046-3	Gold	2-353081-2	—	2-353082-2	—		
	Black					2-353081-3	—	2-353082-3	—			
	Gold					—	—	—	—			
4	Black	X	1-179958-4	4P or 6P Wire-to-wire connectors are available in D5200M, see P.84		Gold	1-917541-2	8-917541-2	1-917542-2	8-917542-2		
	Black		1-917541-3			—	1-917542-3	—				
	Black	Y	2-179958-4			Gold	2-917541-2	—	2-917542-2	—		
	Black					—	—	2-917542-3	—			
6	Black	X	1-179958-6			4P or 6P Wire-to-wire connectors are available in D5200M, see P.84		Gold	1-179959-2	—	1-179960-2	—
	Black							1-179959-3	—	1-179960-3	—	
	Black							—	—	6-179960-2	—	
	Black	Y	2-179958-6					Gold	2-179959-2	—	2-179960-2	—
	Black			2-179959-3	—			2-179960-3	—			
	Black			—	—			7-179960-2	—			

Relative Product Information

Applicable contact...P.81
 Performance & Specifications...P.79

Mated Dimension

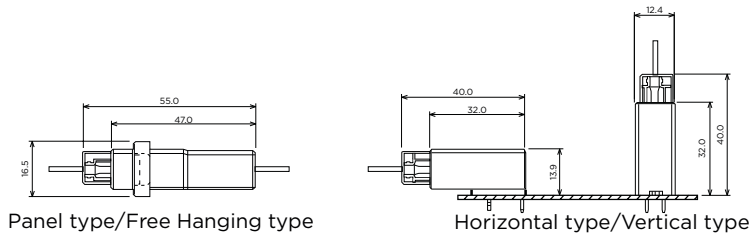

NOTE: all products are RoHS compliant On selection.

D-5200S Single-Row High Current Type

External Dimensions

■ Receptacle Housing

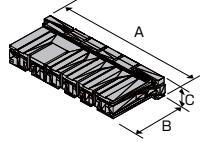

Pos	Key	Color	Part Number	Dimensions		
				A	B	C
2	X	Black	1-179958-2	35.8	29.0	9.8
	Y	Black	2-179958-2			
3	X	Black	1-179958-3	46.0	29.0	9.8
	Y	Black	2-179958-3			
4	X	Black	1-179958-4	53.7	29.0	9.8
	Y	Black	2-179958-4			
6	X	Black	1-179958-6	74.0	29.0	9.8
	Y	Black	2-179958-6			

■ Tab Housing

Panel type

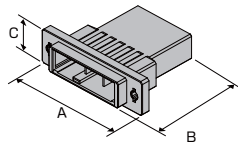

Pos	Key	Color	Part Number	Dimensions		
				A	B	C
2	X	Black	1-353047-2	47.0	47.0	16.5
	Y	Black	2-353047-2			
3	X	Black	1-353047-3	57.0	47.0	16.5
	Y	Black	2-353047-3			

Free Hanging type

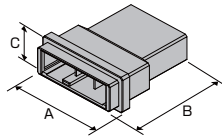

Pos	Key	Color	Part Number	Dimensions		
				A	B	C
2	X	Black	1-353046-2	33.4	47.0	16.5
	Y	Black	2-353046-2			
3	X	Black	1-353046-3	43.6	47.0	16.5
	Y	Black	2-353046-3			

NOTE: all products are RoHS compliant On selection.

■ Board-Mounting Header

Horizontal type

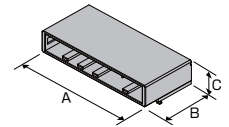

Pos	Key	Plating	Color	Part Number	Dimensions		
					A	B	C
2	X	Gold	Black	1-353079-2	29.4	32.0	13.9
		Gold	Black	1-353079-3			
3	X	Gold	Black	1-353081-2	39.5	32.0	13.9
		Gold	Black	8-353081-2※			
		Gold	Black	1-353081-3			
	Y	Gold	Black	2-353081-2			
4	X	Gold	Black	1-917541-2	49.7	32.0	13.9
		Gold	Black	8-917541-2※			
	Y	Gold	Black	1-917541-3			
6	X	Gold	Black	1-179959-2	70.0	32.0	13.9
		Gold	Black	1-179959-3			
	Y	Gold	Black	2-179959-2			
	Y	Gold	Black	2-179959-3			

※Sequential

Vertical type

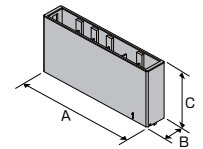

Pos	Key	Plating	Color	Part Number	Dimensions		
					A	B	C
2	X	Gold	Black	1-353080-2	29.4	12.4	32.0
		Gold	Black	1-353080-3			
	Y	Gold	Black	6-353080-2			
		Gold	Black	2-353080-2			
3	X	Gold	Black	1-353082-2	39.5	12.4	32.0
		Gold	Black	8-353082-2※			
		Gold	Black	1-353082-3			
	Y	Gold	Black	2-353082-2			
4	X	Gold	Black	1-917542-2	49.7	12.4	32.0
		Gold	Black	8-917542-2※			
	Y	Gold	Black	1-917542-3			
		Gold	Black	2-917542-2			
6	X	Gold	Black	1-179960-2	70.0	12.4	32.0
		Gold	Black	1-179960-3			
		Gold	Black	6-179960-2			
	Y	Gold	Black	2-179960-2			
		Gold	Black	2-179960-3			
		Gold	Black	7-179960-2			

※Sequential

D-5200M Double-row High Current Modular Type

Type Chart

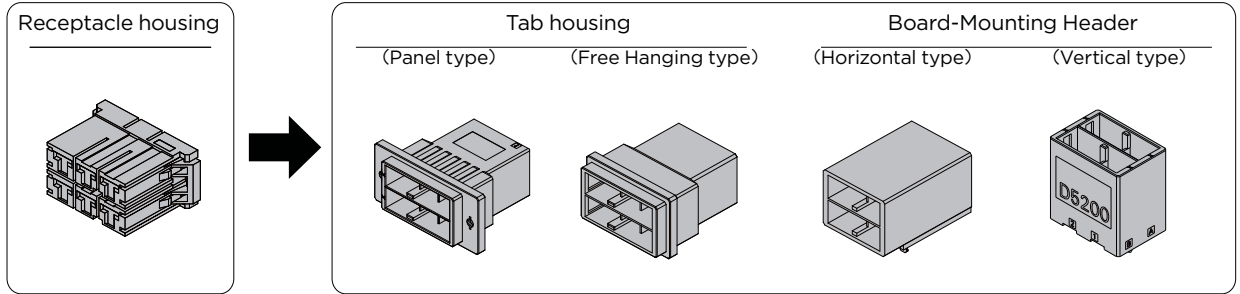

Pos	Color	Key	Receptacle housing	Tab housing		Plating	Board-Mounting Header			
				Panel type	Free Hanging type		Horizontal type		Vertical type	
							Standard	Sequential	Standard	Sequential
4	Black	XX	1-917807-2	1-917809-2	1-917808-2	Gold/silver	1-1123309-2	8-1123309-2	1-1981458-6	—
	Black	YY	2-917807-2	2-917809-2	2-917808-2	Gold/silver	2-1123309-2	—	2-1981458-6	—
	Black	XY	3-917807-2	3-917809-2	3-917808-2	Gold/silver	3-1123309-2	—	3-1981458-6	—
6	Black	XX	1-917807-3	1-917809-3	1-917808-3	—	—	—	1-2326092-2	—
	Black	YY	2-917807-3	2-917809-3	2-917808-3	—	—	—	2-2326092-2	—
	Black	XY	3-917807-3	3-917809-3	3-917808-3	—	—	—	3-2326092-2	—
8	Black	XX	—※1	—	—	Gold	1123829-1	—	—	—
	Black	YY	—	—	—	—	—	—	—	—
	Black	XY	—	—	—	—	—	—	—	—

※1: Use two 1-179958-4

Relative Product Information

Applicable contact...P.81

Performance & Specifications...P.79

Mated Dimension

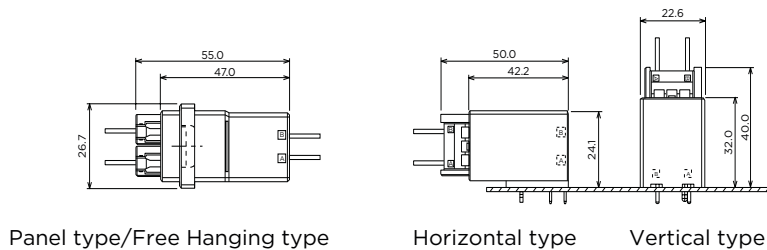

NOTE: all products are RoHS compliant On selection.

D-5200M Double-row High Current Modular Type

External Dimensions

■ Receptacle Housing

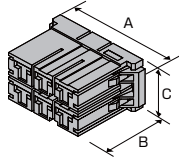

Pos	Key	Color	Part Number	Dimensions		
				A	B	C
4	XX	Black	1-917807-2	33.4	29.0	20.0
	YY	Black	2-917807-2			
	XY	Black	3-917807-2			
6	XX	Black	1-917807-3	43.5	29.0	20.0
	YY	Black	2-917807-3			
	XY	Black	3-917807-3			

■ Tab Housing

Panel type

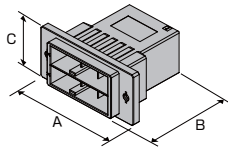

Pos	Key	Color	Part Number	Dimensions		
				A	B	C
4	XX	Black	1-917809-2	47.0	47.0	26.7
	YY	Black	2-917809-2			
	XY	Black	3-917809-2			
6	XX	Black	1-917809-3	57.0	47.0	26.7
	YY	Black	2-917809-3			
	XY	Black	3-917809-3			

Free Hanging type

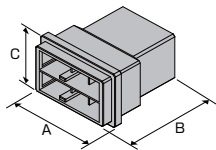

Pos	Key	Color	Part Number	Dimensions		
				A	B	C
4	XX	Black	1-917808-2	33.4	47.0	26.7
	YY	Black	2-917808-2			
	XY	Black	3-917808-2			
6	XX	Black	1-917808-3	43.6	47.0	26.7
	YY	Black	2-917808-3			
	XY	Black	3-917808-3			

NOTE: all products are RoHS compliant On selection.

■ Board-Mounting Header

Horizontal type

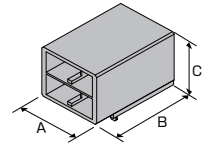

Pos	Key	Plating	Color	Part Number	Dimensions		
					A	B	C
4	XX	Gold	Black	1-1123309-2	29.4	42.2	24.1
	YY	Gold	Black	2-1123309-2			
	XY	Gold	Black	3-1123309-2			
8	XX	Gold	Black	1123829-1	49.7	32.0	26.3

Sequential type

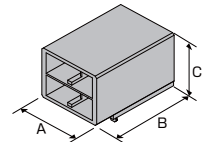

Pos	Key	Plating	Color	Part Number	Dimensions		
					A	B	C
4	XX	Gold	Black	8-1123309-2	29.4	42.2	24.1

Vertical type

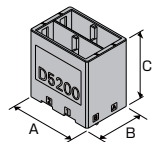

Pos	Key	Plating	Color	Part Number	Dimensions		
					A	B	C
4	XX	Silver	Black	1-1981458-6	29.4	22.6	32.0
	YY	Silver	Black	2-1981458-6			
	XY	Silver	Black	3-1981458-6			
6	XX	Gold	Black	1-2326092-2	39.5	22.6	32
	YY	Gold	Black	2-2326092-2			
	XY	Gold	Black	3-2326092-2			

D-5300 Reversed Mounting Type

Type Chart

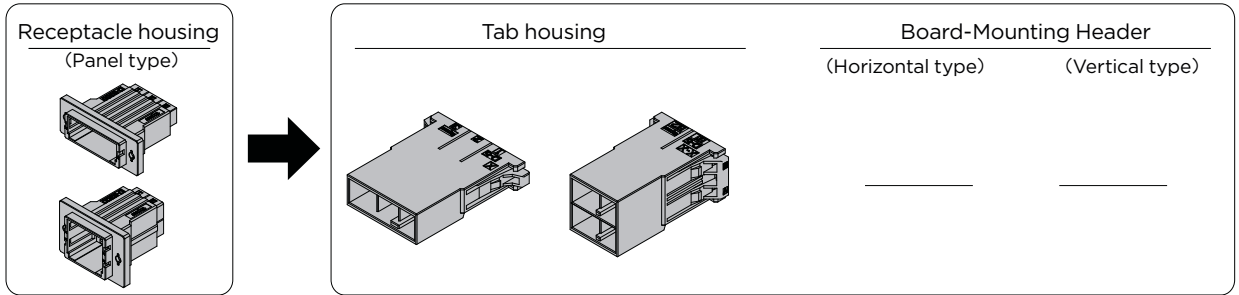

Pos	Color	Key	Receptacle housing	Tab housing	Plating	Board-Mounting Header	
			Panel type			Horizontal type	Vertical type
3	Black	X	1-1747821-3	1-1747819-3	—	—	—
	Black	Y	2-1747821-3	2-1747819-3	—	—	—
4	Black	XX	1-1747822-2	1-1747820-2	—	—	—
	Black	YY	2-1747822-2	2-1747820-2	—	—	—
	Black	XY	3-1747822-2	3-1747820-2	—	—	—

Relative Product Information

Applicable contact...P.81

Performance & Specifications...P.79

Mated Dimension

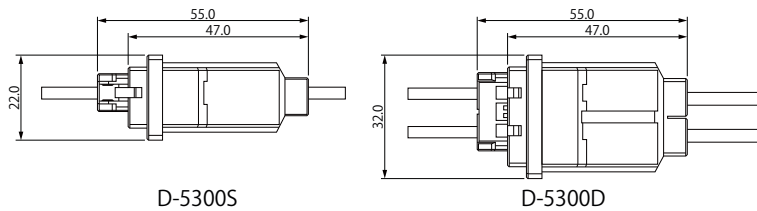

External Dimensions

Receptacle Housing

Panel Mount Type

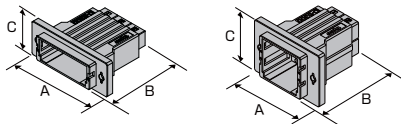

Pos	Key	Color	Part Number	Dimensions		
				A	B	C
3	X	Black	1-1747821-3	57.0	47.0	22.0
	Y	Black	2-1747821-3			
4	XX	Black	1-1747822-2	47.0	47.0	32.0
	YY	Black	2-1747822-2			
	XY	Black	3-1747822-2			

NOTE: all products are RoHS compliant On selection.

Tab Housing

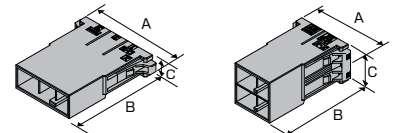

Pos	Key	Color	Part Number	Dimensions		
				A	B	C
3	X	Black	1-1747819-3	46.5	47.0	12.5
	Y	Black	2-1747819-3			
4	XX	Black	1-1747820-2	33.8	47.0	22.6
	YY	Black	2-1747820-2			
	XY	Black	3-1747820-2			

D-5200 Dyna-Tap 12P(4Px3 Row), 20P(4Px5 Row)

Type Chart

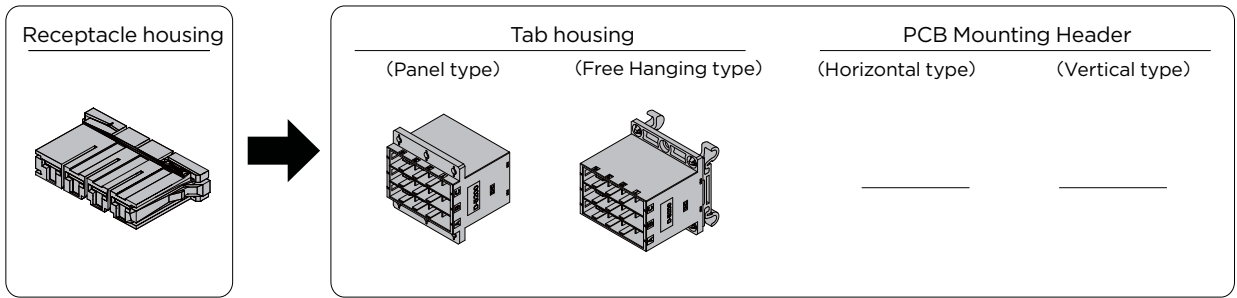

Pos	Color	Key	Receptacle housing	Tab housing		Plating	Board-Mounting Header	
				Panel type	DIN guide rail		Horizontal type	Vertical type
4	Black	—	1-179958-4	—	—	—	—	—
12	Black	—	—	1903146-1※1	1903146-3	Gold	—	—
12	Black	—	—	1903146-2※2	1-1903146-3	Gold	—	—
20	Black	—	—	2013285-1※1	—	Gold	—	—
	Black	—	—	2013285-2※2	2013285-3	Gold	—	—

※1:Front panel type ※2:Bottom panel type

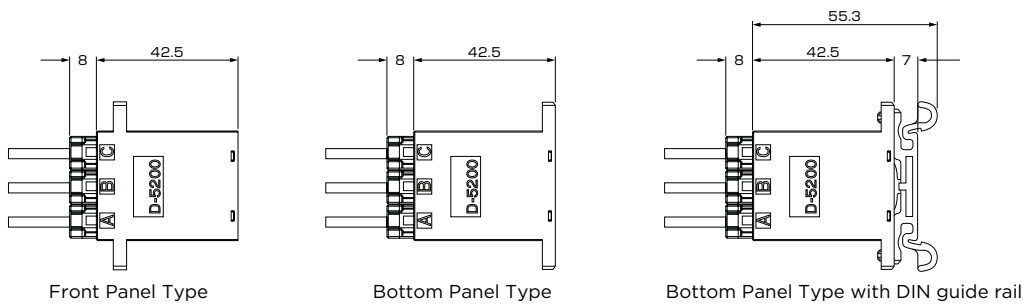

External Dimensions

Receptacle Housing

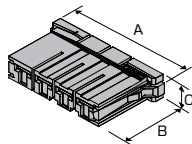

Pos	Key	Color	Part Number	Dimensions		
				A	B	C
4	—	Black	1-179958-4	53.7	29.0	9.8

Tab Housing

Panel type

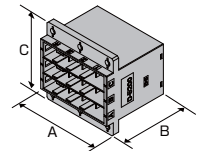
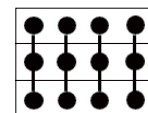

Pos	Key	Plating	Color	Part Number	Dimensions		
					A	B	C
12	—	Gold	Black	1903146-1	49.7	42.5	50.0
	—	Gold	Black	1903146-2			
20	—	Gold	Black	2013285-1	50.5	42.5	76.4
	—	Gold	Black	2013285-2			

DIN-rail type

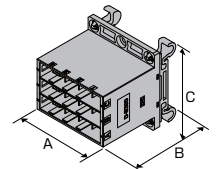

Pos	Key	Plating	Color	Part Number	Dimensions		
					A	B	C
12	—	Gold	Black	1903146-3	49.7	55.3	50.0
	—	Gold	Black	1-1903146-3			
20	—	Gold	Black	2013285-3	53.0	55.3	76.4

NOTE: all products are RoHS compliant On selection.

Dyna-Clamp Kit/ Cable Clamp Kit

Type Chart

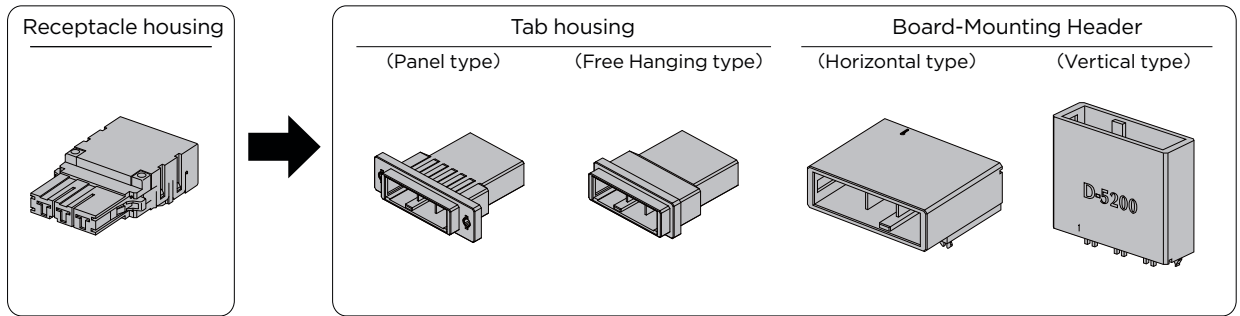

Pos	Key	Receptacle housing	Tab housing		Board-Mounting Header	
			Panel type	Free Hanging type	Horizontal type	Vertical type
3	—	1473668-1*	1-353047-3	1-353046-3	1-353081-2 1-353081-3	1-353082-2 1-353082-3
4	XX	1971239-1	1-917809-2	1-917808-2	1-1123309-2	1-1981458-6※
	YY	1971239-2	2-917809-2	2-917808-2	2-1123309-2	2-1981458-6※

※Silver-plated products
*Sequential type

Mated Dimension

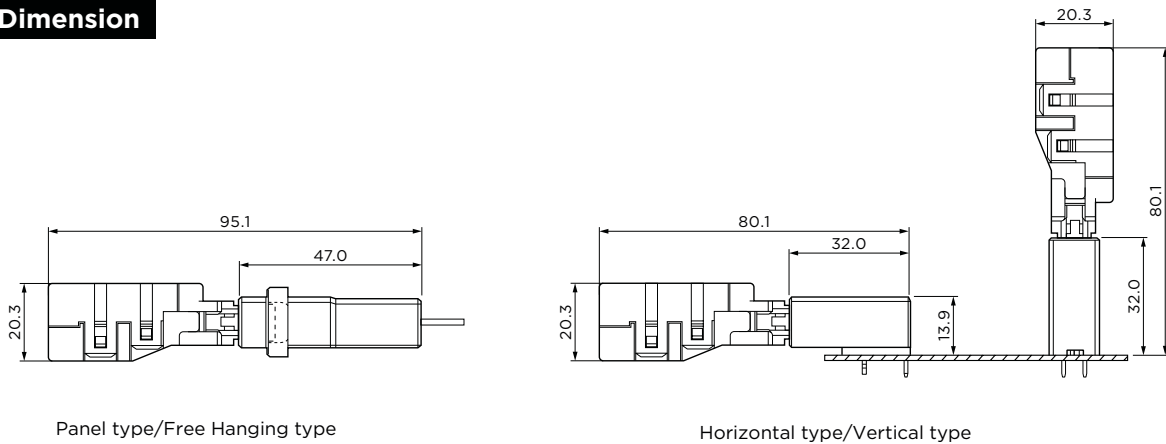

External Dimensions

Receptacle Housing

Single-row

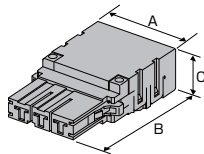

Double-row

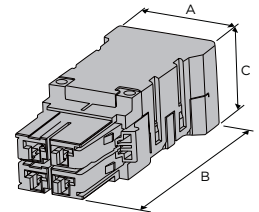

Pos	Key	Color	Part Number	Dimensions		
				A	B	C
3	—	Black	1473668-1	40.3	69.3	20.3

Pos	Key	Color	Part Number	Dimensions		
				A	B	C
4	XX	Black	1971239-1	36.0	81.2	29.0
	YY		1971239-2			

NOTE: all products are RoHS compliant On selection.

Dyna-Clamp Kit /Cable Clamp Kit

■ Tab Housing

Panel type

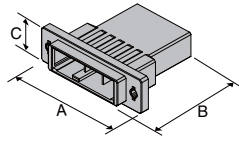

Pos	Key	Color	Part Number	Dimensions		
				A	B	C
3	X	Black	1-353047-3	57.0	47.0	12.1
4	XX	Black	1-917809-2	47.0	47.0	26.7
	YY	Black	2-917809-2			

Free Hanging type

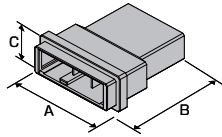

Pos	Key	Color	Part Number	Dimensions		
				A	B	C
3	X	Black	1-353046-3	43.6	47.0	12.1
4	XX	Black	1-917808-2	33.4	47.0	26.7
	YY	Black	2-917808-2			

NOTE: all products are RoHS compliant On selection.

■ Board-Mounting Header

Horizontal type

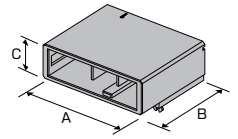

Pos	Key	Plating	Color	Part Number	Dimensions		
					A	B	C
3	X	Gold	Black	1-353081-2	39.5	32.0	13.9
		Gold	Black	1-353081-3			
4	XX	Gold	Black	1-1123309-2	29.4	42.2	24.1
		YY	Gold	Black			

Vertical type

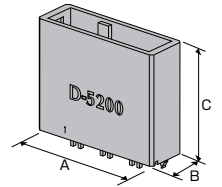

Pos	Key	Plating	Color	Part Number	Dimensions		
					A	B	C
3	X	Gold	Black	1-353082-2	39.5	12.4	32.0
		Gold	Black	1-353082-3			
4	XX	Silver	Black	1-1981458-6	29.4	22.6	32.0
		YY	Silver	Black			

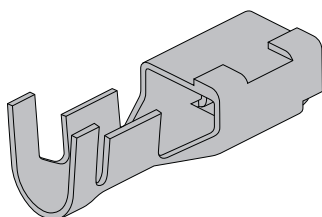
D-5000 α Series Contact• D-5 α Series silver-plated type

Wire Range		Outside Diameter of Insulation mm	Wire Range Mark	Contacts			Applicable tools			
AWG	mm ²			Receptacle Contact		Tab Contact	Hand Tools	Electric Hydraulic Tool \times 5	Dice \times 6	Tool numbers
				Strip form	Loose Piece	Loose Piece				
20	0.50	1.8-2.83	SS	1318985-6	1318986-6	—	91596-1	—	—	1366757-2 1528106-2
16	1.25	2.35-3.23								
16	1.25	3-3.80	S	179955-6	316040-6	917804-6	234170-1	2155369-1	2155822-1	1366659-2 1426229-2 \times 1
14	2.20									
12	3.50	4-5.2	M	179956-6	316041-6	917805-6	234171-1	2155369-1	2155503-1	1366660-2 \times 2 2151086-2 \times 3
10	5.50									
8	8.00	4.9-7.8	L	1318696-6	1318697-6	1747443-6	1366044-1	2155502-1	1366658-3 1426325-2 \times 4	

Note: The model with its name including “-6” has a silver plating of 2.54 μ m in thickness.

For details, please contact the purchase agent or sales department.

Please contact the sales department for mini application tools.

Strip Form contacts are used with Mini-applicators (bench machine) and Loose-Piece contacts are with hand tools.

\times 1 Applicable contact:179955-□

\times 2 Applicable contact:179956-□ 917803-□ 84695-□

\times 3 Applicable contact:179956-□ 917803-□

\times 4 Applicable contact:1318696-□

\times 5 See P. 107

If you have any questions, please contact the AT tooling sales department.

\times 6 Used together with the electric hydraulic tool 2155369-1

The Receptacle contacts can be used for all receptacle housings.

NOTE: all products are RoHS compliant On selection.

D-5200Mα Double-row High Current/Voltage Modular Type

Type Chart

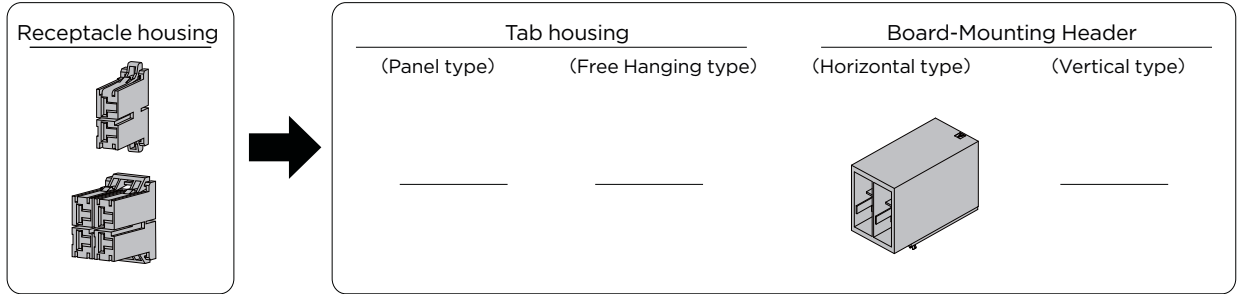

Pos	Color	Key	Receptacle housing	Tab housing		Plating	Board-Mounting Header	
				Panel type	Free Hanging type		Horizontal type	Vertical type
2	Black	X	1-179958-2	—	—	—	—	—
	Black	Y	2-179958-2	—	—	—	—	—
4	Black	XX	1-917807-2	—	—	Silver	1-1318983-6	—
	Black	YY	2-917807-2	—	—	Silver	2-1318983-6	—
	Black	XY	3-917807-2	—	—	Silver	3-1318983-6	—

Note: Receptacle housing 2-pole D-5200S and 4-pole D-5200M are the same product
However, contact used is D-5a (silver plating • type)

Relative Product Information

Applicable contact...P.90
Performance & Specifications...P.79

Mated Dimension

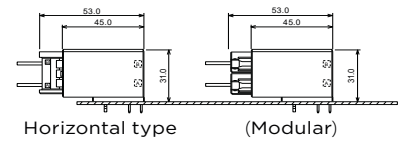

External Dimensions

Receptacle Housing

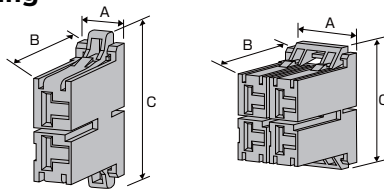

Pos	Key	Plating	Color	Part Number	Dimensions		
					A	B	C
2	X	—	Black	1-179958-2	9.8	29.0	23.8
	Y	—	Black	2-179958-2			
4	XX	—	Black	1-917807-2	20.0	29.0	33.4
	YY	—	Black	2-917807-2			
	XY	—	Black	3-917807-2			

Board-Mounting Header

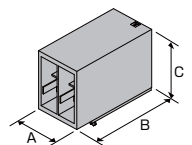

Pos	Key	Plating	Color	Part Number	Dimensions		
					A	B	C
4	XX	Silver	Black	1-1318983-6	22.6	45.0	30.9
	YY	Silver	Black	2-1318983-6			
	XY	Silver	Black	3-1318983-6			

NOTE: all products are RoHS compliant On selection.

DZ-5200

Useful for enabling cableless control board. High-current board to board connectors with 30A per contact.

- Equipped with retention leg to protect board from load
- Space allocated to prevent twisting the contact
- Circuit numbers are easy to identify even for board connectors
- Keying function included for flexibility when using multiple units
- Soldering without masking

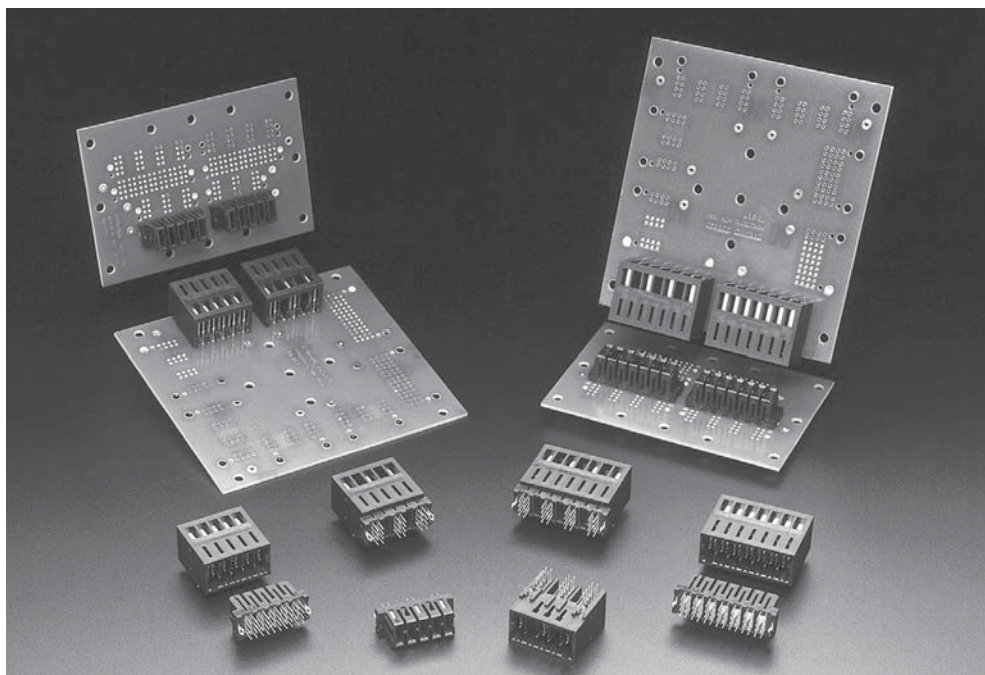

Performance Specifications

Item	Pitch	200 mils/400 mils 5.08mm/10.16mm
Rated Voltage		5.08mm Pitch:250V AC(rms)/DC 10.16mm Pitch:600V AC(rms)/DC
Rated Current		5.08mm Pitch:20A 10.16mmPitch:30A
Contact resistance		2mΩ Max
Withstanding Voltage		5.08mm Pitch:2,200V AC 1 min 10.16mm Pitch:4,000V AC 1 min
Temperature		-55-+105°C
Product Specifications		108-78186

Materials and Plating

Category	Materials	Plating
Receptacle Contact	Phosphor bronze Copper alloys	Gold Plating with Nickel under-plated
Tab Contact	Phosphor bronze Copper alloys	Tin, Gold Plating with Nickel under-plated
Housing	UL9 4V-0, thermoplastic PBT with glass fiber	

DZ-5200

Type Chart

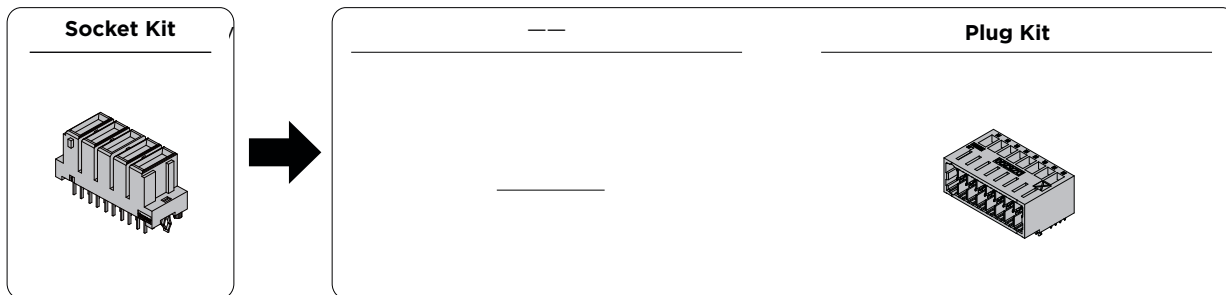

Pos	Color	Key	Socket Kit	Plating	---	Plug Kit
3	Black	—	5-1747147-3	Gold	---	5-1747145-3
4	Black	—	5-1747147-4	Gold	---	5-1747145-4
5	Black	—	1-1747147-5	Gold	---	1-1747145-5
7	Black	—	1-1747147-7	Gold	---	1-1747145-7

External Dimensions

Socket Kit

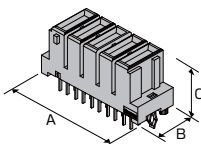

Pos	Key	Plating	Color	Part Number	Dimensions		
					A	B	C
3	—	Gold	Black	5-1747147-3	30.8	11.5	14.0
4	—	Gold	Black	5-1747147-4	40.9	11.5	14.0
5	—	Gold	Black	1-1747147-5	30.8	11.5	14.0
7	—	Gold	Black	1-1747147-7	40.9	11.5	14.0

Plug Kit

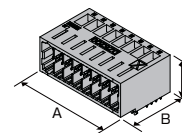

Pos	Key	Plating	Color	Part Number	Dimensions		
					A	B	C
3	—	Gold	Black	5-1747145-3	28.8	27.0	17.5
4	—	Gold	Black	5-1747145-4	39.0	27.0	17.5
5	—	Gold	Black	1-1747145-5	28.8	27.0	17.5
7	—	Gold	Black	1-1747145-7	39.0	27.0	17.5

NOTE: all products are RoHS compliant On selection.



Multi-Frame connector (MF Series)

The Multi-Frame connector is formed by accommodating the modular housing of the Dynamic connector in a resin frame, which could enable plugged and unplugged together. The modular housing of the existing D-2800, 3800, 4800 or 5800 series can be accommodated by the frame freely.

In addition, it is locked by an independently-developed locking mechanism automatically when plug, and can be unplugged easily with fingertips. The burden on the operator is reduced.

With this frame, a lot of work in assembly and maintenance can be saved, and incorrect operations such as incorrect wiring, etc. can be avoided.

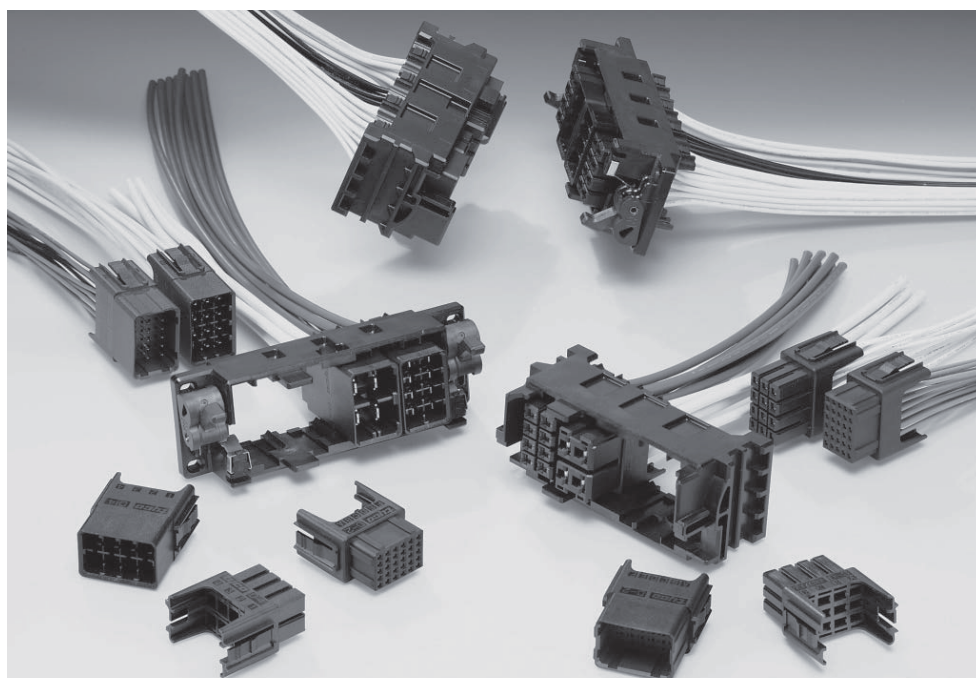

Main Performance

Item \ Series	D-2800	D-3800	D-4800	D-5800
Rated Voltage	AC/DC 250V	AC/DC 600V	AC/DC 600V	AC/DC 630V
Rated Current	5A	15A	25A	40A
	When an AWG#18 wire is used	When an AWG#16 wire is used	When an AWG#12 wire is used	When an AWG#8 wire is used
Contact resistance	Maximum: 10mΩ			Maximum: 2mΩ
Withstanding Voltage	1,500VAC(1 min)		2,500VAC(1 min)	3,000VAC(1 min)
Operating Temperature	-55~+105°C			
Product Specifications	108-78284	108-78285	108-78388	108-78389
Applications Specifications	114-5258	114-5148	114-5369	114-5206

Materials and Plating

Category	Materials	Plating
Receptacle Contact Tab housing	Phosphor bronze or copper alloy	Gold Plating with Nickel under-plated
Housing	UL94V-0, reinforced thermoplastic with glass fiber	

Contact

The D-2, D-3, D-4 and D-5 contacts of the Dynamic series can be directly used. (The existing tools can also be used as special tools and application tools)

See P. 29 for the D-2 terminal. See P. 74 for the D-4 terminal.

See P. 39 for the D-3 terminal. See P. 81 for the D-5 terminal.

Multi-Frame Connector

Product Features

- The modular structure can accommodate Dynamic series housings
- Panel mount
- Quick locking
- Easy unlocking by pressing the latches
- A key for preventing mis-plugging
- Easy operation

Applications

- Semiconductor and liquid crystal production equipment
- Large control equipment and machine tools
- Other

Product Specifications

Product standard number 108-78644

Performance Specification

Item	STD.
Frame Lock Strength	Pull force: Minimum: 15kgf
Durability	Maximum: 50 cycles

Mated Dimension

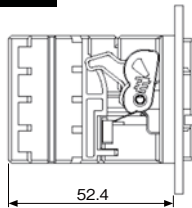

External Dimensions

■ Cable Side Frame

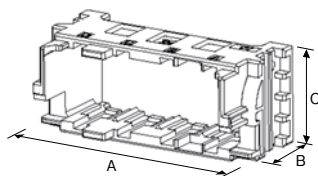

Key	Part Number	Dimensions(mm)		
		A	B	C
Z	2069524-4	97.1	45.1	40.4
Y	2069524-3			
X	2069524-2			
W	2069524-1			

■ Panel Side Frame

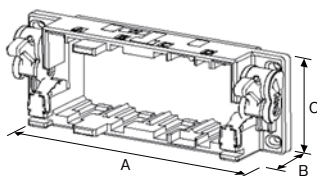

Key	Part Number	Dimensions(mm)		
		A	B	C
Z	2069526-4	120.0	34.3	40.4
Y	2069526-3			
X	2069526-2			
W	2069526-1			

Dynamic Multi-Frame (MF) Module

Type Chart

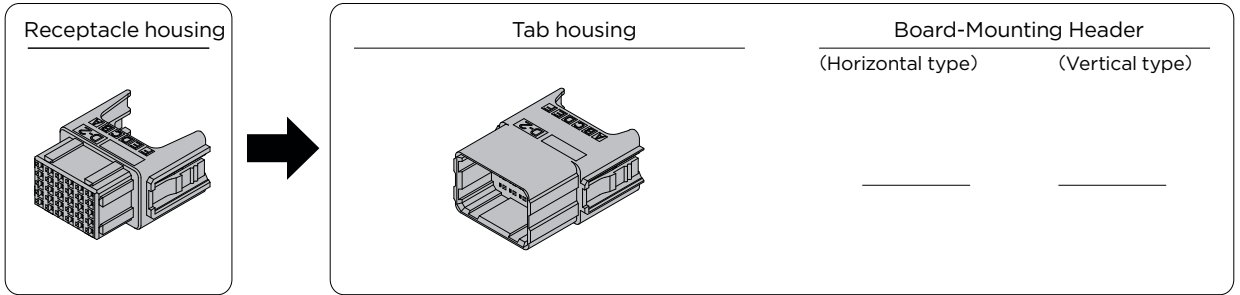

Pos	Color	Key	Receptacle housing	Tab housing	Plating	Board-Mounting Header	
						Horizontal type	Vertical type
30	Black	—	1747365-1	1747366-1	—	—	—
12	Black	—	1747363-1	1747364-1	—	—	—
8	Black	—	1871416-1	1871417-1	—	—	—
4	Black	—	1871418-1	1871419-1	—	—	—

D-2800 Pitch: 3.75mm

External Dimensions

■ Receptacle Housing

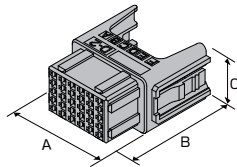

Pos	Key	Color	Part Number	Dimensions		
				A	B	C
30	—	Black	1747365-1	30.3	37.6	19.5

■ Tab Housing

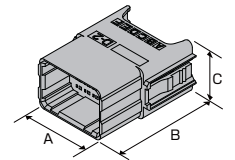

Pos	Key	Color	Part Number	Dimensions		
				A	B	C
30	—	Black	1747366-1	30.3	40.0	19.5

NOTE: all products are RoHS compliant On selection.

Dynamic Multi-Frame (MF) Module

D-3800 pitch: 6.5mm

External Dimensions

■ Receptacle Housing

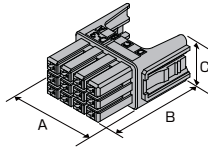

Pos	Key	Color	Part Number	Dimensions		
				A	B	C
12	—	Black	1747363-1	30.3	41.4	19.5

■ Tab Housing

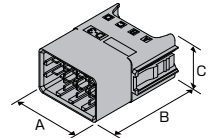

Pos	Key	Color	Part Number	Dimensions		
				A	B	C
12	—	Black	1747364-1	30.3	40.0	19.5

D-4800 pitch: 6.35mm

External Dimensions

■ Receptacle Housing

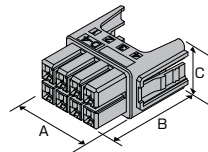

Pos	Key	Color	Part Number	Dimensions		
				A	B	C
8	—	Black	1871416-1	30.3	38.6	19.5

■ Tab Housing

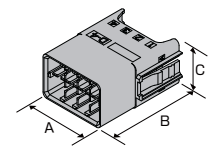

Pos	Key	Color	Part Number	Dimensions		
				A	B	C
8	—	Black	1871417-1	30.3	40.0	19.5

D-5800 pitch: 12.0mm

External Dimensions

■ Receptacle Housing

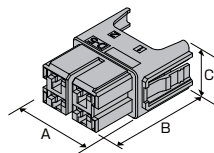

Pos	Key	Color	Part Number	Dimensions		
				A	B	C
4	—	Black	1871418-1	30.3	41.4	19.5

■ Tab Housing

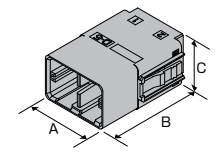

Pos	Key	Color	Part Number	Dimensions		
				A	B	C
4	—	Black	1871419-1	30.3	44.1	19.5

NOTE: all products are RoHS compliant On selection.

D-7000 Series

Series introduction

Dynamic D7000 series includes the highest power rated connector that is max 65A (per contact, using max. wire size)

It is available in board to wire, wire to wire, wire to panel -some are finger safe (Reverse Mount Type) - and long pin types all providing stable electrical connections for semiconductor manufacturing machines, construction plant etc. The number of positions is the industry standard 4P, which will meet a wide range of application requirements.

The receptacle contact is the 'crown banct' type containing a tube shape spring, meaning high performance and operation feasibility.

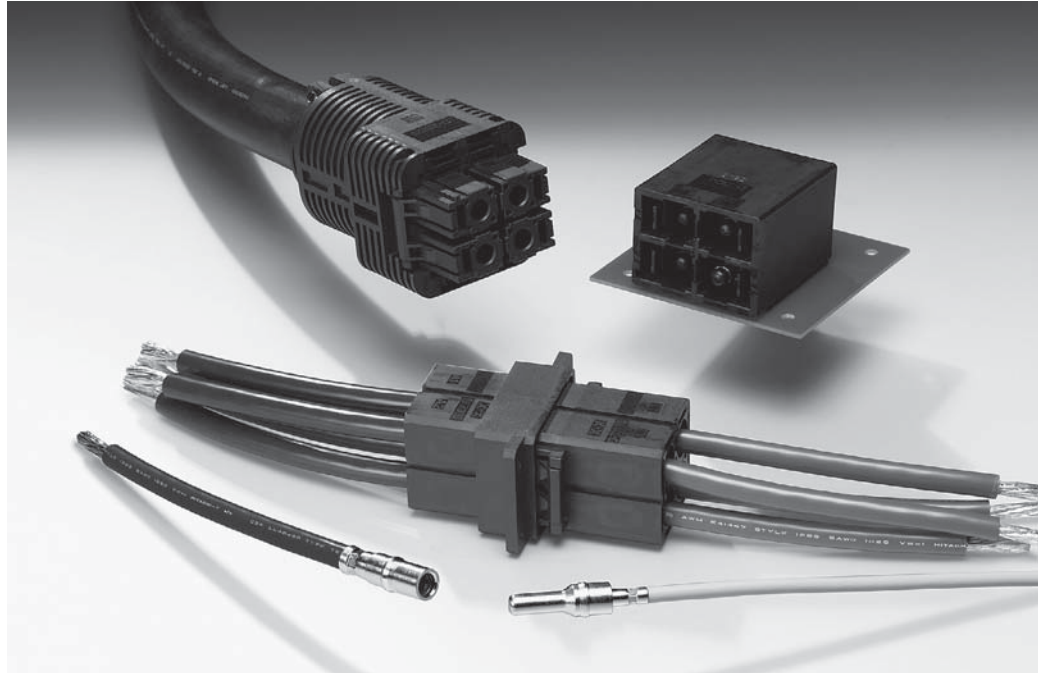

Product Features

1. Achieved High Current and High Reliability up to 65A

To accommodate the high current of 65A, we adopted, for the first time, a crown band with a multi-point contact mechanism in the receptacle contact. This contact is not only highly reliable, but disperses the heat generated when high current passes through the contact.

2. Sequential Connection

Sequential connection is compatible 2 types of pin contact are available, standard type and long type. This is ideal for applications when sequential connections from the crown pin are required.

3. Other

- Standard type and reverse type are available, offering a wide variety of mating options
- By using cable clamp type applicable to jacket cable, it can be used as an I/O connector

D-7000 Series Performance and Specifications

Performance

Item	
Pitch	16mm
Rated Current	Maximum: 65A
Rated Voltage	630V AC / DC
Dielectric Withstand Voltage	3000 VAC
Total resistance	Maximum: 2mff
Insertion strength:	Maximum (per positions): 49.0 N
Withdrawal strength	Minimum (per positions): 4.9N
Durability	20 cycles
Locking strength	Minimum: 196 N

Positions/Wire Size/Rated Current

Unit: A (Amps)

Position	Series	Wire Size(AWG)					
		18	14	12	10	8	6
4	BOARD-to wire	18	23	31	35	50	60
4	Wire-to-wire	-	-	31	35	55	65
4	(Wire-to-wire cable clamp type)	-	-	25	35	45	55

Product Specification

Product Specifications	108-78470
TEST REPORT	501-78004
Extraction tool application specification	408-78147
Applications Specifications	114-5452

When applicable, please be sure to order the operation manual. It can also be found in the online electronic specifications catalog.

Materials and Plating

Type	Item	Tab contact	Receptacle Contact (Crown-shaped Terminal)
Receptacle Contacts Tab Contact	Materials	Copper	Copper alloys
	Plating	Silver plating with Nickel under-plated	Gold plating with Nickel under-plated
Board Mount Header	Materials	Copper	
	Plating	Silver plating with Nickel under-plated	
Housing	Materials	UL94V-0, Thermoplastic PBT containing glass fiber	

Safety Standards

The safety specifications listed below are approved on specific part numbers. Please contact our Technical Support Centre to check whether the part numbers you use are approved or not. Keep in mind that there are instances where values differ from those given by Tyco Electronics Specifications.

STD.	Series	D-7100Series			D-7300Series																																																																		
		Rated Voltage	Rated Current	Temperature Range	Rated Voltage	Rated Current	Temperature Range																																																																
Product Specifications 108-5453		630V AC/DC	(As shown above)	-55°C --+105°C	630V AC/DC	(As shown above)	-55°C --+105°C																																																																
UL File No.E28476 (Recognized Component)		600V AC	Based on the requirements of Application	Uses AWG6 wires Allowable maximum 6A	600V AC	Based on the requirements of Application	Based on the requirements of Application																																																																
TOV License No. R50252537 IP protection Socket: IP-10 Plug: IP-00 Overvoltage type (II) 50 cycles of repeated plugging and unplugging		630V AC/DC	<table border="1"> <thead> <tr> <th colspan="4">4-No of Pos.</th> </tr> <tr> <th>AWG</th> <th>WTW</th> <th>WIRE-TO-BOARD</th> <th>Spring Type</th> </tr> </thead> <tbody> <tr> <td>16</td> <td>18</td> <td>-</td> <td>-</td> </tr> <tr> <td>14</td> <td>23</td> <td>-</td> <td>-</td> </tr> <tr> <td>12</td> <td>31</td> <td>31</td> <td>25</td> </tr> <tr> <td>10</td> <td>35</td> <td>35</td> <td>35</td> </tr> <tr> <td>8</td> <td>50</td> <td>55</td> <td>45</td> </tr> <tr> <td>6</td> <td>60</td> <td>65</td> <td>55</td> </tr> </tbody> </table>	4-No of Pos.				AWG	WTW	WIRE-TO-BOARD	Spring Type	16	18	-	-	14	23	-	-	12	31	31	25	10	35	35	35	8	50	55	45	6	60	65	55	-55°C --+105°C	630V AC/DC	<table border="1"> <thead> <tr> <th colspan="4">4-No of Pos.</th> </tr> <tr> <th>AWG</th> <th>WTW</th> <th>WIRE-TO-BOARD</th> <th>Spring Type</th> </tr> </thead> <tbody> <tr> <td>16</td> <td>18</td> <td>-</td> <td>-</td> </tr> <tr> <td>14</td> <td>23</td> <td>-</td> <td>-</td> </tr> <tr> <td>12</td> <td>31</td> <td>31</td> <td>25</td> </tr> <tr> <td>10</td> <td>35</td> <td>35</td> <td>35</td> </tr> <tr> <td>8</td> <td>50</td> <td>55</td> <td>45</td> </tr> <tr> <td>6</td> <td>60</td> <td>65</td> <td>55</td> </tr> </tbody> </table>	4-No of Pos.				AWG	WTW	WIRE-TO-BOARD	Spring Type	16	18	-	-	14	23	-	-	12	31	31	25	10	35	35	35	8	50	55	45	6	60	65	55	-55°C --+105°C
4-No of Pos.																																																																							
AWG	WTW	WIRE-TO-BOARD	Spring Type																																																																				
16	18	-	-																																																																				
14	23	-	-																																																																				
12	31	31	25																																																																				
10	35	35	35																																																																				
8	50	55	45																																																																				
6	60	65	55																																																																				
4-No of Pos.																																																																							
AWG	WTW	WIRE-TO-BOARD	Spring Type																																																																				
16	18	-	-																																																																				
14	23	-	-																																																																				
12	31	31	25																																																																				
10	35	35	35																																																																				
8	50	55	45																																																																				
6	60	65	55																																																																				

D-7000 Series Contact

■ Crimped Types

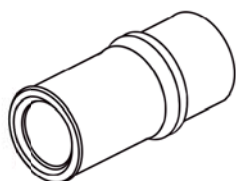

Receptacle Contact
(Receptacle housing usage)

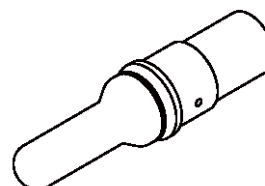

Tab contact
(Tab housing usage)

• Gold-plated Receptacle contact, Silver plated Tab contact

Wire Range		Outside Diameter of Insulation mm	Diameter of Contacts		Applicable tools	
AWG	mm ²		Receptacle Contact	Tab contact		
16-14	1.6-2.6	10	1871132-4	—	409777-1※1	
12-10	2.7-6.6	10	1871132-3	STD.	1871131-3	2155816-1 ※3
				LONG	1-1871131-3	2155815-1 ※4
8	6.7-10.5	10	1871132-2	STD.	1871131-2	2155369-1 ※2
				LONG	1-1871131-2	
6	10.6-16.7	10	1871132-1	STD.	1871131-1	2155810-1 ※6
				LONG	1-1871131-1	

For details, please contact the purchase agent or sales department.

※1 Hand tool (W-shaped crimp)

※2 Electric hydraulic tool See P. 107.
If you have any questions, please contact the sales department.

※3 Mold (2155369-1 used together with the electric hydraulic tool / applicable wire: AWG#12; crimp shape: hexagon)

※4 Mold (2155369-1 used together with the electric hydraulic tool / applicable wire: AWG#10; crimp shape: hexagon)

※5 Mold (2155369-1 used together with the electric hydraulic tool / applicable wire: AWG#8; crimp shape: hexagon)

※6 Mold (2155369-1 used together with the electric hydraulic tool / applicable wire: AWG#6; crimp shape: hexagon)

The receptacle contact can be used in all receptacle housings, the tab contact can be used in all tab housings

NOTE: all products are RoHS compliant On selection.

D-7100

Type Chart

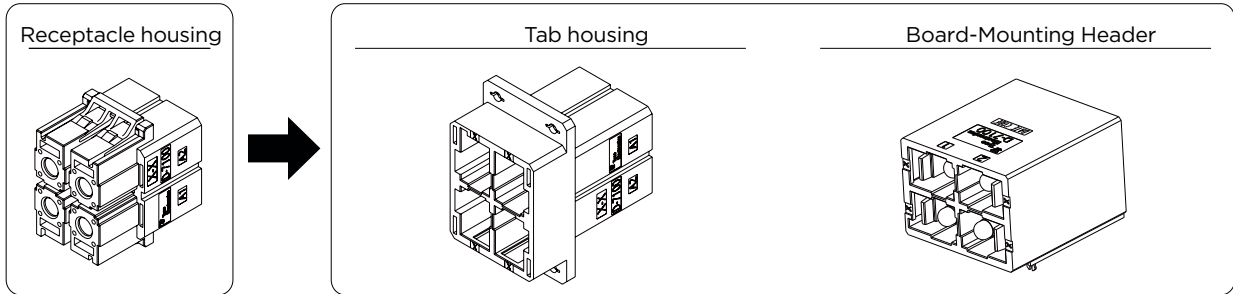

Pos	Color	Receptacle housing	Tab housing	Plating	Board-Mounting Header
4	Black	2134055-1	2134057-1	Silver	1981823-1

Relative Product Information

Applicable contact...P.100

Performance & Specifications...P.99

External Dimensions

■ Receptacle Housing

4P Model: 2134055-1

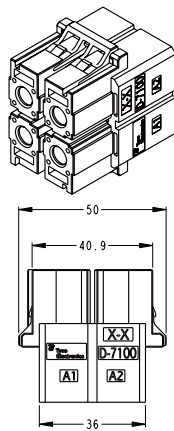

■ Tab Housing

Panel type

4P Model: 2134057-1

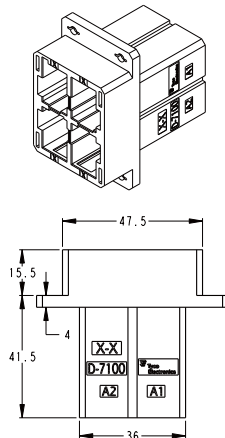

NOTE: all products are RoHS compliant On selection.

■ Board-Mounting Header

4P Model: 1981823-1

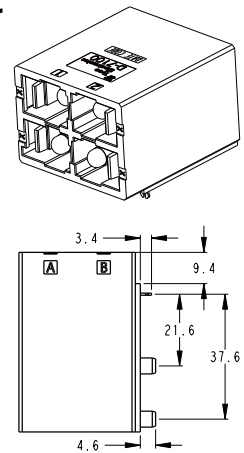

D-7300

Type Chart

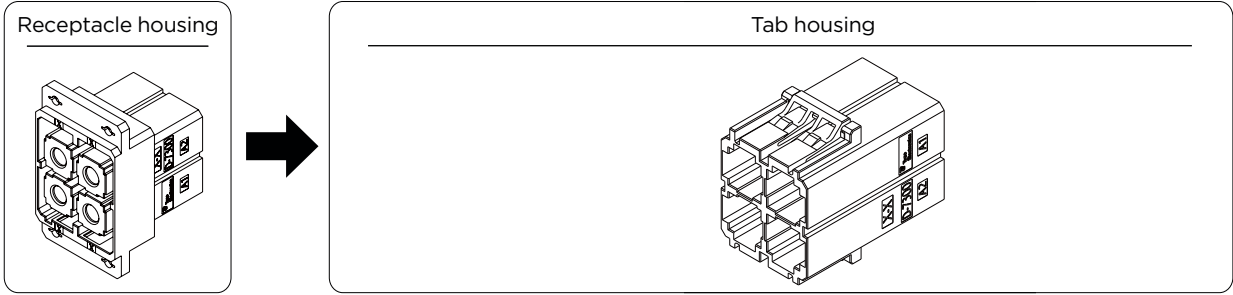

Pos	Color	Receptacle housing	Plating	Tab housing
4	Black	2134059-1	Silver	2134061-1

Relative Product Information

Applicable contact...P.100
 Performance & Specifications...P.99

External Dimensions

■ Receptacle Housing

4P Model: 2134059-1

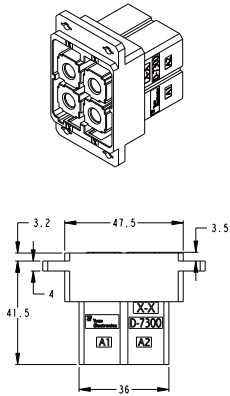

■ Tab Housing

Panel type
 4P Model: 2134061-1

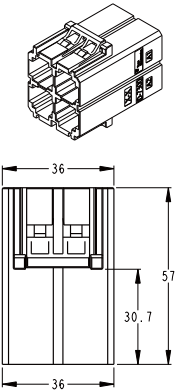

NOTE: all products are RoHS compliant On selection.



D-7100 Dyna-Clamp Kit

External Dimensions

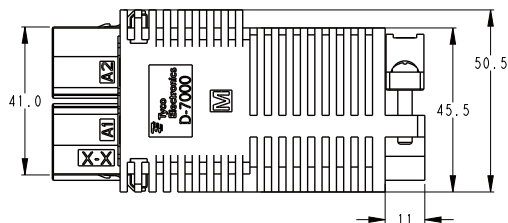

Pos	Color	Cable Size	Part Number
4	Black	S ø19 - 25	2-2069313-1
		M ø25 - 31	1-2069313-1

D-7300 Dyna-Clamp Kit

External Dimensions

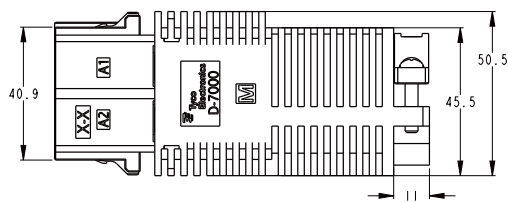

Pos	Color	Cable Size	Part Number
4	Black	S ø19 - 25	2-2069312-1
		M ø25 - 31	1-2069312-1

Relative Product Information

Applicable contact...P.100

Performance & Specifications...P.99

NOTE: all products are RoHS compliant On selection.

Multiple Enclosure Connector (ME Series)

Series introduction

Human machine interfaces (HMI) can be found on a variety of machines. They allow people to communicate with equipment to control, operate and program. The multiple enclosure connector was developed as a connector for I/O interfaces for HMI.

They have superior operability, are very safe, easy to use. Plus, they use Dynamic series contacts to give them very high reliability. There are two types in this series, metal and plastic, enclosures used according to the environment.

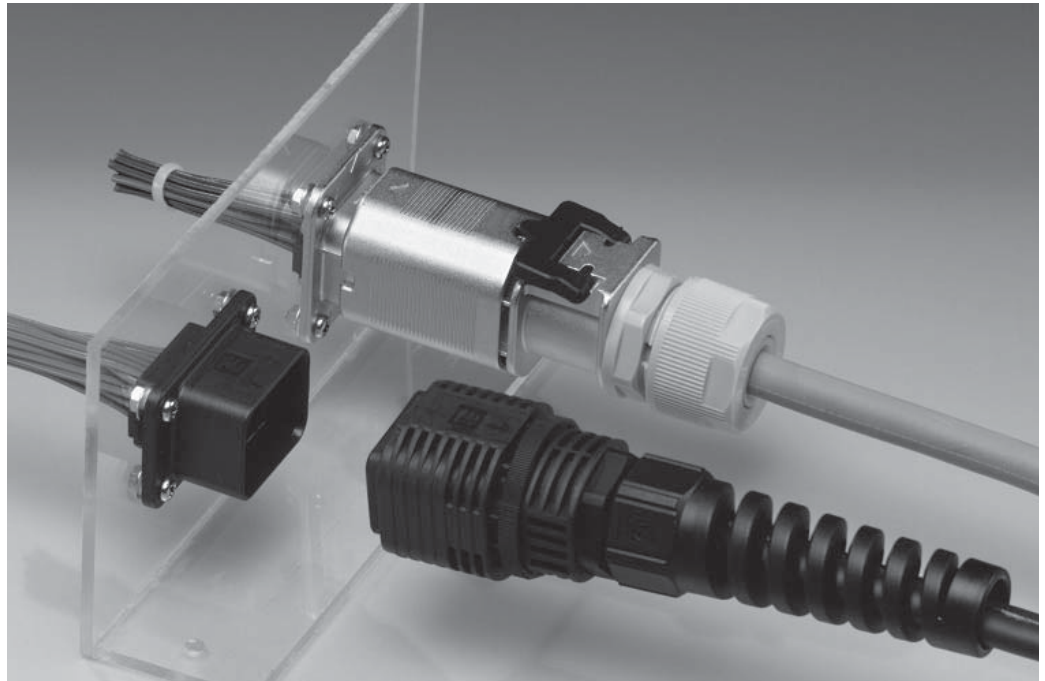

Product Features

1. Wire Sizes

The metal type fits wires with diameter from 10mm to 11mm, the plastic type from 5mm to 12mm.

2. Applicable Contacts

The highly reliable Dynamic D-1000 and D-3000 series terminals are used as contacts for I/O connectors for human machine interfaces (HMI). These can be crimped by using existing Dynamic crimping tools.

3. IP65 (plastic type), IP67 (metal type) i

The connectors have dust and water proofing for use in harsh conditions.

4. Safety Lock Mechanism

The lock mechanism uses the fast on/off lock concept which can be locked or released by just grabbing the connector. Plus, our proprietary double lock mechanism prevents vibration related disconnect accidents.

5. Two Types of Housing

The series includes two types of housing, a standard type and a reverse type for preventing exposure of live contacts.

6. Cable Clamp Interface

Cable clamps, which are commercially available and can be selected according to application and purpose, can be attached to cover the cable entering the connector.

7. Other Considerations

Audible & tactile locking design ensure the complete connection between receptacle and tab.

Multiple Enclosure Connector (ME Series)

Performance Specifications

Item	Standard
Rated Current	See the reference
Rated Voltage	125VACrms (for the part with a pitch of 2mm)
Dielectric Withstand Voltage	1,000V AC (1 min)
Operating temperature	-30°C -105°C (including the temperature rise caused by electrification)
Total resistance(low level)	Maximum (initial): 10mff
Insulation resistance	Minimum (initial): 1,000Mff
Insert Strength	Maximum (per position): 39.2N
Withdrawal Strength	Maximum (per position): 4.9N
Durability	50 cycles
Enclosure Lock Strength	Minimum: 98N

Product Specification

Product Standards	108-78417
Applications Specifications	114-5377
Manual	411-78287,78288(14+1P) 411-78262,78277(24P)

Plastic type

Product Standards	108-78566
Mounting Application Standard	114-5377
Manual	411-78293(32P)

Contact

Refer to D-1000 contact on P. 13 and D-3000 contact on P. 39

Positions/Wire Size/Rated Current

Contact Wire Size Position	Receptacle contacts and tab contact						
	AWG #18	AWG #20	AWG #22	AWG #24	AWG #26	AWG #28	AWG #30
24Pos	-	-	2	1.5	1	0.8	0.5
14+1Pos	3.5	2.7	2.5	2	1.5	1	0.8

Plastic type

Contact Wire Size Position	Receptacle contacts and tab contact				
	AWG #22	AWG #24	AWG #26	AWG #28	AWG #30
32Pos	1.5	1	0.8	0.5	0.5

Materials and Plating

Metal type

Parts Materials	Materials	Finish
Contact	Copper alloys	Gold plating over Nickel under-plated
housing	UL94V-0, thermoplastic polyamide	—
Connector Case	Zinc	Nickel-plated
Packing	Nitrile rubber	—
Shield Grip	Cold-rolled steel	Nickel plating over copper base

Plastic type

Description	Materials	Finish
Contact	Copper alloys	Gold plating over Nickel under-plated
Connector housing	UL94V-0, thermoplastic polyamide	—
Connector Case	UL94V-0, thermoplastic polyamide	—
for bottom	Nitrile rubber	—

Multiple Enclosure Connector (ME Series)

Type Chart

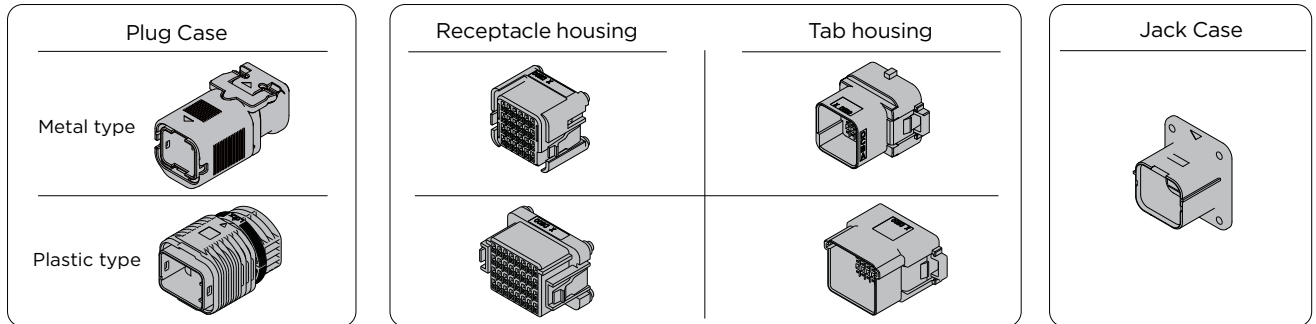

Type	Pos.	Plug Case	Polarity	Housing		Jack Case
				Receptacle (R) / Tab (T)		
Metal housing type	24	1939847-1	Standard	1939850-1(R)	1939839-1(T)	1939840-1
		1981560-1	Reverse	1981556-1(T)	1981551-1(R)	
Metal housing type	14+1	1939847-1	Standard	1981135-1(R)	1981133-1(T)	1939840-1
		1981560-1	Reverse	1981947-1(T)	1981945-1(R)	
Plastic housing type	32	1981919-1	Standard	1981921-1(R)	1981914-1(T)	1981913-1
			Reverse	2013393-1(T)	2013391-1(R)	

Shield clip P / N 1939851 -1 (plug case) tool: 1891820 -1 (411-78273)

Relative Product Information

Applicable contact... 24 position product: D-1000 S.M contacts see P. 13.
 14+1 position product: The D-1000 & D-3000 contacts see P. 13 and 39
 32 position product: D-1000 S.M contacts see P. 13

External Dimensions

■ Receptacle Housing

Standard Type (Plug Case)

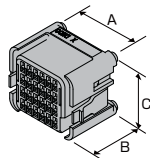

Pos	Key	Plating	Color	Part Number	Dimensions		
					A	B	C
24	—	—	Black	1939850-1	19.6	15.3	16.8
14+1	—	—	Black	1981135-1	22.0	22.8	16.8
32	—	—	Black	1981921-1	27.2	15.3	17.6

Reverse (Jack Case)

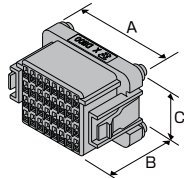

Pos	Key	Plating	Color	Part Number	Dimensions		
					A	B	C
24	—	—	Black	1981551-1	27.5	23.7	20.2
14+1	—	—	Black	1981945-1	27.5	23.7	20.2
32	—	—	Black	2013391-1	29.5	23.0	17.0

NOTE: all products are RoHS compliant On selection.

■ Tab Housing

Standard Type (Jack Case)

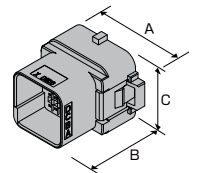

Pos	Key	Plating	Color	Part Number	Dimensions		
					A	B	C
24	—	—	Black	1939839-1	27.5	23.3	20.0
14+1	—	—	Black	1981133-1	27.3	27.5	20.2
32	—	—	Black	1981914-1	29.5	22.3	17.0

Reverse (Plug Case)

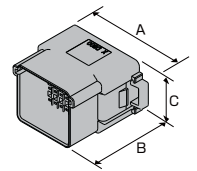

Pos	Key	Plating	Color	Part Number	Dimensions		
					A	B	C
24	—	—	Black	1981556-1	19.6	20.8	16.8
14+1	—	—	Black	1981947-1	22.8	28.2	16.8
32	—	—	Black	2013393-1	27.2	20.0	17.6

Applicable Tools

■ AMP - 3K/AMP - 5 K Tabletop Crimping Machine.

AMP - 3K/AMP - 5 K is a compact, low-cost desktop crimping machine. A DC motor linear scheme is used for low noise, and motor speed adjustment can be easily changed. It offers a wide range of crimping operations options with simple operation and a comfortable working environment.

- It can be equipped with other companies' application tools.
- The crimping height can be adjusted at 0.013 mm per step.
- It can be used with a power supply of AC100V/240V.
- Low noise and easy speed adjustment are achieved due to the DC motor drive.
- Multiple modes and optional parts are available depending on the operating environment.

Name		AMP-3K	AMP-5K
Part Number	Type Universal mount type	1725950-3	1725900-3
	AMP quick mount type	1-1725950-2	1-1725900-2
Stroke		30 mm	
Dimensions		The application tool is mounted on the safety cover closed side (no reel): 512mm (width) x415mm (depth) x510mm (height) The application tool is mounted on the safety cover closed end (no reel): 427mm (width) x523mm (depth) x510mm (height)	
Weight		About 70kg (main body of the crimping machine)	
Power supply		AC100-240V (310%) Single-phase 50 / 60Hz (6A)	
Cycle time		0.4 s (when the jog mode is terminated)	



■ SCM Stripper Crimping Machine (Tabletop Crimping Machine)

Stripper Crimping Machine with exchangeable Dies. With optimum processing of jacket cable ends, the operator selects among strip and crimp, strip only or crimp only with one touch.

Type	AMP-3K Specification 1596509-3	AMP-5K Specification 1596509-4
Applicable Wire	AWG 32-14 with the maximum skin outer diameter of 5.08mm (some AWG32-30 wires are inapplicable.) Please contact us for details.	
Jacket strip Dimensions	Min 29mm (or wire set if the peeling size is 29-45mm) The time is longer than usual.	
Strip Length	2.5-10mm	
Usable Applicators	Our company's 40mm stroke side feed application tool	
Noise level	< 82 dB	
Crimp ability	13,345N (1,360kgf) Can be crimped to the AWG14	22,226N(2,268kgf) Can be crimped to the AWG10 (or to AWG14, if it is an SCM)
Power supply	AC 100-240V single phase 50/60Hz	
Air pressure	0.49 - 0.59MPA (5 - 6kg/cm2)	
Machine weight	About 80 kg	

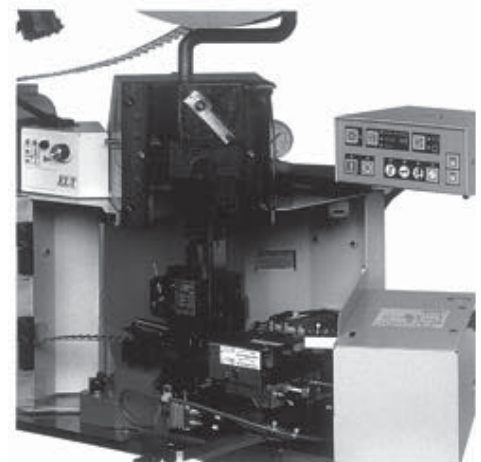

AMP-3K Specification SCM

Applicable Tools

■ TE REC-Li 250 M (charging hydraulic multi-function tool)

- The lithium-ion battery is the lightest in its class.
- High power due to dual Battery-electric & hydraulic pump use.

Product Specification Rated output 54 kN
 Crimp Range: 5.5 to 60mm² electric machine:
 14.4 V DC motor
 External dimensions 286 mm (length) x 285mm (H) x 75mm (width) Weight: 2.7 kg (6 lb) (60 mm 2 Dices, battery pack included)
 No. of times can be crimped: 270 times (60 mm 2crimp per hour),
 Manufacturer Part Number: 2155363 - □

■ TE REC-Li 250 M (charging hydraulic multi-function tool)

Product Specification Rated output 127kN
 Crimp Range: 14 to 250 mm² (copper wire bare pressure terminal and sleep)
 Electric motor: 14.4 V DC motor
 External dimensions 340mm (length) x 280mm (H) x 75mm (width)
 Weight: 4.2kg (250mm 2 Dices, battery pack included)
 No. of times can be crimped: 50 times (250mm 2crimp per hour),
 Manufacturer Part Number: 2155363 - □



■ Key Plug-equipped D-1000 Series

Part Number:1939588-1

■ Key Plug-equipped D-2000 Series

(Used to prevent misinsertion)
 Avoid mis-plugging when connectors with the same No of Pos. are used together.

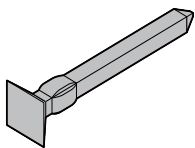

Part Number:641994-1

■ Key Plug-equipped D-3000 Series

(Used to prevent mis-plugging) Avoid mis-plugging when connectors with the same No of Pos. are used together.

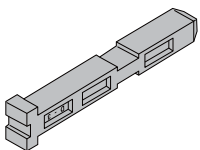

Part Number:175855-1

■ Receptacle Contact Cutting Tool D-1000 Series

Part Number: 919041-3
 Application Specification: 411-78047

■ Receptacle Contact Cutting Tool D-2000 Series

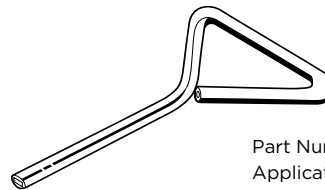

Part Number: 919041-2
 Application Specification: 411-78047

■ Receptacle Contact Cutting Tool Series D-3000 Series

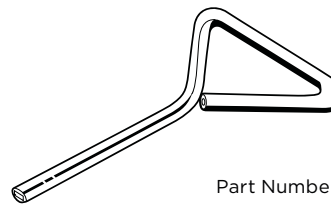

Part Number: 919041-1
 Application Specification: 411-78047

Applicable Tools

■ How to use the plug and cutting tool

※It should be noted that some of the products (D-2100 S/D-2100 D) to prevent mis-insertion, use keying mechanism from the beginning.

①Keying Plug inserted in one pole of the receptacle housing.

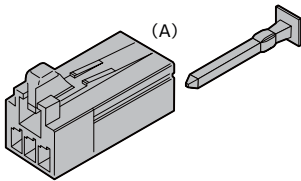

②Wrench off a tab in the corresponding position of mating Tab Header and empty that position. To wrench off the tab, insert Cutting Jig into its root and turn tool as shown.

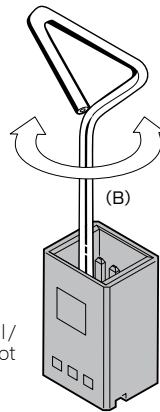

※*In tab Housing (Panel/freehanging type), 1 pole is not inserted and is left free.

■ How to use the plug and tool for the D-3000 Series

In addition, mis-insertion function keying has been installed from the beginning in some of the products (D-3100S/ D-3100M/ D-3200S/D-3200M)

①The keying plug is inserted into the receptacle housing

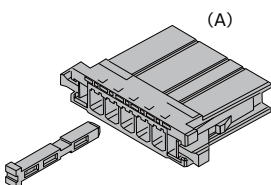

②Wrench off a tab in the corresponding position of mating Tab Header and empty that position. To wrench off the tab, insert Cutting Jig into its root and turn tool as shown

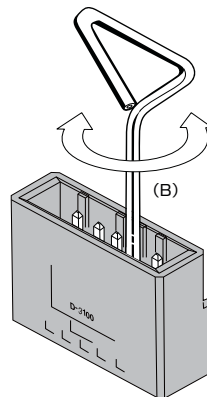

* In tab Housing (Panel/freehanging type), 1 pole is not inserted and is left free.

③When using these, it is impossible to mis-insert

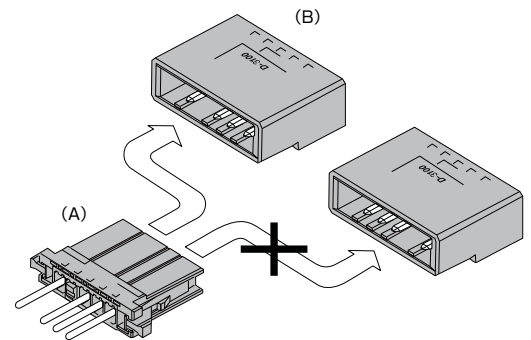

■ Hand tools PEW 12, D-1000, D-3000 and D-4000 series



- Crimping with a straight action feel
By manipulating the fulcrum of the handle, we have created a crimper that, while double action, is almost like straight action.
- Interchangeable dies
The dies are easy to change. This means a wide variety of terminals can be handled with the minimum number of tools.
- Improve work efficiency
Contact series, wire sizes and crimp heights printed on work surface of dies.
- Lower cost than existing specialized tools
The superior functionality you want, at a price you like.

Applicable Tools

■ **Hand Tools CERTI-CRIMP II, D-1000 Series Flip Locator, D-2000 Series, D-3000 Series, D-5000 Series**
Crimp part, as well as the machine, are highly reliable, Straight action method is introduced.



D-1000 series with Flip Locator

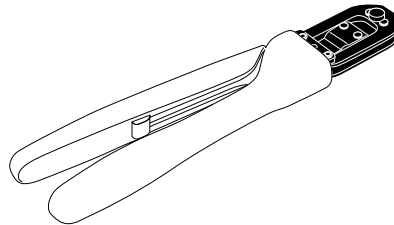

Part Number: See P. 29, 39, 81.

- Handles are completely covered in urethane to be easy to grip and gentle to workers, hands. Wire ranges and crimping height control values are printed on the crimping head for easy confirmation while working. Also, the ratchet in the handle keeps crimping quality very consistent. Hand crimping tool with wire stripper has four variations, while the previous model had only three variations. We recommend periodic maintenance when using hand crimping tools to keep crimping quality consistent.

■ Hand Tool D-4000 Series

Crimper uses the reliable straight action method

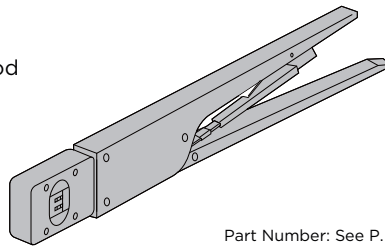

Part Number: See P. 74

■ Hand Tool D-5000 Series

As with machine use, the reliable straight action method is used.

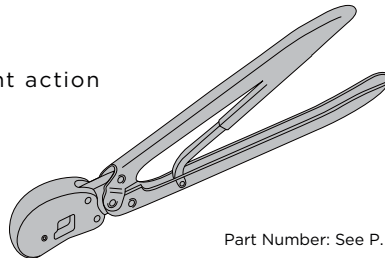

Part Number: See P. 81

■ Extraction Tool for D-1000 Series

Used to pull D-1000 from the housing

Part Number:1891526-1
Manual: 411-78241

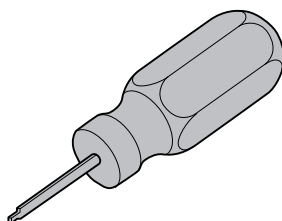

■ Extraction Tool for D-2000 Sseries

Used to pull D-2000 contacts from the housing

Part Number:1276716-1

Applicable Tools

■ Extraction Tool for D-3000 Series

wiring type tool for pulling the contact from the housing

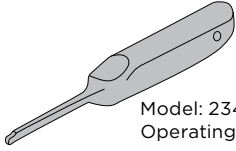

Model: 234168-1
Operating Manual: 411-5726

Using the extractor

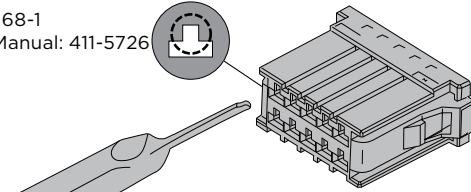

① Extractor tool is inserted into the small, upper part of the convex hole in the housing as shown in the diagram (please hold the tool the right way up)

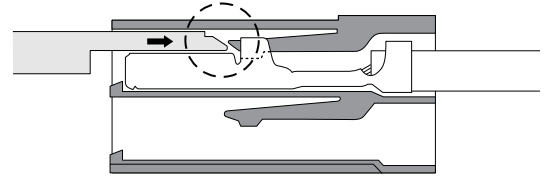

② The tip of the tool lifts the housing lance and frees the contact

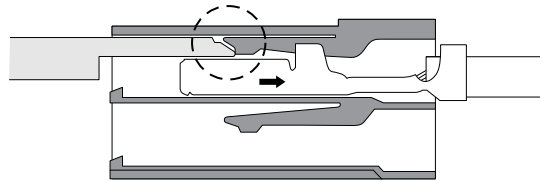

③ Contact can be withdrawn

* Take care not to insert into the Contact Section. If you have inserted by error, replace the damaged contact with a new one before proceeding.

■ Extraction Tool for D-5000 Series

Wiring type tool for pulling the contact from the tab / receptacle housing (between D-3 and D-5 the lance part is inverted, so please take care on insertion) In D-5 contact only, pulling can be achieved with a small O-driver or awl. Please note that the contact cannot be inserted into the contact section. If you have inserted by mistake, please replace and use a new one.

Part number: 409158-1
Manual: 411-5774

Using the Extraction Tool

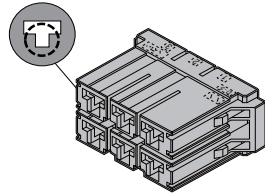
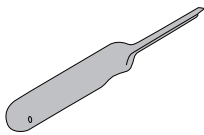

① The pulling tool should be inserted into the narrow part of bottom, with convex hole in the housing as shown in the diagram.

If using the D-5 Extraction Tool

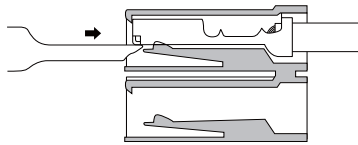

② The tip of the tool lifts the housing lance and frees the contact

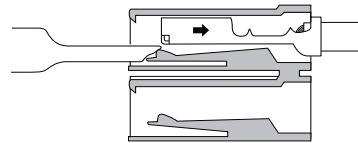

③ Contact can be withdraw

If using a small O-driver or awl

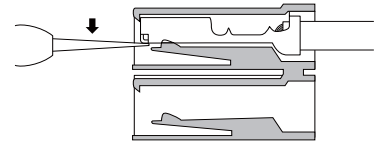

② The tip pushes down the lance part and frees the contact

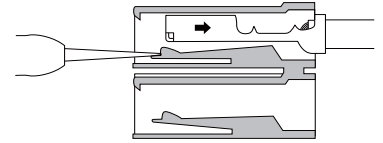

③ Contact can be withdraw

■ Unplugging tool D-7000 series

Part Number: 2040080-1
Operation Manual: 408-78147



Please be sure that it is not inserted into the terminal position. If it is inserted incorrectly, replace the terminal with a new one.

■ Crimping Oil Model number

Part Number: 939691-1
For easing the friction between tool and contact during crimping



■ Sequence clip

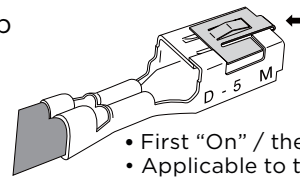

- First "On" / then "Off"
- Applicable to the D-5 terminal only

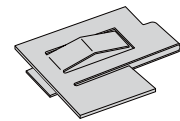

Part Number: 179993-1

Accessories

■ L-bracket D3000

Used to secure free-hanging type tab housings onto panels. Two styles, large and small, are available, the former for large-sizes housings and the latter for small housings. Applicable housings are specified in the table of housings 5900121-2 (S), 5900121-4(L)

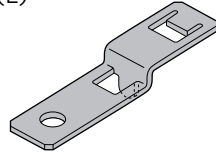

Part Number:5900121-2 (S)

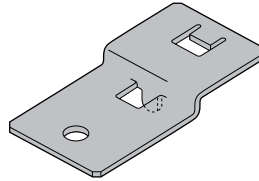

Part Number:5900121-4(L)

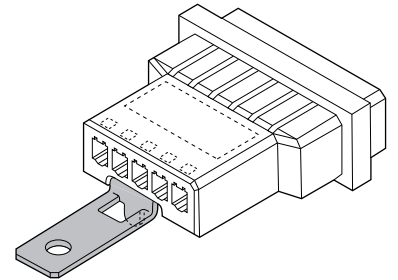

■ Push rivets

Used to secure panel-type tab housings onto panels (Use as a handy mounting hardware. Cannot be used with larger sized housings or those that are frequently inserted and withdrawn).

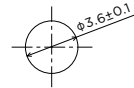
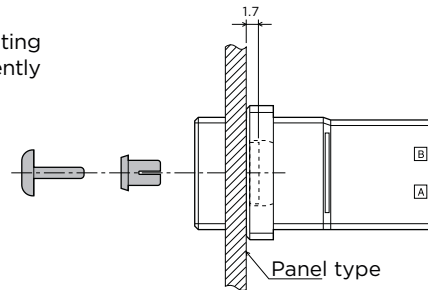
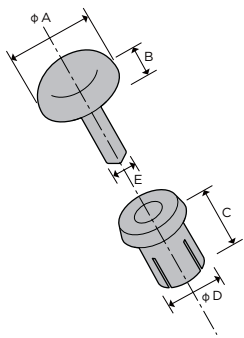

Panel Hole Machining recommended

Part Number	Panel Thickness	Dimensions					Insertion Strength	Retention Force
		A	B	C	D	E		
900128-1	0.3-1.3	6.4	1.6	4.5	3.5	1.95	19.6N-29.4N	127.4N Min.*
900128-2	1.3-2.3	6.4	1.6	5.5	3.5	1.95	19.6N-29.4N	127.4N Min.*

*when using 2

Panel Mounting Screws D-2000, D-3000

Part Number	Dimensions		
	A	B	C
900167-1	9.0	10.3	M3

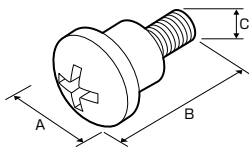

Panel Mounting Hex Screws D-2000

Part Number	Dimensions		
	A	B	C
1376059-1	5.5	12.3	M3

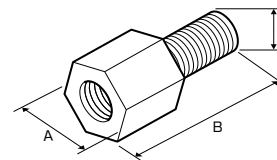

Cable Glands

Plastic Gland



Material: PA
 Press seal material: PA
 Seal material: EPDM
 Temperature range: -40°C-+100°C
 Protection: IP68

Metr.	Dimension D		SW	Type	Part Number	Color of Housing
	Minimum	Maximum				
M20*1.5	5	9	24	HSK-M20B-H	T3209201112-001	Black
	6	12	24	HSK-M20B	T3209201122-001	Black
	8	14	27	HSK-M20B-D	T3209201102-001	Black
	5	9	24	HSK-M20G-H	T3209201212-001	Grey
	6	12	24	HSK-M20G	T3209201222-001	Grey
	8	14	27	HSK-M20G-D	T3209201202-001	Grey

Metal Gland



Material: Nickel plated brass
 Press seal material: PA
 Seal material: NBR
 Temperature range: -40°C-+100°C
 Protection: IP68

Metr.	Dimension D		SW	Type	Part Number
	Minimum	Maximum			
M20*1.5	5	9	22	DLX-20-MT	T3609200112-000
	6	12	22	DLX-20-M	T3609200102-000
	10	14	24	DLX-20-MB	T3609200122-000

EMC cable glands



Material: Nickel plated brass
 Press Seal Material: PA
 Temperature range: -40°C-+100°C
 Protection: IP68

Metr.	Dimension D		SW	Type	Part Number
	Minimum	Maximum			
M20*1.5	5	9	24	DLX-20-MTC	T3707200113-000
	7	12	22	DLX-20-MC	T3706200103-000

Part basic number index

Contact and connectors

Part Number	Page	Part Number	Page	Part Number	Page	Part Number	Page	Part Number	Page
84696	81	316080	50,52	1376135	30	1903125	13	2347005	62
91576	29	316081	50,52	1376136	31,32	1903126	13	2348454	19,21
175194	39	316130	47,49	1376137	31,32	1903328	75,76	2348455	19,21
175195	39	316131	47,49	1717412	44,45	1903601	44,45	2348456	18
175196	39	316132	47,49	1747145	93	1939638	15,17	2349815	63
175216	39	316133	47,49	1747147	93	1939760	14	2349825	64
175217	39	316516	58,59	1747277	75,76	1939761	14	2349849	64
175218	39	316517	58,59	1747415	74	1939840	106		
175284	39	353079	82,83	1747416	74	1939847	106		
175285	39	353080	82,83	1747418	74	1981458	84,85,88,89		
175286	39	353081	82,83,88,89	1747419	74	1981560	106		
175287	39	353082	82,83,88,89	1747443	90	1981690	81		
175288	39	353715	39	1747498	74	1981691	81		
175289	39	353716	39	1747499	74	1981823	101		
175365	58,59	353717	39	1747500	74	1981913	106		
177555	58,59	353718	39	1747501	74	1981919	106		
177662	43	917251	57	1747994	31,32	2013325	25		
177665	43	917337	47,49	1827538	34	2013593	81		
178136	47,49	917338	47,49	1827569	13	2013594	81		
178137	46	917484	39	1827570	13	2013891	21		
178138	47,49	917485	39	1827571	13	2013892	21		
178139	50,52	917511	39	1827572	13	2040015	74		
178140	50,52,53,54	917512	39	1827581	22,23	2040016	74		
178141	46	917541	82,83	1827583	22,23	2040516	15,17		
178216	57	917542	82,83	1827586	13	2040586	74		
178293	40,42	917657	50,52	1827587	13	2040587	74		
178294	40,42	917658	50,52	1827588	13	2069312	103		
178295	40,42	917802	81	1827589	13	2069313	103		
178296	40,42	917803	81	1827872	15,17	2174021	81		
178297	40,42	917804	81,90	1827873	15,17	2174022	81		
178298	40,42	917805	81,90	1827875	19,21	2229794	63		
178303	44,45	1123309	84,85,88,89	1827876	19,21	2229800	63		
178305	44,45	1123624	56	1871131	100	2229803	63		
178306	44,45	1123829	84,85	1871132	100	2229806	63		
178307	44,45	1318105	29	1871303	13	2271454	63		
178308	44,45	1318106	29	1871304	13	2271457	63		
178313	40,42	1318107	29	1871315	15,17	2271887	15,17		
178314	40,42	1318108	29	1871468	18	2271888	15,17		
178315	40,42	1318109	29	1871731	13	2287721	74		
178316	40,42	1318110	29	1871743	13	2287732	74		
178317	40,42	1318111	29	1871744	13	2288019	74		
178318	40,42	1318112	29	1871745	13	2288020	74		
178323	44,45	1318123	30	1871935	25	2289080	63		
178325	44,45	1318124	31,32	1871940	25	2298107	39		
178326	44,45	1318125	31,32	1903111	13	2299004	55		
178327	44,45	1318126	31,32	1903112	13	2299005	43		
178328	44,45	1318127	31,32	1903113	13	2311162	39		
179188	43	1318579	33	1903114	13	2326092	84,85		
179276	47,49	1318696	81,90	1903115	13	2329463	15,17		
179277	47,49	1318697	81,90	1903116	13	2331743	63		
179955	81,90	1318983	91	1903117	13	2336488	67		
179956	81,90	1318985	81,90	1903118	13	2336490	67		
179959	82,83	1318986	81,90	1903120	13	2336491	67		
179960	82,83	1376009	31,32	1903121	13	2336494	67		
316040	81,90	1376020	31,32	1903122	13	2341421	15,17		
316041	81,90	1376133	58,59	1903124	13	2347004	62		



Part basic number index

Tools and Equipment

Part Number	Page	Part Number	Page
91558	36,39	2151240	29
91559	36,39	2155369	81,90,100
91560	36,39	2155502	81
91561	36,39	2155503	81
91565	36,39	2155810	100
91596	79,81,90	2155814	100
234170	79,81,90	2155815	100
234171	79,81,90	2155816	100
409777	100	2155822	81,90
1366044	79,81,90	2266273	81
1366658	90	2266274	81
1366659	90	2266289	74
1366660	90	2836130	39
1366757	90		
1426229	90		
1426325	90		
1528106	90		
1762119	74		
1762120	74		
1762129	72,74		
1762130	72,74		
1762453	13		
1762625	13		
1762626	13		
1762670	74		
1762671	74		
1762674	74		
1762675	74		
1762846	13		
1762847	13		
1762950	13		
1762951	13		
1762952	13		
2047670	74		
2114042	13		
2114043	13		
2119141	13		
2119142	13		
2119143	13		
2119144	13		
2151018	39		
2151071	29		
2151073	39		
2151080	39		
2151082	13		
2151083	13		
2151086	81		
2151119	39		

Housing

Part Number	Page	Part Number	Page
175362	58,59	1827691	70
175363	58,59	1827862	15,16
177648	40,41	1827863	15,16
178127	46	1827864	19,20
178128	47,48,56,70	1871416	96,97
178129	50,51,56	1871417	96,97
178214	57	1871418	96,97
178288	40,41,43,46,69	1871419	96,97
178289	44,45	1871465	18
178802	40,41	1871946	25
178803	44,45	1903127	15,16
178964	44,45	1903128	15,16
179552	47,48	1903129	18
179553	47,48	1903130	19,20
179554	50,51,53,54	1903131	19,20
179555	50,51,53,54	1903146	87
179958	82,83,87,91	1903329	77
353046	82,83,88,89	1903330	77
353047	82,83,88,89	1903331	77
917241	58,59	1939758	14
917242	58,59	1939839	106
917249	57	1939850	106
917266	53,54	1971003	69
917659	50,51	1971150	24
917807	84,85,91	1971151	24
917808	84,85,88,89	1971182	24
917809	84,85,88,89	1971239	88
1318095	58,59	1981133	106
1318114	31,32	1981135	106
1318115	31,32	1981551	106
1318116	30	1981556	106
1318117	30	1981914	106
1318118	31,32	1981921	106
1318119	31,32	1981945	106
1318120	30	1981947	106
1318577	33	2013285	87
1318578	33	2013391	106
1376072	33	2013393	106
1376073	33	2040404	22,23
1376807	69	2040444	22,23
1473074	30	2069029	22
1473668	88	2069524	95
1747276	75,76	2069526	95
1747363	96,97	2069681	15,16
1747364	96,97	2069682	15,16
1747365	96	2134055	101
1747366	96	2134057	101
1747414	75,76	2134059	102
1747535	75,76	2134061	102
1747819	86	2291727	55
1747820	86	2291728	55
1747821	86	2333134	15,16
1747822	86	2333149	15,16
1827540	34	2349949	19,20
1827579	22,24	2350416	15,16

请使用互联网电子规格目录。
INTERNET Electronic Catalog Offered For Your Use.

www.te.com

本电子规格目录可根据“型号”“产品名称”“产品类型”等进行搜索，可在短时间内搜索到符合特定规格的产品。包括客户图纸在内，可简单提取到详细信息。采用时，请务必下载客户图纸后使用。

Using this Electronic Catalog, you can retrieve information by product category, part number and product name. It is possible to search and locate information on products that meet specific specifications in minutes. Customer drawings included, detailed product information can be extracted easily.

操作步骤
(Electronic Catalog Procedure)

可查阅RoHS标准。
You can search for the RoHS regulation information.

1 访问上述地址，出现右边的窗口：
Upon the access to our website, the following page will come appear.

2 光标对准产品信息，出现菜单。单击产品搜索，出现以下窗口，显示操作方法示例，请按需求方式进行搜索。
Moving the cursor here takes you to the product search menu. If you select the product search menu, the following page will show you examples of how to operate. Please operate with the suitable method to your needs.



单击此处，弹出右边窗口。
Click this button to get the page shown right.



输入产品型号，单击搜索，出现右边的窗口。(※171825-2为型号输入示例)
After entering part number, click Search to get the page shown right.
※171825-2 is an example of part number for entering.

Documents and Drawings for: 171825-2

Document Title	Document Type	Document ID	
171825-2 (171825-2) - Description 2 POS 058 FOOT HDR			
171825-2 (171825-2) - Description 2 POS 058 FOOT HDR	Product Specification	108-9130	<input type="checkbox"/>
171825-2 (171825-2) - Description 2 POS 058 FOOT HDR	Product Specification	108-9130	<input type="checkbox"/>
Customer Sales Sheet (171825-2) (171825-2)	Model	171825-2	<input type="checkbox"/>
Customer Sales Sheet (171825-2) (171825-2)	Model	171825-2	<input type="checkbox"/>
Customer Sales Sheet (171825-2) (171825-2)	Model	171825-2	<input type="checkbox"/>



- Product specifications may be changed for improvement purposes without prior notice. Sales of any of the products may be suspended. When discussing the use of products, be sure to request for the drawings and product Standard Type Type Types. In particular, please consult the information to confirm the tolerances of the fine mounting dimensions for the mounting of the printed circuit board.
- The product is provided with a sales batch. Please ask the sales department for the latest information.

- Dimensions, if not specified, are expressed in mm.
- The applicable wire range (AWG) contained in this specification catalogue covers the values for using the application tools. When using a hand tool, please refer to the operating manual.



TE.com

1-1773732-4 SL 08/2020

All rights reserved by © 2020 TE Connectivity and its affiliates.

“TE Connectivity,” “TE Connectivity (logo)” and “EVERY CONNECTION COUNTS” are trademarks.

Other logos and product and company names mentioned in this document are the trademarks of their respective owners.

TE has made every effort to ensure the accuracy of this product manual, but does not guarantee that there will be no errors in this document. No other statements or warranties are made regarding the accuracy, correctness, reliability or availability of the information.

TE reserves the right to make changes to the information contained in this document without prior notice. TE explicitly disclaims any implied warranties for the information contained in this catalog, including but not limited to the warranties of merchantability or fitness for a particular purpose. Dimensions in the catalog are for reference only and are subject to change without prior notice. Specifications are subject to change without prior notice. Please consult TE for the latest dimensions and design specifications.



单击下面可查看定价，库存，交付和生命周期等信息

[>>TE Connectivity\(泰科\)](#)