

LOC		DIST		REVISIONS			
P	LTN	DESCRIPTION	DATE	DMN	APVD		
A		RELEASED DRAWING	22DEC2015	TZ	SZ		
A1		ECR-16-017528	20DEC2016	TZ	SZ		
A2		ECR-17-003044	08MAR2017	TZ	SZ		

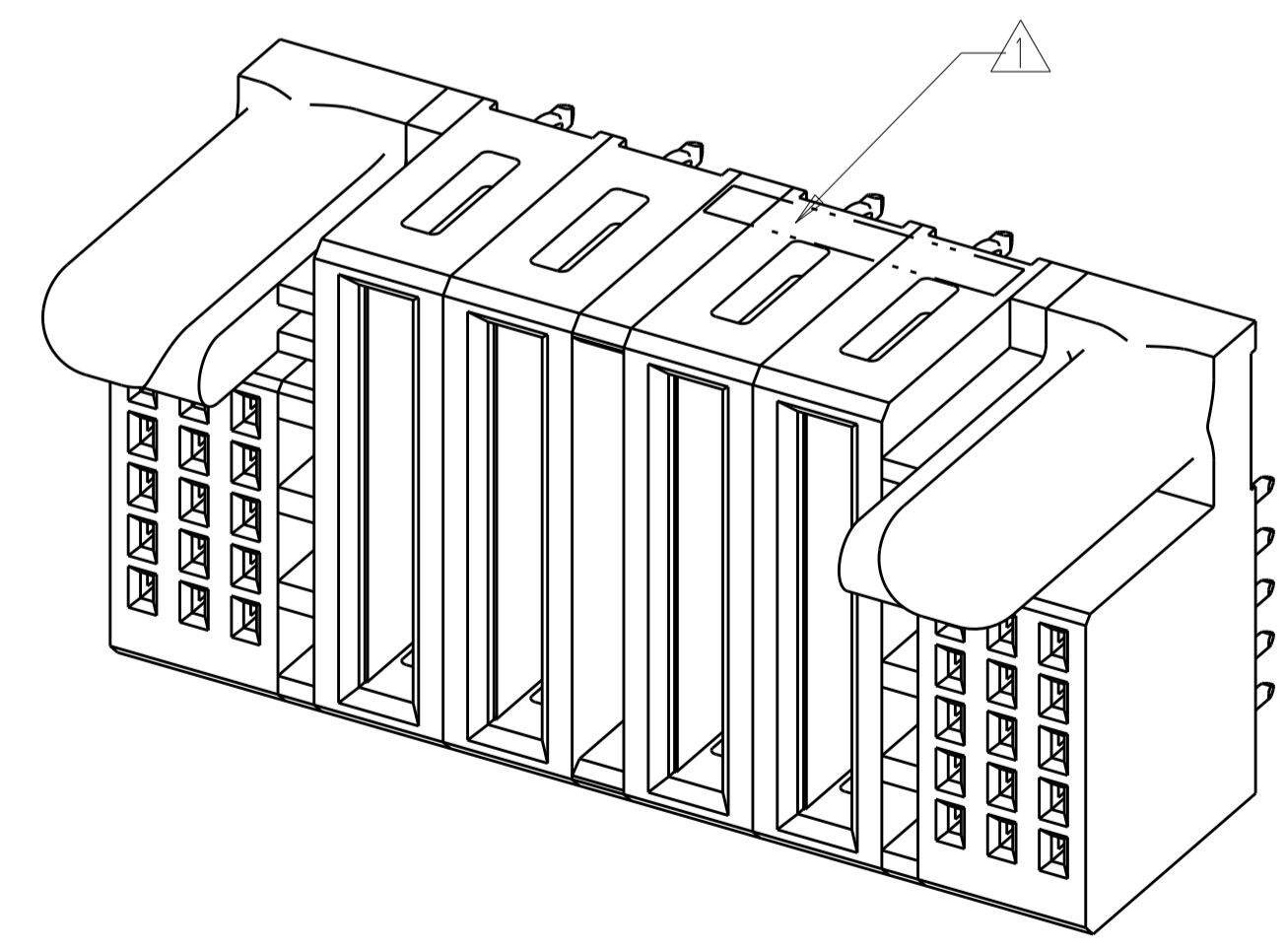
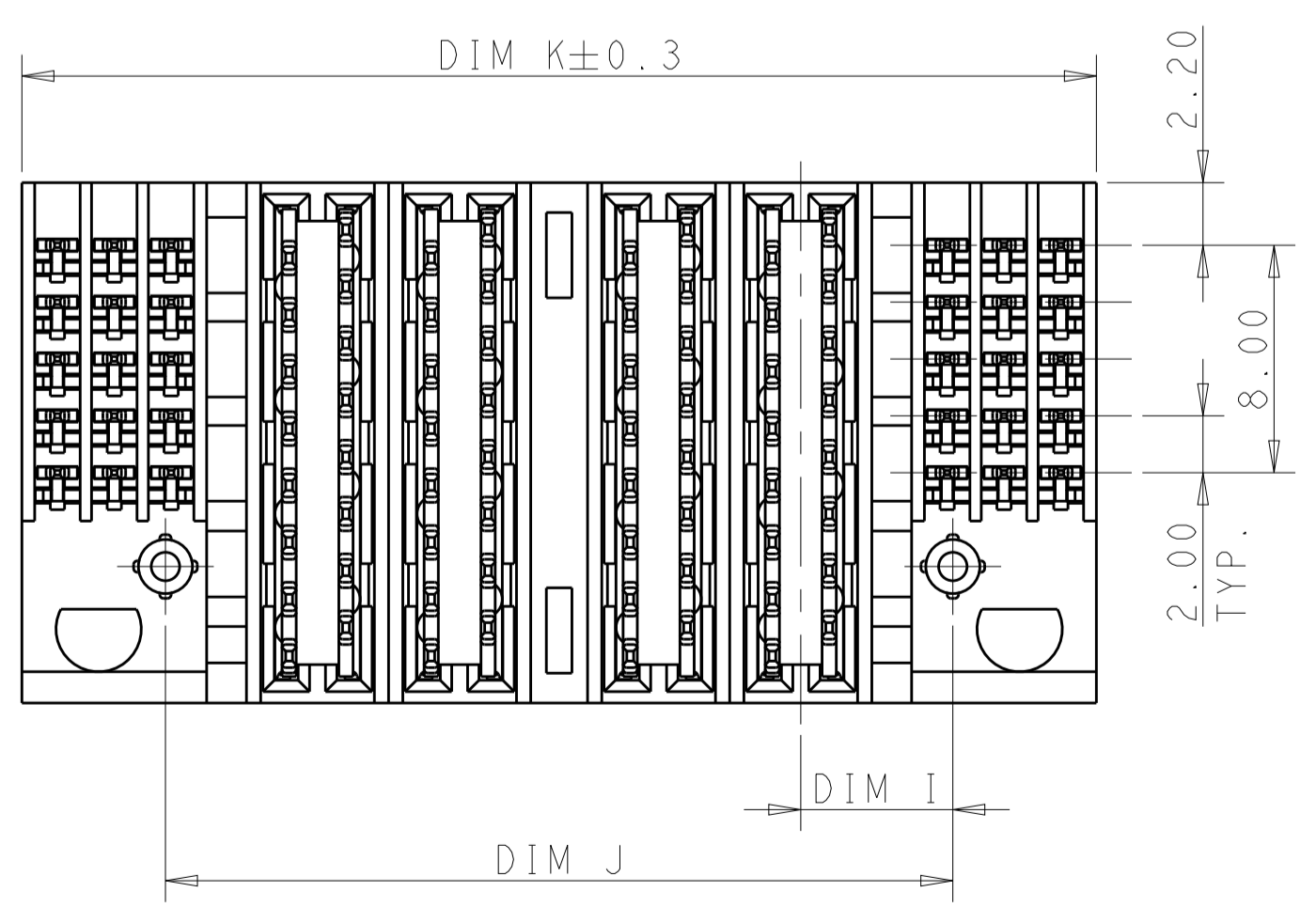
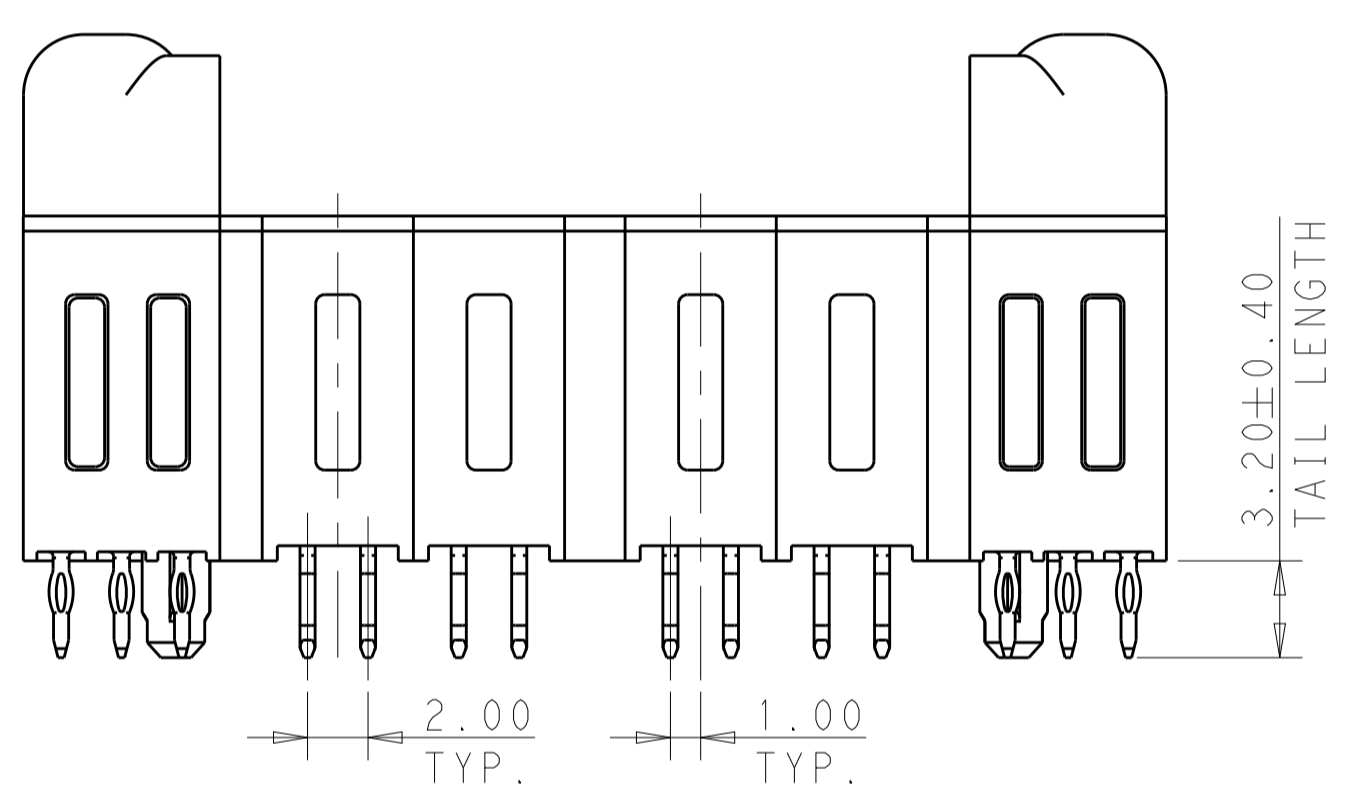
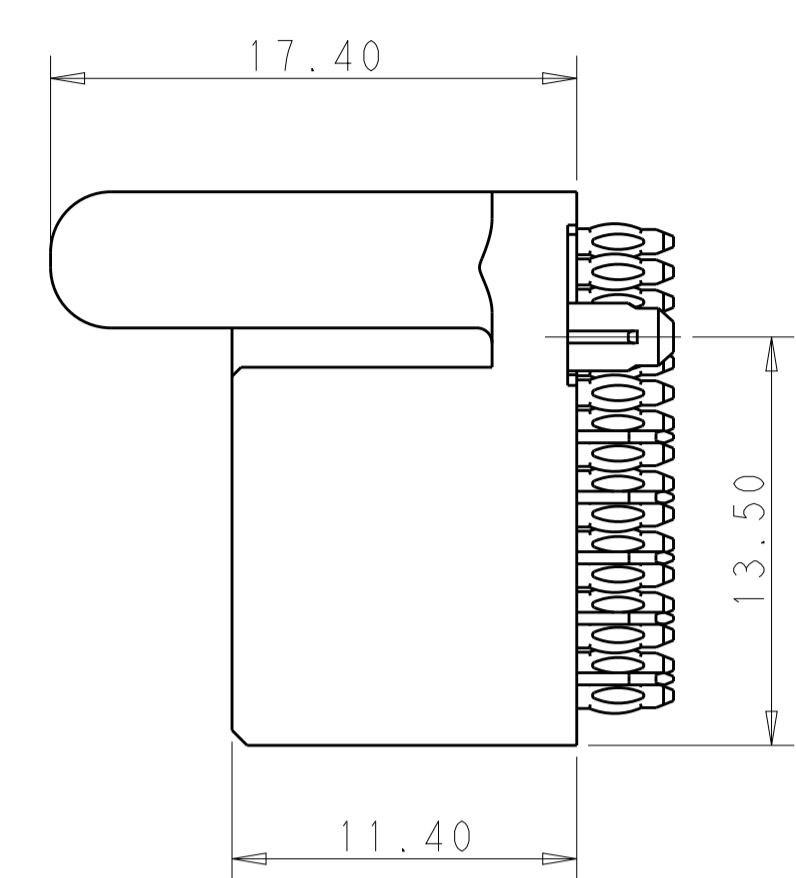
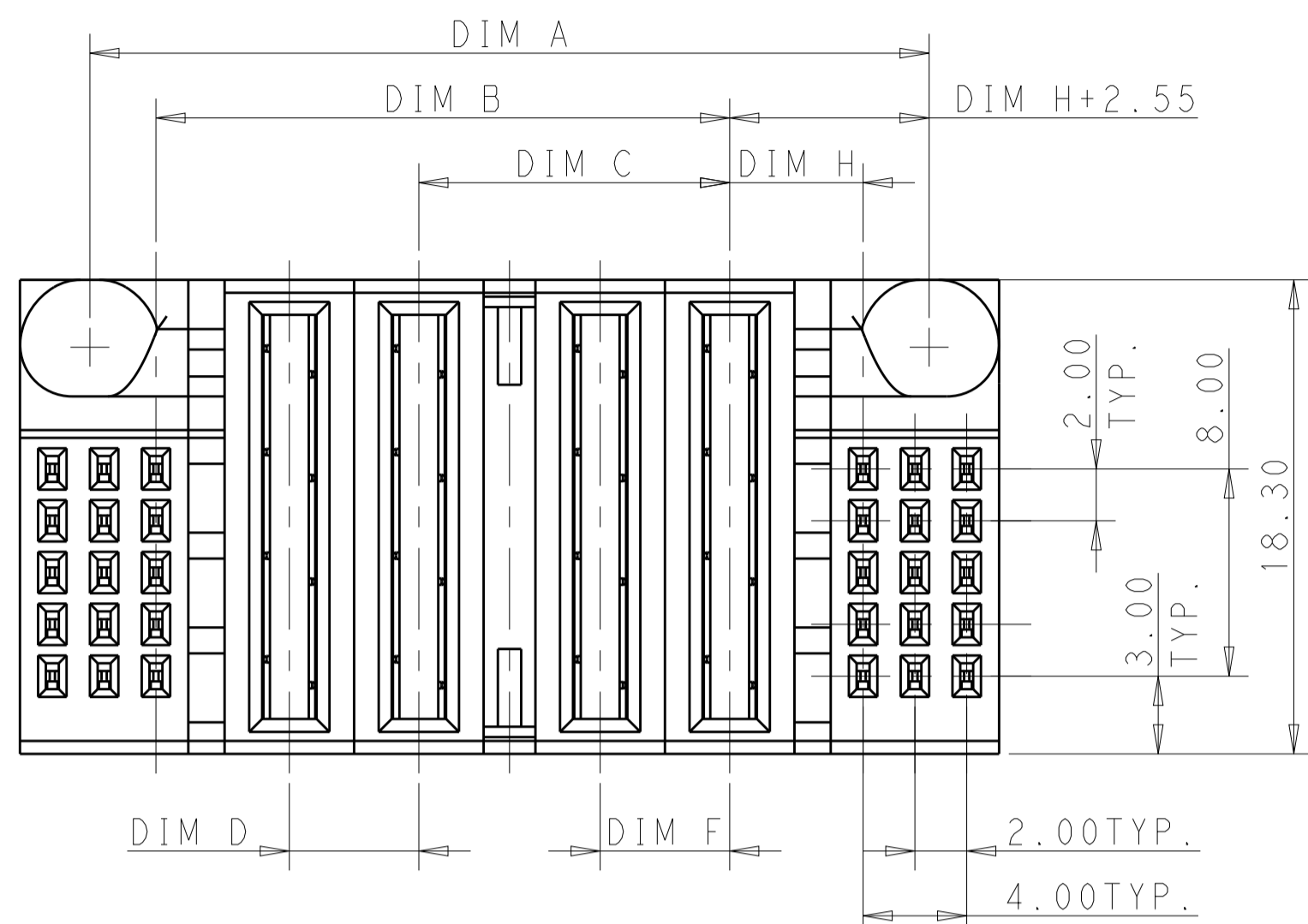

NOTES, UNLESS OTHERWISE SPECIFIED:

- ① "TE", PART NUMBER AND DATE CODE TO BE MARKED IN AREA SHOWN.
- ② MATERIAL:
  - HOUSING - GLASS FILLED HIGH TEMP THERMO PLASTIC, COLOR: BLACK, UL94 V- 0.
  - SIGNAL CONTACT - HIGH CONDUCTIVITY COPPER ALLOY.
  - POWER CONTACT - HIGH CONDUCTIVITY COPPER ALLOY.
- ③ CONTACT PLATING:
  - MATING AREA - NOBLE METAL OVERALL NICKEL
  - TAIL SIDE AREA - MATTE TIN OVERALL NICKEL.
- ④ MECHANICAL CONNECTOR KEEP OUT ZONE.
- ⑤ DATUM AND BASIC DIMENSIONS ESTABLISHED BY CUSTOMER.
- ⑥ PCB - ALL HOLE DIAMETERS ARE FINISHED HOLE SIZES.
- ⑦ PCB HOLE:
  - POWER - 1.15±0.025 MM DRILLED HOLES SIZE PLATING WITH 0.0076 MM MIN. Sn OVER 0.025-0.076 MM Cu PLATING TO ACHIEVE A 1.02 MM DIA. HOLE.
  - SIGNAL - 0.835±0.025 MM DRILLED HOLES SIZE PLATING WITH 0.0076 MM MIN. Sn OVER 0.025-0.076 MM Cu PLATING TO ACHIEVE A 0.72 MM DIA. HOLE.

THIS DRAWING IS A CONTROLLED DOCUMENT.		DMN THOMAS ZHAO 20DEC2012	TE Connectivity
DIMENSIONS: mm		CHK SUNY ZHAO 20DEC2012	
TOLERANCES UNLESS OTHERWISE SPECIFIED:		APVD SUNY ZHAO 20DEC2012	NAME Customer Drawing
0 PLC ±0.4		PRODUCT SPEC	VERTICAL RECEPTACLE
1 PLC ±0.4		APPLICATION SPEC	MULTI-BEAM HD S+P+P+S
2 PLC ±0.75		SIZE CAGE CODE DRAWING NO	A1 00779 C=2204420
3 PLC ±1.5		RESTRICTED TO	
4 PLC ±		WEIGHT	
ANGLES		CUSTOMER DRAWING	SCALE 4:1 SHEET 1 OF 7 REV A2
FINISH			

LOC		DIST		REVISIONS			
P	LTN	DESCRIPTION	DATE	DMN	APVD		
-	-	SEE SHEET 1	-	-	-		

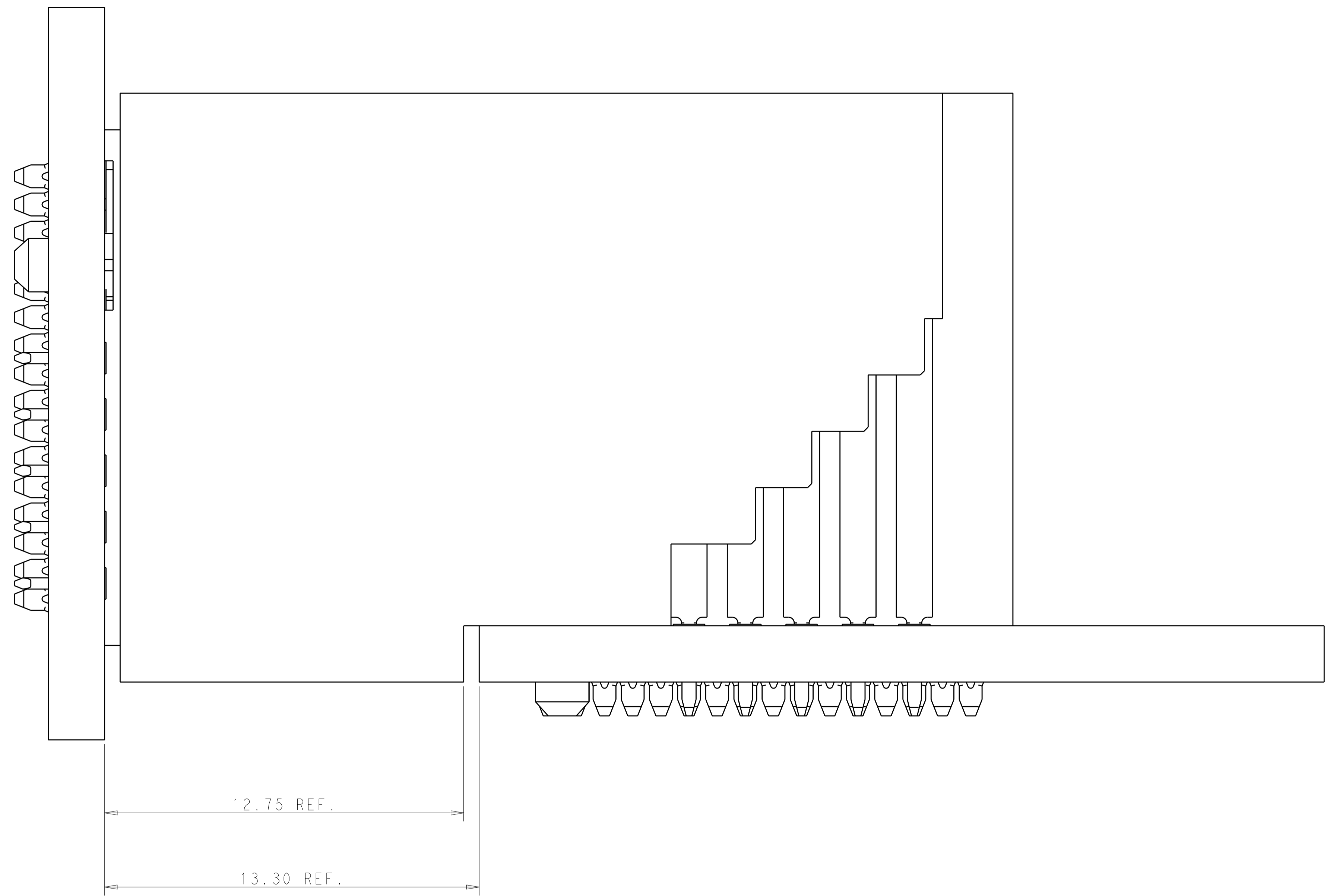

THE DISTANCE IS 0.05 MM MATING FACE FROM R/A HEADER TO VERTICAL RECEPTACLE.

THIS DRAWING IS A CONTROLLED DOCUMENT.		DMN THOMAS_ZHAO Z0DEC2012	<b>STE</b> TE Connectivity
DIMENSIONS: mm		CHK SUNY_ZHAO Z0DEC2012	
TOLERANCES UNLESS OTHERWISE SPECIFIED:		APVD SUNY_ZHAO Z0DEC2012	NAME Customer Drawing
0 PLC ±0.4		PRODUCT SPEC	VERTICAL RECEPTACLE
1 PLC ±0.4		APPLICATION SPEC	MULTI-BEAM HD S+P+S
2 PLC ±0.75		RESTRICTED TO	
3 PLC ±1.15		SIZE CAGE CODE DRAWING NO	A100779C=2204420
4 PLC ±	FINISH	WEIGHT	SCALE 4:1 SHEET 2 OF 7 REV A2
ANGLES ±	MATERIAL	CUSTOMER DRAWING	

LOC	DIST	REVISIONS			
P	LTN	DESCRIPTION	DATE	DMN	APVD
-	-	SEE SHEET 1	-	-	-

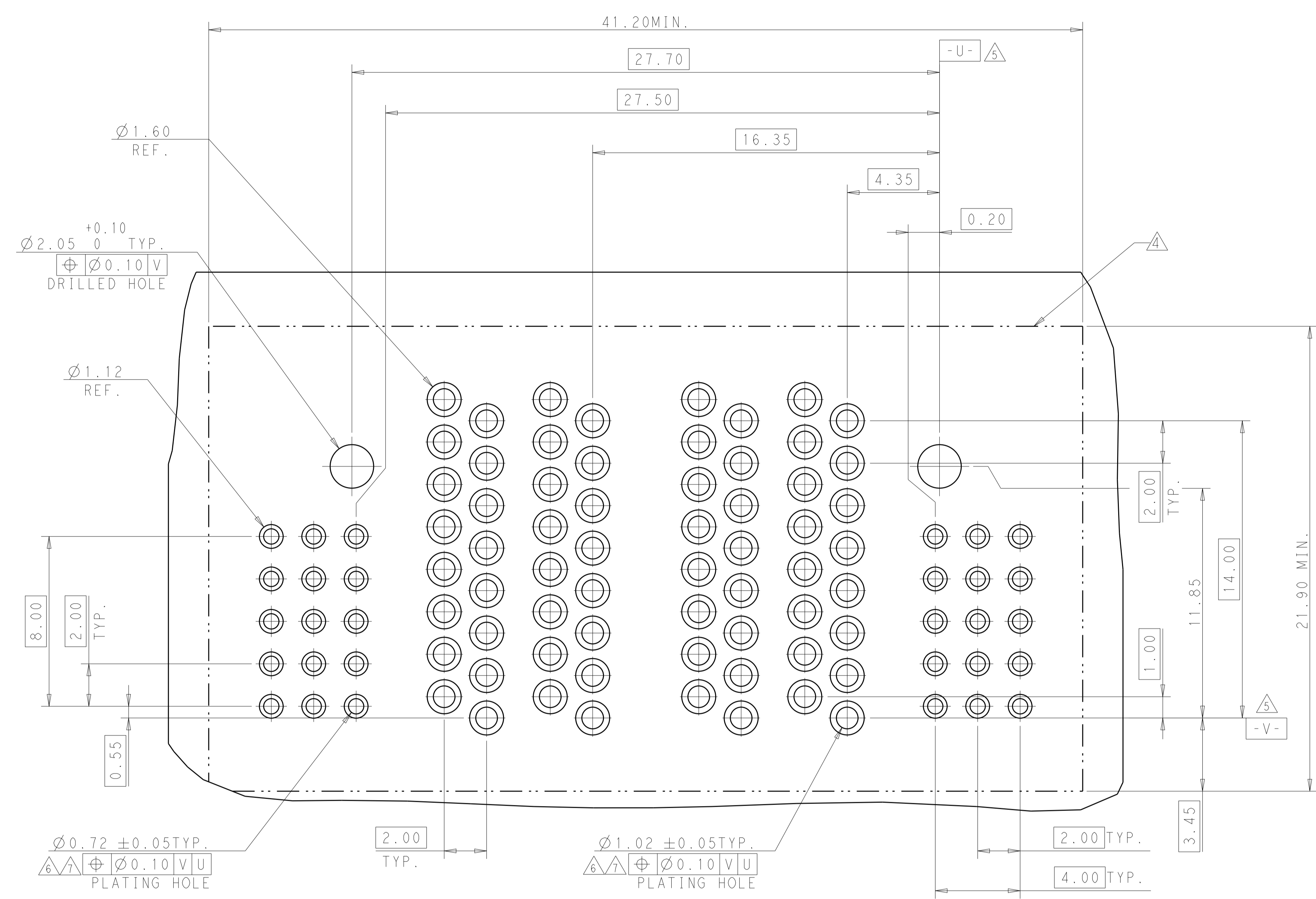

PART NUMBER	ROWS	SIGNAL			POWER				SIGNAL		
		6	5	4	P4	P3	P2	P1	3	2	1
2204420-1	E	SM	SM	SM	PM	PM	PM	PM	SM	SM	SM
	D	SM	SM	SM					SM	SM	SM
	C	SM	SM	SM					SM	SM	SM
	B	SM	SM	SM					SM	SM	SM
	A	SM	SM	SM					SM	SM	SM

15S+2P+2P+15S

DIM A	DIM B	DIM C	DIM D	DIM E	DIM F	DIM H	DIM I	DIM J	DIM K	DESCRIPTION	PART NUMBER
42.40	32.15	17.00	5.00	5.00	5.15	5.35	37.70	47.80	15S+3P+3P+15S	1-2204420-1	
50.40	40.15	21.00	7.00	7.00	5.15	5.35	45.70	55.80	15S+3HVP+3HVP+15S	1-2204420-0	
42.40	32.15	17.00	5.00	5.00	5.15	5.35	37.70	47.80	15S+3P+3P+15S	2204420-9	
19.40	15.15	-	-	5.00	5.15	5.35	20.70	30.80	15S+3P+12S	2204420-8	
22.40	12.15	7.00	-	-	5.15	5.35	17.70	27.80	15S+1P+1P+15S	2204420-6/7	
62.40	52.15	27.00	5.00	5.00	5.15	5.35	57.70	67.80	10S+5P+5P+10S	2204420-5	
92.40	82.15	42.00	5.00	5.00	5.15	5.35	87.70	97.80	15S+8P+8P+15S	2204420-3	
78.40	68.15	42.00	7.00	5.00	5.15	5.35	73.70	83.80	15S+8P+4P+15S	2204420-2	
32.40	22.15	12.00	5.00	5.00	5.15	5.35	27.70	37.80	15S+2P+2P+15S	2204420-1	

THIS DRAWING IS A CONTROLLED DOCUMENT. DWG: THOMAS\_ZHAO\_Z0DEC2012, CHK: SUNY\_ZHAO\_Z0DEC2012, APVD: SUNY\_ZHAO\_Z0DEC2012

**STE** TE Connectivity

Customer Drawing  
VERTICAL RECEPTACLE  
MULTI-BEAM HD S+P+P+S

SCALE: 4:1 SHEET 3 OF 7 REV A2

LOC	DIST	REV	DATE	BY	APPV
		1			

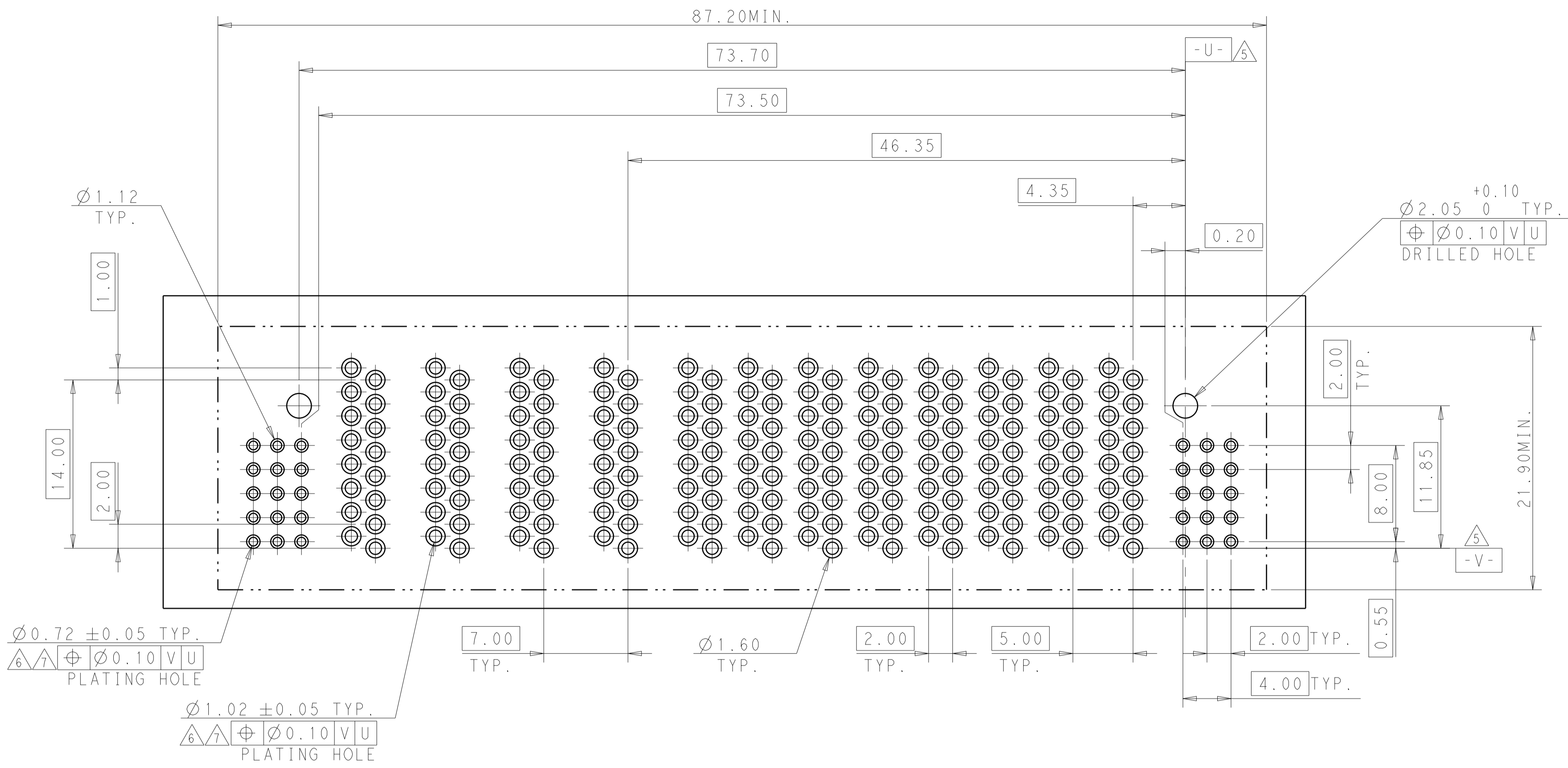

PART NUMBER	ROWS	SIGNAL			POWER											SIGNAL															
		6	5	4	PI2	PI1	PI0	P9	P8	P7	P6	P5	P4	P3	P2	PI	3	2	1												
2204420-2	E	[Diagram]			PM	PM	PM	PM	PM	PM	PM	PM	PM	PM	PM	PM	[Diagram]														
	D	SMI	SMI	SMI													SMI	SMI	SMI	SMI	SMI	SMI	SMI	SMI	SMI	SMI	SMI	SMI	SMI	SMI	
	C	SMI	SMI	SMI													SMI	SMI	SMI	SMI	SMI	SMI	SMI	SMI	SMI	SMI	SMI	SMI	SMI	SMI	SMI
	B	SMI	SMI	SMI													SMI	SMI	SMI	SMI	SMI	SMI	SMI	SMI	SMI	SMI	SMI	SMI	SMI	SMI	SMI
	A	SMI	SMI	SMI													SMI	SMI	SMI	SMI	SMI	SMI	SMI	SMI	SMI	SMI	SMI	SMI	SMI	SMI	SMI
15S+8HP+4HP+15S																															

SIGNAL CONTACT	SMI
POWER CONTACT STANDARD	PN
POWER CONTACT MFBL	PM
DESCRIPTION	IDENTIFIER

THIS DRAWING IS A CONTROLLED DOCUMENT.		OWN: THOMAS ZHAO Z0DEC2012		TE Connectivity
DIMENSIONS: mm		CHK: SUNY ZHAO Z0DEC2012		NAME: Customer Drawing
TOLERANCES UNLESS OTHERWISE SPECIFIED:		APVD: SUNY ZHAO Z0DEC2012	PRODUCT SPEC: VERTICAL RECEPTACLE	
0 PLC ±0.4		APPLICATION SPEC: MULTI-BEAM HD S+P+P+S		
1 PLC ±0.4		SIZE: A100779C=2204420		
2 PLC ±0.75		WEIGHT: -		
3 PLC ±1.5		SCALE: 4:1		
4 PLC ±		SHEET: 4 OF 7		
ANGLES ±		REV: A2		
FINISH		CUSTOMER DRAWING		

LOC	DIST	REVISIONS			
P	LTN	DESCRIPTION	DATE	DWN	APVD
-	-	SEE SHEET 1	-	-	-

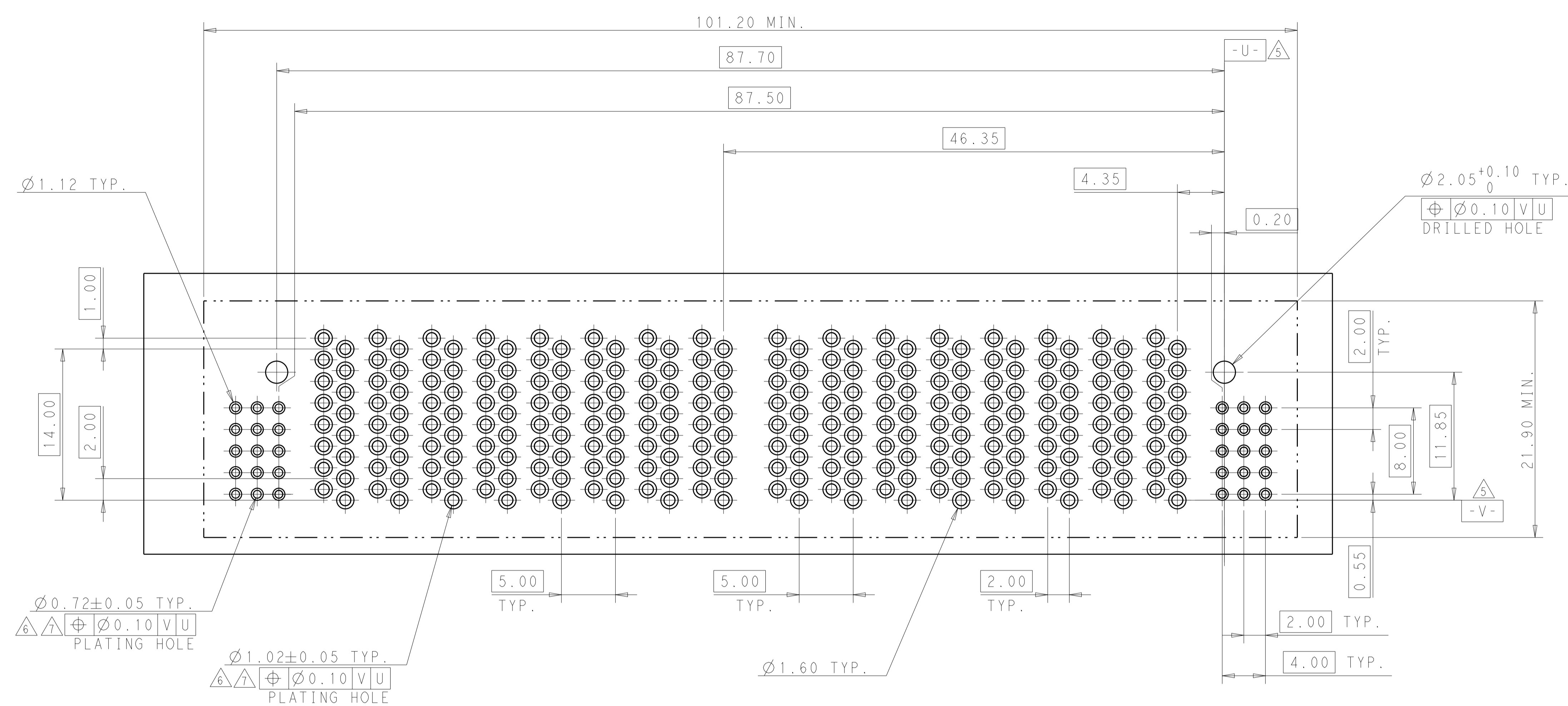

PART NUMBER	ROWS	SIGNAL			POWER														SIGNAL																						
		6	5	4	PI6	PI5	PI4	PI3	PI2	PI1	PI0	P9	P8	P7	P6	P5	P4	P3	P2	PI	3	2	1																		
2204420-3	E D C B A				PM	PM	PM	PM	PM	PM	PM	PM	PM	PM	PM	PM	PM	PM	PM	PM	PM																				
																									SMI	SMI	SMI	SMI	SMI	SMI	SMI	SMI	SMI	SMI	SMI	SMI	SMI	SMI	SMI	SMI	SMI
		SMI	SMI	SMI																		SMI	SMI	SMI	SMI	SMI	SMI	SMI	SMI	SMI	SMI	SMI	SMI	SMI	SMI	SMI	SMI	SMI	SMI	SMI	SMI
		SMI	SMI	SMI																		SMI	SMI	SMI	SMI	SMI	SMI	SMI	SMI	SMI	SMI	SMI	SMI	SMI	SMI	SMI	SMI	SMI	SMI	SMI	SMI
		SMI	SMI	SMI																		SMI	SMI	SMI	SMI	SMI	SMI	SMI	SMI	SMI	SMI	SMI	SMI	SMI	SMI	SMI	SMI	SMI	SMI	SMI	SMI
		SMI	SMI	SMI																		SMI	SMI	SMI	SMI	SMI	SMI	SMI	SMI	SMI	SMI	SMI	SMI	SMI	SMI	SMI	SMI	SMI	SMI	SMI	SMI
15S+8HP+8HP+15S																																									

THIS DRAWING IS A CONTROLLED DOCUMENT.

DIMENSIONS:	TOLERANCES UNLESS OTHERWISE SPECIFIED:	DWN THOMAS_ZHAO Z0DEC2012	
mm	0 PLC ±0.4 1 PLC ±0.4 2 PLC ±0.75 3 PLC ±1.15 4 PLC ±1.5 ANGLES ±°	CHK SUNY_ZHAO Z0DEC2012	
MATERIAL	FINISH	APVD SUNY_ZHAO Z0DEC2012	NAME Customer Drawing
		PRODUCT SPEC	VERTICAL RECEPTACLE
		APPLICATION SPEC	MULTI-BEAM HD S+P+P+S
		WEIGHT	SIZE CAGE CODE DRAWING NO RESTRICTED TO
		CUSTOMER DRAWING	A100779C=2204420
		SCALE 4:1	SHEET 5 OF 7 REV A2

LOC	DIST	REV	DATE	BY	APPV
		1			
		2			

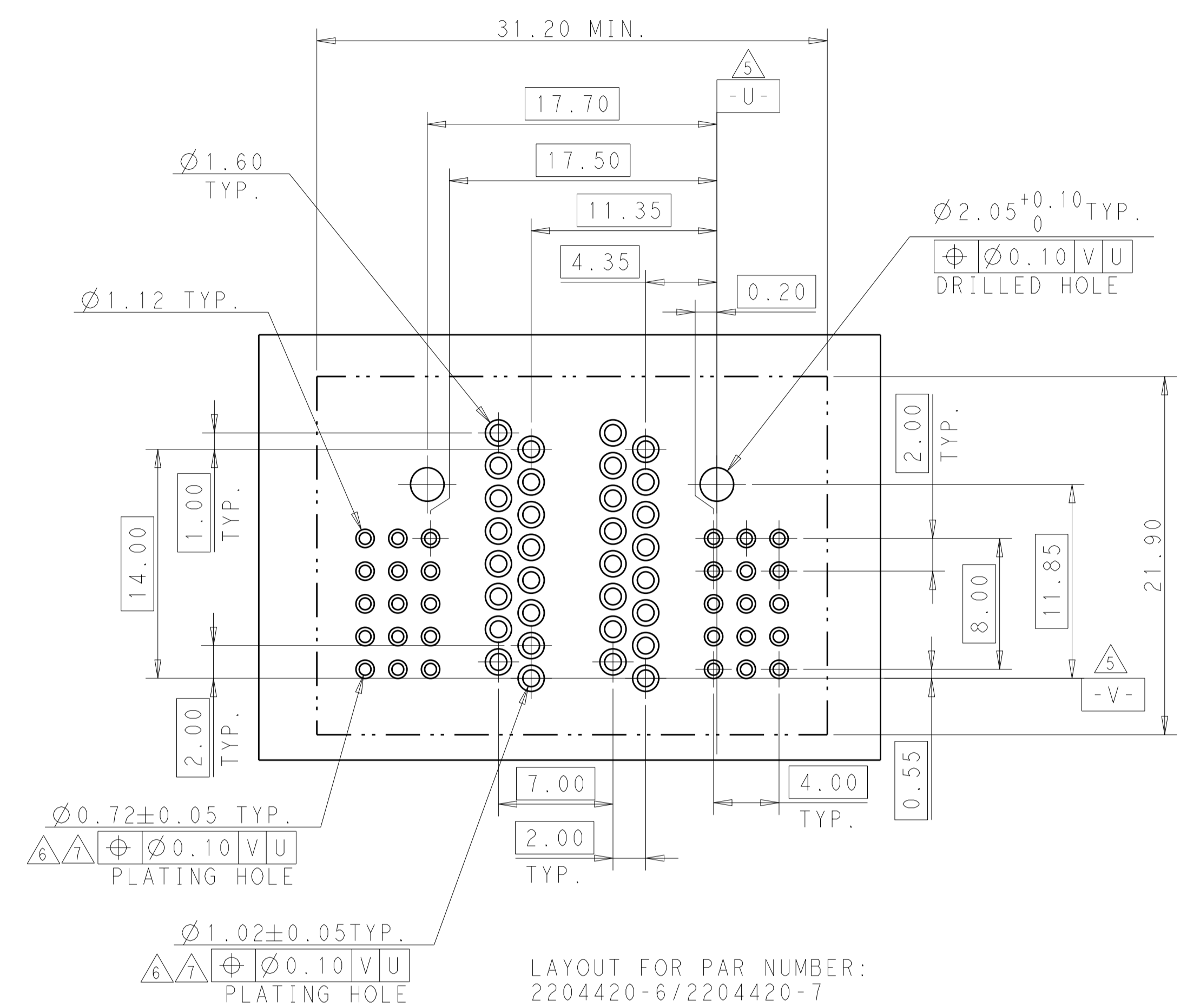
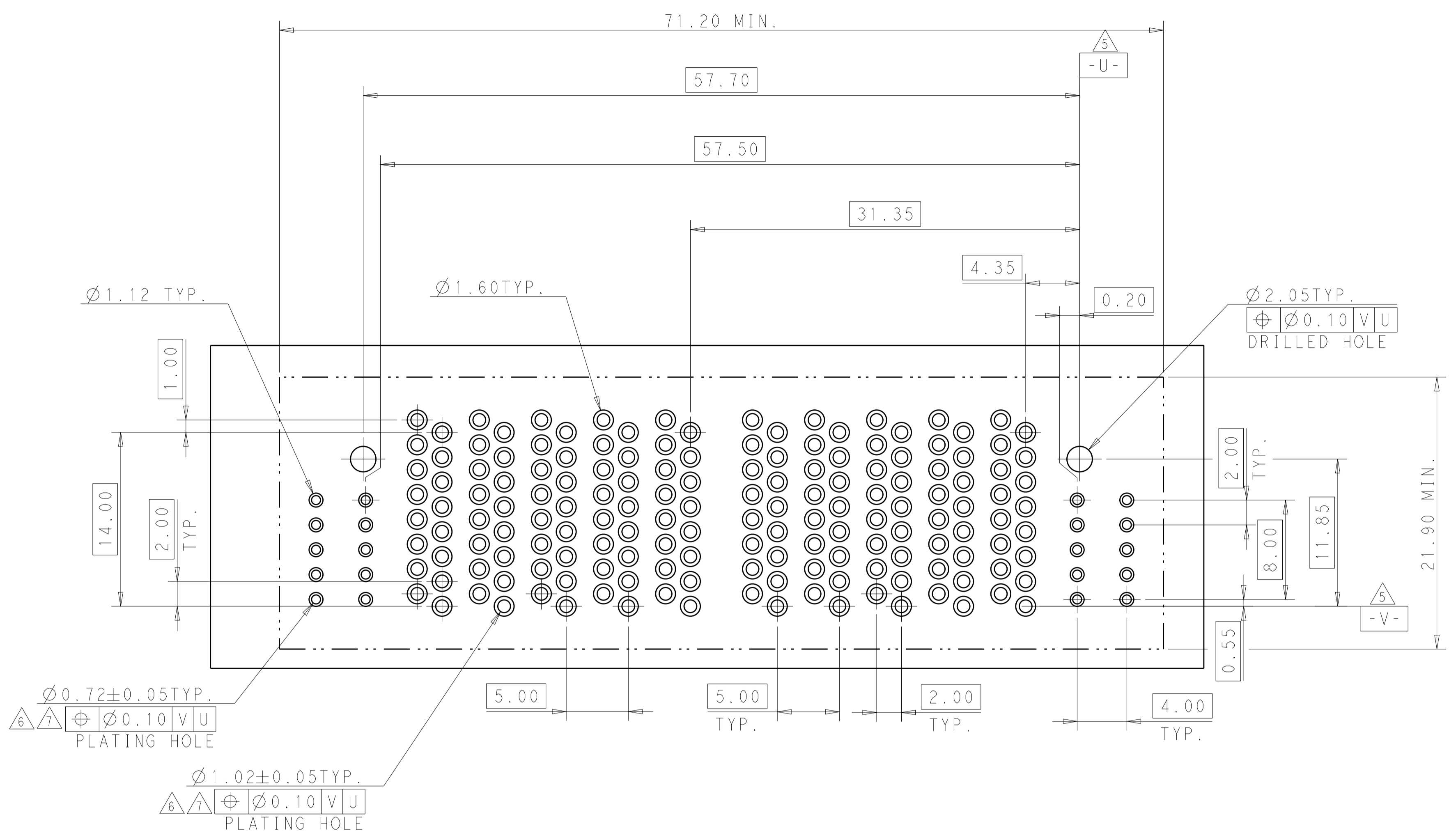

LAYOUT FOR PAR NUMBER:  
2204420-6/2204420-7

PART NUMBER	ROWS	SIGNAL		POWER								SIGNAL				
		4	3	P10	P9	P8	P7	P6	P5	P4	P3	P2	P1	2	1	
2204420-5	E	SMI	SMI	PM	PM	PM	PM	PM	PM	PM	PM	PM	SMI	SMI		
	D	SMI	SMI												SMI	SMI
	C	SMI	SMI												SMI	SMI
	B	SMI	SMI												SMI	SMI
	A	SMI	SMI												SMI	SMI
10S+5HP+5HP+10S																

PART NUMBER	ROWS	SIGNAL			POWER		SIGNAL		
		6	5	4	P2	P1	3	2	1
2204420-6	E	SMI	SMI	SMI	PM	PM	SMI	SMI	SMI
	D	SMI	SMI	SMI			SMI	SMI	SMI
	C	SMI	SMI	SMI			SMI	SMI	SMI
	B	SMI	SMI	SMI			SMI	SMI	SMI
	A	SMI	SMI	SMI			SMI	SMI	SMI
15S+1P+1P+15S									

PART NUMBER	ROWS	SIGNAL			POWER		SIGNAL		
		6	5	4	P2	P1	3	2	1
2204420-7	E	SMI	SMI	SMI	PM	PM	SMI	SMI	SMI
	D	SMI	SMI	SMI			SMI	SMI	SMI
	C	SMI	SMI	SMI			SMI	SMI	SMI
	B	SMI	SMI	SMI			SMI	SMI	SMI
	A	SMI	SMI	SMI			SMI	SMI	SMI
15S+1P+1P+12S									

THIS DRAWING IS A CONTROLLED DOCUMENT. DWG: THOMAS\_ZHAO\_20DEC2012, CHK: SUNY\_ZHAO\_20DEC2012, APPV: SUNY\_ZHAO\_20DEC2012

**STE** TE Connectivity

Customer Drawing  
VERTICAL RECEPTACLE  
MULTI-BEAM HD S+P+P+S

SIZE: A1 00779 C=2204420

SCALE: 4:1 SHEET: 6 OF 7 REV: A2

PART NUMBER	ROWS	SIGNAL			POWER			SIGNAL		
		6	5	4	P3	P2	P1	3	2	1
2204420-8	E	SMI	SMI	SMI	PM	PM	PM	SMI	SMI	SMI
	D	SMI	SMI	SMI				SMI	SMI	SMI
	C	SMI	SMI	SMI				SMI	SMI	SMI
	B	SMI	SMI	SMI				SMI	SMI	SMI
A	SMI	SMI	SMI	SMI	SMI	SMI	SMI	SMI	SMI	
15S+3P+12S										

PART NUMBER	ROWS	SIGNAL			POWER						SIGNAL		
		6	5	4	P6	P5	P4	P3	P2	P1	3	2	1
2204420-9	E	SMI	SMI	SMI	PM	PM	PM	PM	PM	PM	SMI	SMI	SMI
	D	SMI	SMI	SMI							SMI	SMI	SMI
	C	SMI	SMI	SMI							SMI	SMI	SMI
	B	SMI	SMI	SMI							SMI	SMI	SMI
A	SMI	SMI	SMI	SMI	SMI	SMI	SMI	SMI	SMI				
15S+3P+3P+15S													

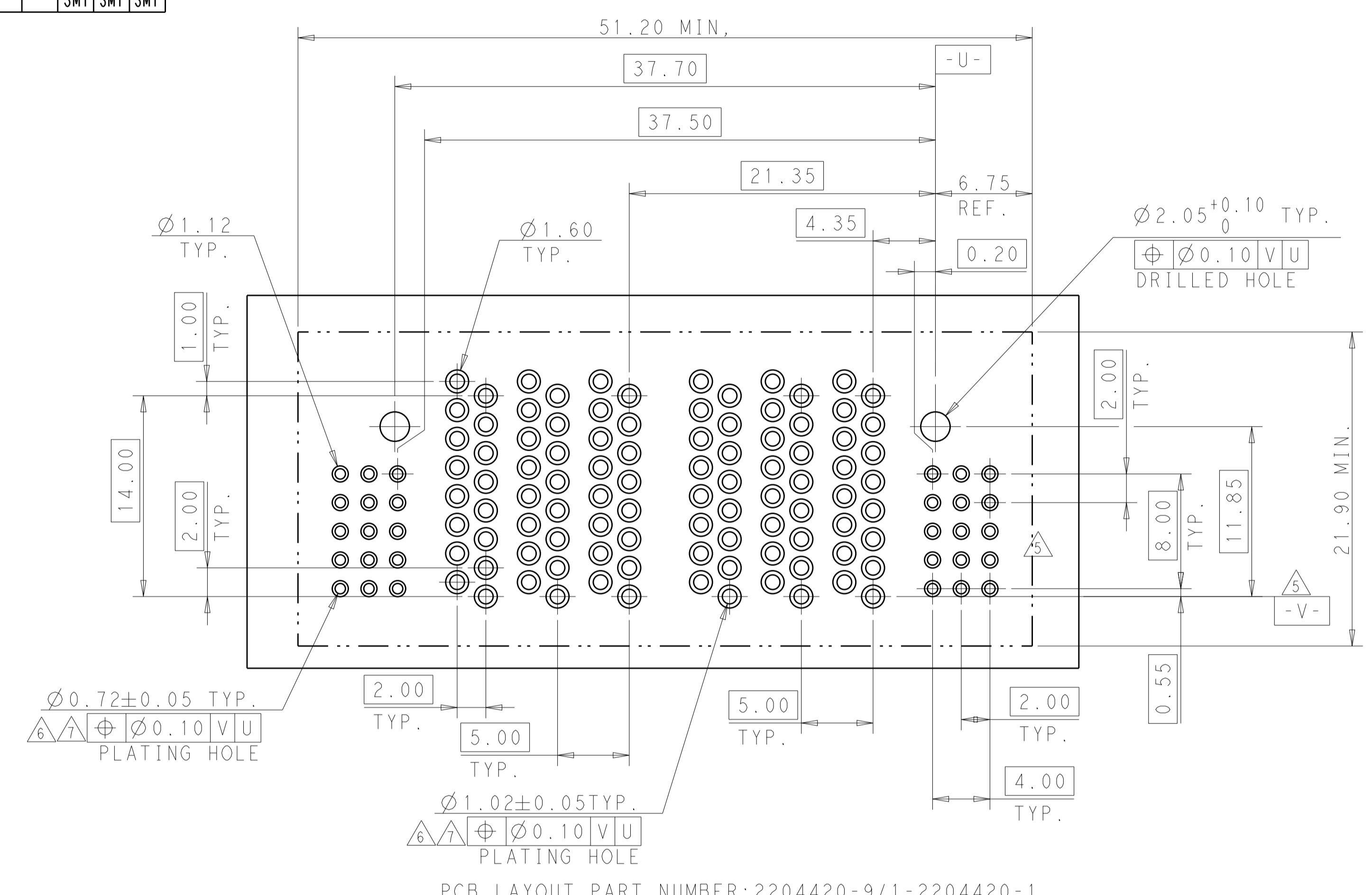
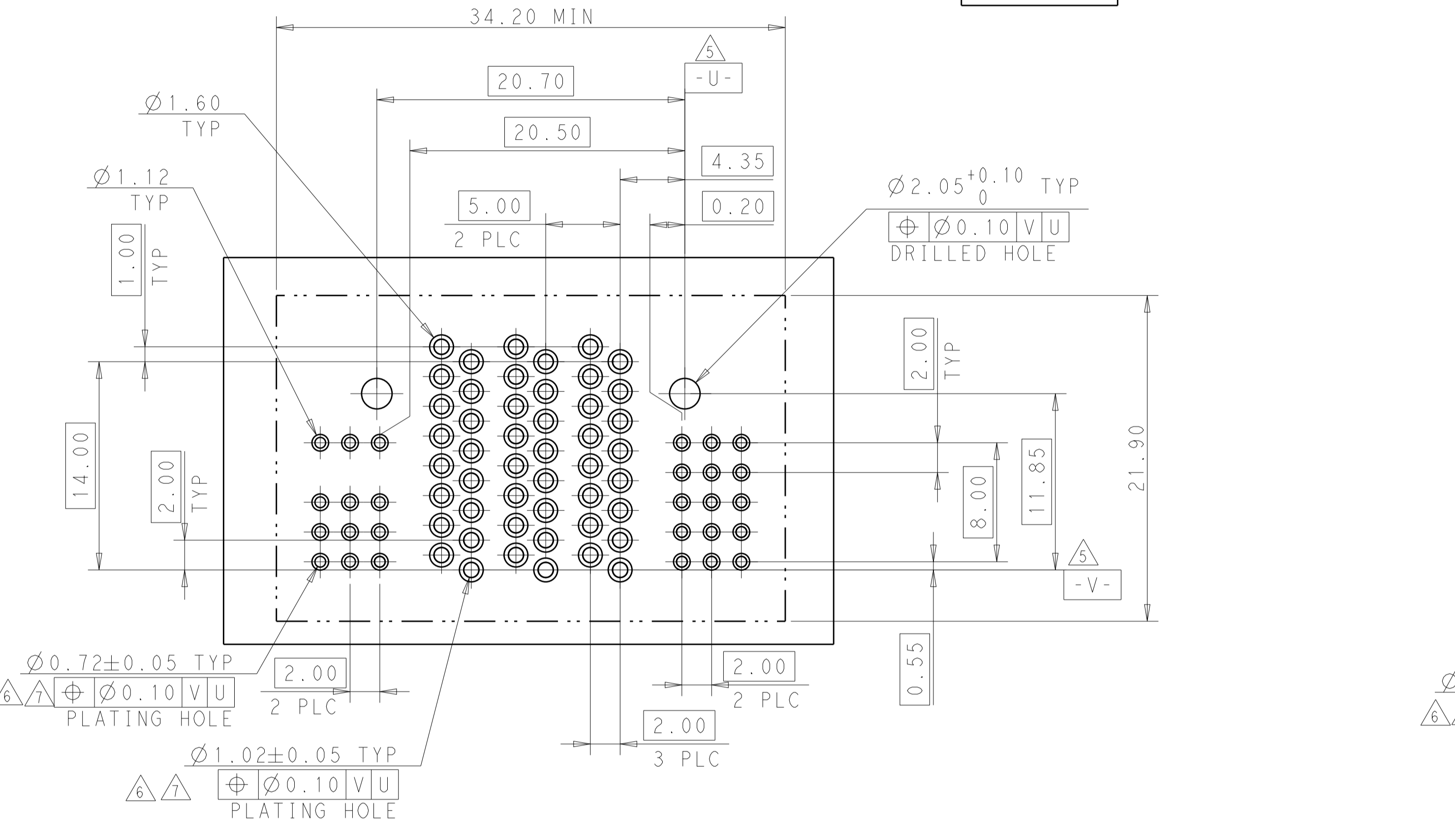

PCB LAYOUT PART NUMBER: 2204420-9/1-2204420-1

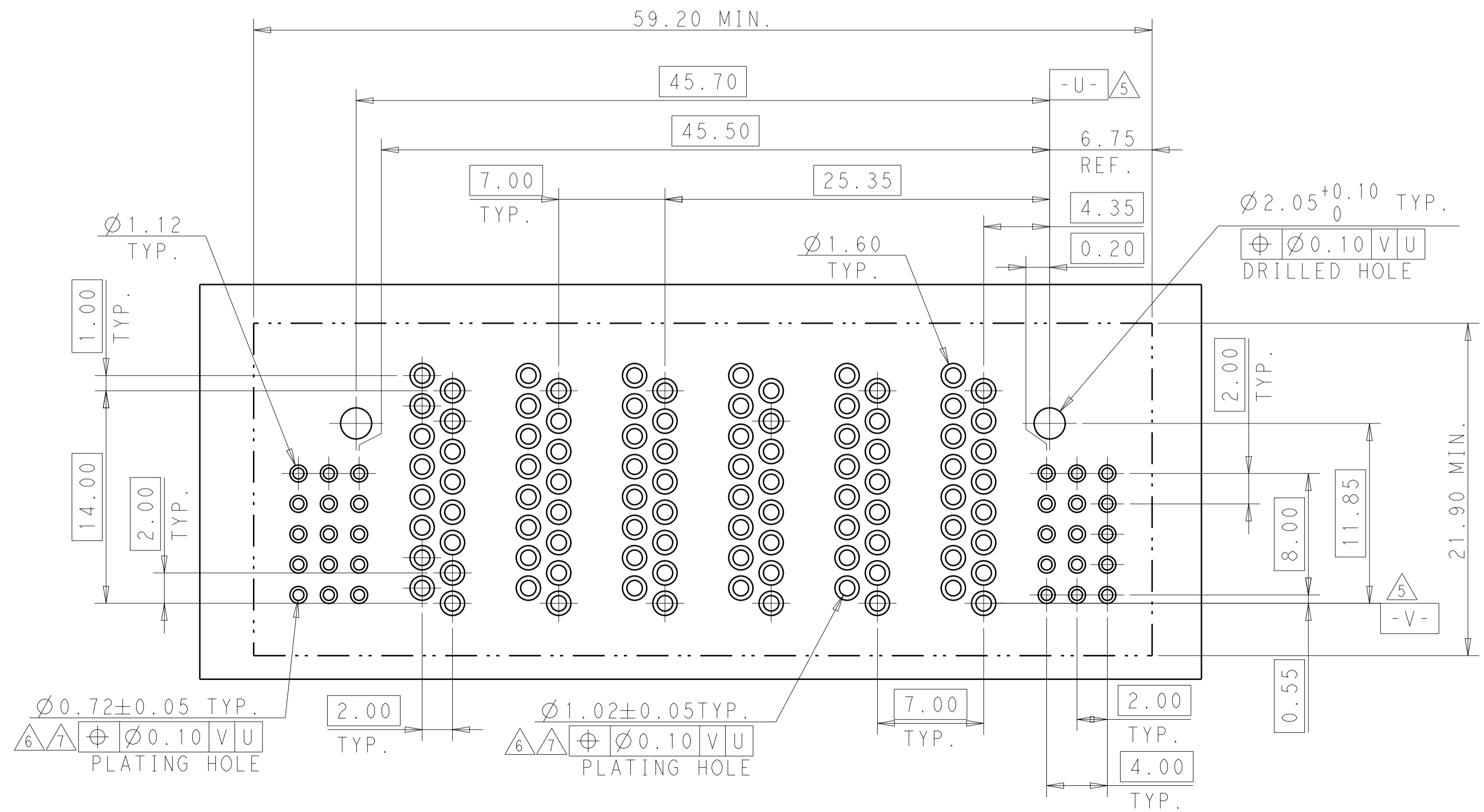

PART NUMBER	ROWS	SIGNAL			POWER						SIGNAL		
		6	5	4	P6	P5	P4	P3	P2	P1	3	2	1
1-2204420-0	E	SMI	SMI	SMI	PM	PM	PM	PM	PM	PM	SMI	SMI	SMI
	D	SMI	SMI	SMI							SMI	SMI	SMI
	C	SMI	SMI	SMI							SMI	SMI	SMI
	B	SMI	SMI	SMI							SMI	SMI	SMI
A	SMI	SMI	SMI	SMI	SMI	SMI	SMI	SMI					
15S+3HVP+3HVP+15S													

PART NUMBER	ROWS	SIGNAL			POWER						SIGNAL		
		6	5	4	P6	P5	P4	P3	P2	P1	3	2	1
1-2204420-1	E	SMI	SMI	SMI	PM	PM	PM	PN	PN	PN	SMI	SMI	SMI
	D	SMI	SMI	SMI							SMI	SMI	SMI
	C	SMI	SMI	SMI							SMI	SMI	SMI
	B	SMI	SMI	SMI							SMI	SMI	SMI
A	SMI	SMI	SMI	SMI	SMI	SMI	SMI	SMI					
15S+3P+3P+15S													

THIS DRAWING IS A CONTROLLED DOCUMENT. DWN: THOMAS ZHAO, Z0DEC2012  
 CHK: SUNY ZHAO, Z0DEC2012  
 APVD: SUNY ZHAO, Z0DEC2012  
 NAME: Customer Drawing  
 PRODUCT SPEC: VERTICAL RECEPTACLE  
 APPLICATION SPEC: MULTI-BEAM HD S+P+P+S  
 SIZE: A1, CAGE CODE: 2204420, DRAWING NO: 100779, SHEET 7 OF 7, REV A2  
 MATERIAL: -  
 FINISH: -  
 WEIGHT: -  
 CUSTOMER DRAWING  
 SCALE: 4:1

单击下面可查看定价，库存，交付和生命周期等信息

[>>TE Connectivity\(泰科\)](#)